

DOCUMENT RESUME

ED 119 884

RC 009 024

TITLE Arizona TeleMedicine Network: System Procurement Specifications, Phase 1.

INSTITUTION Arizona Univ., Tucson. Coll. of Medicine.; Atlantic Research Corp., Alexandria, Va.

SPONS AGENCY Office of Economic Opportunity, Washington, D.C.

REPORT NO OEO-B2C-5379

PUB DATE 31 Dec 72

NOTE 234p.; Some photographs, maps, and charts may not reproduce clearly due to marginal quality of original; Related documents are RC 009 023-027

EDRS PRICE MF-\$0.83 HC-\$12.71 Plus Postage

DESCRIPTORS \*American Indians; Contracts; Delivery Systems; Design; Equipment; \*Health Services; Maps; Mobile Laboratories; Performance Specifications; Photographs; Quality Control; Reservations (Indian); \*Rural Areas; \*Specifications; Technology; \*Telecommunication

IDENTIFIERS \*Arizona Telemedicine Project

ABSTRACT

Defining the system procurement specifications for a telecommunications system designed to provide health services to rurally isolated American Indians living on reservations in Arizona, this document presents detailed specifications for: (1) a complete communications facility; (2) a mobile health communications treatment and diagnosis unit; (3) clinical components (X-ray, laboratory, and examination equipment); and (4) various related professional services. Major sections of this document include: (1) Scope; (2) System Design (purpose; design objectives; geographic scope; information handling; selection of microwave routes; signal routing, system management, and switching; control console equipment; equipment licensing; radio frequency channel assignments); (3) Applicable Documents; (4) Transmission Performance Requirements (voice bandwidth channels, telemetry channel, television channels); (5) Equipment Performance Requirements (video; audio; multiplex channel; microwave radio; teleprinter; slow-scan television); (6) Mobile Unit and Support Relay; (7) Other Technical Requirements (equipment shelters, appurtenances, and radomes); (8) Quality Assurance (testing and testing procedures); (9) General Conditions and Instructions to Contractor; (10) Appendices (path profiles; site maps and photographs; drawings). (JC)

\*\*\*\*\*

\* Documents acquired by ERIC include many informal unpublished \*  
 \* materials not available from other sources. ERIC makes every effort \*  
 \* to obtain the best copy available. Nevertheless, items of marginal \*  
 \* reproducibility are often encountered and this affects the quality \*  
 \* of the microfiche and hardcopy reproductions ERIC makes available \*  
 \* via the ERIC Document Reproduction Service (EDRS). EDRS is not \*  
 \* responsible for the quality of the original document. Reproductions \*  
 \* supplied by EDRS are the best that can be made from the original. \*

\*\*\*\*\*

ED119884

# Arizona TeleMedicine Network

U.S. DEPARTMENT OF HEALTH,  
EDUCATION & WELFARE  
NATIONAL INSTITUTE OF  
EDUCATION

THIS DOCUMENT HAS BEEN REPRODUCED EXACTLY AS RECEIVED FROM THE PERSON OR ORGANIZATION ORIGINATING IT. POINTS OF VIEW OR OPINIONS STATED DO NOT NECESSARILY REPRESENT OFFICIAL NATIONAL INSTITUTE OF EDUCATION POSITION OR POLICY.

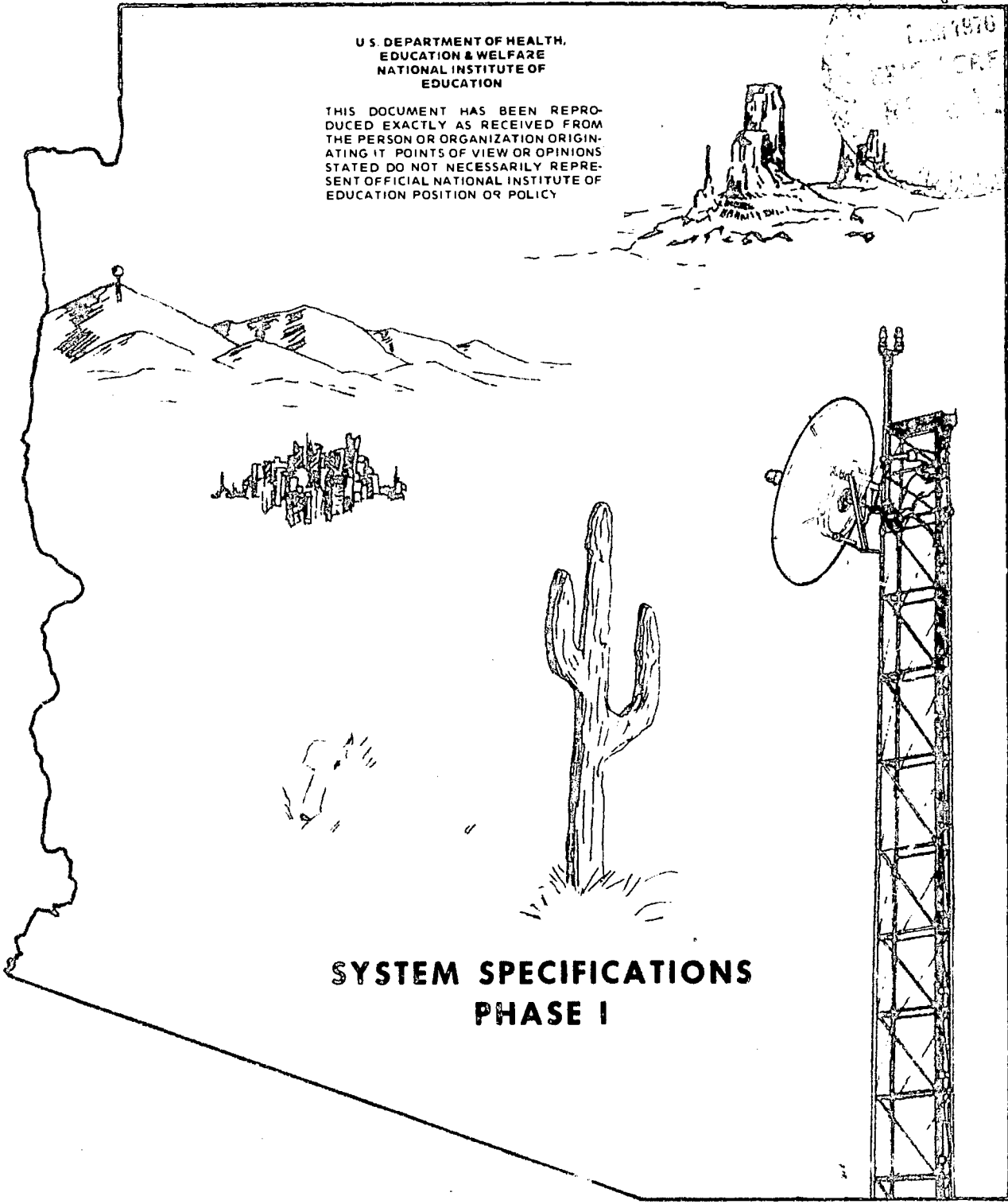
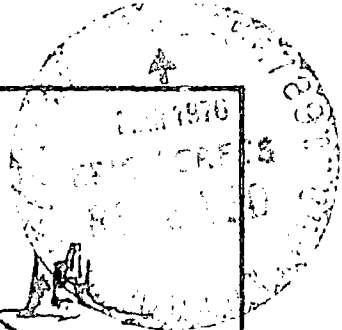

**SYSTEM SPECIFICATIONS  
PHASE I**

RC009024

**THE ARIZONA TELEMEDICINE NETWORK**

**SYSTEM PROCUREMENT SPECIFICATIONS, PHASE I**

**Prepared for:**

**The University of Arizona College of Medicine  
Department of Family and Community Medicine  
Tucson, Arizona 85724**

**Prepared by:**

**The Biomedical and Special Systems Group  
Telecommunications Department  
Atlantic Research Corporation  
Alexandria, Virginia 22314**

**December 31, 1972**

## TABLE OF CONTENTS

		Page
1.0	SCOPE . . . . .	1-1
1.1	System Description . . . . .	1-1
1.2	Area of Coverage . . . . .	1-1
1.3	Communications Medium . . . . .	1-2
1.4	Communications Channels . . . . .	1-2
1.5	Mobile Unit . . . . .	1-3
1.6	Switching . . . . .	1-4
1.7	Compatibility . . . . .	1-4
2.0	SYSTEM DESIGN . . . . .	2-1
2.1	Introduction . . . . .	2-1
2.2	Purpose of the Network . . . . .	2-1
2.3	Basic Design Objectives of the Network . . . . .	2-1
2.4	Geographic Scope of the Master Plan . . . . .	2-2
2.5	Information Handling Requirements . . . . .	2-3
2.6	Selection of Microwave Routes . . . . .	2-4
2.7	Signal Routing, Switching and System Management . . . . .	2-5
2.7.1	General . . . . .	2-5
2.7.2	Classification of Network Stations . . . . .	2-5
2.7.3	Referral Pattern . . . . .	2-6
2.7.4	Communication Service . . . . .	2-7
2.7.5	Communication Services, Class "a" Stations . . . . .	2-8
2.7.6	Communication Services, Class "b" Stations . . . . .	2-9
2.7.7	Communication Service, Class "c" Stations . . . . .	2-11
2.7.8	Control of Signal Routing . . . . .	2-12
2.7.9	Kitt Peak Switch Point (Class "R1" Station) . . . . .	2-13
2.7.10	San Xavier Switch Point (Class "R1" Station) . . . . .	2-15
2.7.11	Pinal Peak Switch Point (Class "R1" Station) . . . . .	2-16
2.7.12	Phoenix Switch Point (Class "c" Station) . . . . .	2-17
2.8	Control Console Equipment . . . . .	2-18
2.8.1	General . . . . .	2-18
2.8.2	Console Utilization . . . . .	2-18
2.8.3	Console Cable Connections . . . . .	2-21
2.8.4	Administrative Voice Channel Selection and Signaling Panels . . . . .	2-21
2.8.5	Switching Panels . . . . .	2-22
2.8.6	Elapsed Time Meters (not shown on drawings) . . . . .	2-22

## TABLE OF CONTENTS (Continued)

	Page
2.9 Communications Equipment Licensing . . . . .	2-22
2.10 Radio Frequency Channel Assignments . . . . .	2-23
 3.0 APPLICABLE DOCUMENTS . . . . .	 3-1
 4.0 TRANSMISSION PERFORMANCE REQUIREMENTS . . . . .	 4-1
4.1 Voice Bandwidth Channels . . . . .	4-1
4.2 Television Channels . . . . .	4-2
4.3 Telemetry Channel . . . . .	4-2
 5.0 EQUIPMENT PERFORMANCE REQUIREMENTS . . . . .	 5-1
5.1 Video Performance . . . . .	5-1
5.1.1 Color Standards . . . . .	5-1
5.1.2 Camera and Associated Equipment . . . . .	5-1
5.1.3 Television Monitors . . . . .	5-3
 5.2 Magnetic Tape Recorders and Playback Units . . . . .	 5-5
5.2.1 General . . . . .	5-5
5.2.2 Video Cassette Playback/Record Unit . . . . .	5-5
5.2.3 Audio Channel Logger . . . . .	5-6
 5.3 Switcher Matrices . . . . .	 5-7
5.3.1 General . . . . .	5-7
5.3.2 Video Switchers . . . . .	5-7
5.3.3 Audio Switchers . . . . .	5-7
 5.4 Video Amplifiers and Terminal Equipment . . . . .	 5-8
5.5 Audio Equipment . . . . .	5-9
5.6 Multiplex Channel Equipment . . . . .	5-9
5.7 Microwave Radio Equipment . . . . .	5-10
5.7.1 General . . . . .	5-10
5.7.2 Environmental Conditions . . . . .	5-10
5.7.3 Power Requirements . . . . .	5-10
5.7.4 Metered Parameters . . . . .	5-10

## TABLE OF CONTENTS (Continued)

	Page
5.7.5 Electrical Protection . . . . .	5-11
5.7.6 Mounting . . . . .	5-11
5.7.7 Modular Design . . . . .	5-12
5.7.8 Routine Adjustment . . . . .	5-12
5.7.9 Materials . . . . .	5-12
5.7.10 Component Requirements . . . . .	5-12
5.7.11 Marking and Finish Requirements . . . . .	5-12
5.7.12 Identification of Circuit Components . . . . .	5-13
 5.8 Teleprinter and Associated Equipment . . . . .	 5-13
5.8.1 General . . . . .	5-13
5.8.2 Information System Retrieval Terminal . . . . .	5-13
5.8.3 Modems . . . . .	5-13
 5.9 Facsimile Equipment . . . . .	 5-14
5.10 Slow-Scan Television Equipment . . . . .	5-14
5.11 Telemetry Channel Equipment . . . . .	5-15
5.11.1 FM Modulator . . . . .	5-15
5.11.2 Signal Conditioning for Transmission . . . . .	5-17
5.11.3 Calibration and Switching Unit for Transmission . . . . .	5-19
5.11.4 FM Demodulator . . . . .	5-19
5.11.5 Signal Conditioning for Reception . . . . .	5-23
5.11.6 Calibration and Switching for Reception . . . . .	5-24
 5.12 Wireless Headsets . . . . .	 5-25
5.13 Clinical Equipment . . . . .	5-25
5.13.1 Medical Equipment List – Major Items, Each of Two Sites (quantity of one unless specified otherwise) . . . . .	5-26
5.13.2 Personal Equipment . . . . .	5-27
5.13.3 Basic Furnishing . . . . .	5-27
5.13.4 Laboratory . . . . .	5-27
 6.0 MOBILE UNIT AND SUPPORT RELAY . . . . .	 6-1
6.1 General . . . . .	6-1
6.2 Mobile Layout and Objectives . . . . .	6-1
6.3 Vehicle Requirements . . . . .	6-1

## TABLE OF CONTENTS (Continued)

	Page
6.3.1 General . . . . .	6-1
6.3.2 Electrical System . . . . .	6-2
6.3.3 Lighting . . . . .	6-2
6.3.4 General Examination Room . . . . .	6-2
6.3.5 Interview Area . . . . .	6-3
6.3.6 X-ray Area . . . . .	6-3
6.3.7 Laboratory Area . . . . .	6-3
6.3.8 Lavatory . . . . .	6-3
6.3.9 Generator . . . . .	6-3
6.3.10 Air Conditioning/Interior Heating . . . . .	6-4
6.3.11 Supplementary Heating . . . . .	6-4
6.3.12 Hot Water Heater . . . . .	6-4
 6.4 Support Relay . . . . .	 6-4
6.4.1 General . . . . .	6-4
6.4.2 Relay Antenna and Support . . . . .	6-4
6.4.3 VHF Radio Link . . . . .	6-5
6.4.4 Relay Antenna Alignment . . . . .	6-5
6.4.5 Mobile Unit Antenna Alignment . . . . .	6-5
6.4.6 Positioning Tone Controls . . . . .	6-6
 7.0 OTHER TECHNICAL REQUIREMENTS . . . . .	 7-1
7.1 Cable Requirements . . . . .	7-1
7.2 Equipment Shelters, Appurtenances, Interface and Coordination . . . . .	7-2
7.2.1 General . . . . .	7-2
7.2.2 Mt. Lemmon . . . . .	7-2
7.2.3 Bylas . . . . .	7-2
7.2.4 Pinal Peak . . . . .	7-3
7.2.5 University of Arizona Medical Center at Tucson . . . . .	7-3
7.2.6 San Carlos . . . . .	7-4
7.2.7 Sells . . . . .	7-4
7.2.8 South Mountain . . . . .	7-4
7.2.9 Cimarron Peak . . . . .	7-4
7.2.10 Kitt Peak . . . . .	7-5
7.2.11 Pisinimo . . . . .	7-5
7.2.12 San Xavier . . . . .	7-5
7.2.13 Santa Rosa . . . . .	7-6

## TABLE OF CONTENTS (Continued)

	Page
7.2.14 Phoenix . . . . .	7-6
7.2.15 Prefabricated Shelters . . . . .	7-6
7.3 Towers, Antennas and Radomes . . . . .	7-7
7.3.1 Tower and Support Structures . . . . .	7-7
7.3.2 Test Boring . . . . .	7-8
7.3.3 Tower Lighting and Marking . . . . .	7-8
7.3.4 Removal of Old Tower and Relocation of Existing Antennas . . . . .	7-8
7.3.5 Microwave Antennas . . . . .	7-8
7.3.6 Radomes . . . . .	7-9
7.3.7 Reflectors . . . . .	7-9
7.3.8 Transmission Line . . . . .	7-9
7.3.9 Grounding . . . . .	7-9
7.4 Chain Link Fencing . . . . .	7-10
7.5 Equipment Failure Alarms . . . . .	7-11
7.6 Order Wire . . . . .	7-11
7.7 Frequency Shift Key Equipment . . . . .	7-12
7.8 Lighting . . . . .	7-12
7.9 System Maintenance Manual and Operation Manual . . . . .	7-12
7.10 Unit Instruction Manuals . . . . .	7-12
7.11 Test Equipment . . . . .	7-13
7.12 Spare Equipment and Materials Requirement . . . . .	7-14
7.13 Path Engineering . . . . .	7-15
7.14 Fade Margin . . . . .	7-15
7.15 Stand-by Electric Power . . . . .	7-15
7.15.1 General . . . . .	7-15
7.15.2 Generator Equipment Specifications . . . . .	7-16
7.16 Facilities, Equipment, Services to be Supplied by the Contractor . . . . .	7-17
8.0 QUALITY ASSURANCE . . . . .	8-1
8.1 Acceptance Test Plan . . . . .	8-1
8.2 Test Procedure and Schedule . . . . .	8-1
8.3 Tests at the Factory . . . . .	8-1
8.4 Preliminary Alignment and Test . . . . .	8-1
8.5 Site Inspection and Measurements . . . . .	8-2



**TABLE OF CONTENTS (Continued)**

		Page
9.0	GENERAL CONDITIONS AND INSTRUCTIONS TO CONTRACTOR . . . . .	9-1
9.1	Definitions . . . . .	9-1
9.2	Total System Responsibility . . . . .	9-1
9.3	Completeness of System . . . . .	9-3
9.4	Qualifications of Contractor and his Proposed Vendors . . . . .	9-3
9.5	Materials and Employees . . . . .	9-3
9.6	Superintendent, Supervision . . . . .	9-3
9.7	Preconstruction Submission of Drawings . . . . .	9-4
9.8	Subcontract (Consultants, Suppliers, etc.) . . . . .	9-5
9.9	Relations of Contractor and Subcontractor . . . . .	9-5
9.10	Changes in the Work . . . . .	9-5
9.11	Licenses, Permits, Taxes and Wages . . . . .	9-6
9.12	Property Damage . . . . .	9-6
9.13	Scheduling . . . . .	9-6
9.14	Final Cleanup . . . . .	9-6
9.15	Performance Bond . . . . .	9-6
9.16	Contract Schedule . . . . .	9-6
9.17	Workmen's Compensation and Liability Insurance . . . . .	9-7
9.18	Guarantee . . . . .	9-7
9.19	Prosecution of the Work . . . . .	9-8
9.20	Protection of Materials . . . . .	9-8
9.21	Workmanship . . . . .	9-8
9.22	Care of the Work . . . . .	9-8
9.23	Arbitration . . . . .	9-9
9.24	Testing . . . . .	9-9
9.25	Safety and Protection . . . . .	9-9
9.26	Completion and Acceptance . . . . .	9-9
9.27	Like Items of Same Manufacturer . . . . .	9-10
9.28	Experience . . . . .	9-10
9.29	Discrimination . . . . .	9-10
9.30	Environmental Protection . . . . .	9-10
9.31	Training . . . . .	9-10

APPENDIX A . . . PATH PROFILES

APPENDIX B . . . SITE MAPS

APPENDIX C . . . SITE PHOTOGRAPHS

APPENDIX D . . . DRAWINGS

## 1.0 SCOPE

### 1.1 System Description

This specification defines a complete communications facility; a mobile health communications treatment and diagnosis unit; clinical components such as X-ray, laboratory and examination equipment; and various related professional services.

### 1.2 Area of Coverage

The system treated in this document is defined as Phase I of the planned statewide system known as the Arizona TeleMedicine Network. Phase I covers the geographic area in the state of Arizona south of a hypothetical east-west line drawn through Phoenix. Refer to Figure B.1.<sup>1</sup> The terminal sites involved in Phase I are listed below. Photographs of most sites in the Phase I project are provided in Appendix C. Individual microwave station site maps are included as Figures B.2 through B.14.

- a. The University of Arizona Medical Center, Tucson
- b. The Health Program Systems Center, Indian Health Service, Tucson (Monitor point only)
- c. Sells Hospital, Sells
- d. Santa Rosa Clinic, Gu Achi
- e. Pisinimo (mobile health unit), Pisinimo
- f. San Carlos Hospital, San Carlos
- g. Bylas Clinic, Bylas
- h. Phoenix Indian Health Service Hospital, Phoenix.

In addition the following relay points are involved in Phase I:

---

<sup>1</sup>Throughout this document the alphabetical prefix refers to the location in the appendices, of the referenced item. Example: Figure B-1 is the first exhibit in Appendix B.

- a. South Mountain, KAET-TV, Phoenix
- b. Pinal Peak, near Globe, Arizona
- c. Cimarron Peak, northwest of Sells
- d. Kitt Peak, east of Sells
- e. Mt. Lemmon, near Tucson

### 1.3 Communications Medium

With the exception of the short cable link connecting the Health Program Systems Center (HPSC) monitor to the San Xavier relay station, all sites shall be interconnected using microwave radio. Full duplex microwave links are required in all cases.

Leased telephone company wireline circuits shall interconnect the San Xavier relay with the Bell Aerospace Computer currently used by the Indian Health Service's Health Information System (HIS).

### 1.4 Communications Channels

The full duplex microwave links shown in Figure B.1 shall be channelized to carry the following services.

- Full color television (525 line/30 frame with 5.5 MHz bandpass) – one channel
- Program Audio (15 kHz bandpass) – one channel
- Order wire (with selective signaling) – one channel
- "Voice" slots (FDM, 4 kHz spacing) – 12 channels<sup>1</sup>
- Alarm circuits – as specified

---

<sup>1</sup>Exact number actually provided depends on the position of the link in question as related to the terminal sites served.

A further breakdown of the use of the "voice" slots is included in the suggested spectrum utilization plans for each link (Figures D.1 through D.10).

The designated voice slots shown are to be used for the following services:

- Camera positioning control (tilt, pan, focus, zoom, iris, mono/color) – six channels (dc control) per voice slot
- Teleprinter/keyboard (300 baud) – six channels per voice slot, one channel per site
- Telemetry (IRIG Standard) dc to 500 Hz – one channel, single voice slot per site
- Slow-scan television (approximately one frame per two-minute interval) – one channel, single voice slot
- Switching control (relay sites, remote) – touch tones, share voice slot
- Administrative Voice Channel(s) – voice slots as required.

Locations in the network shall be provided with modems, FSK transmitter/receivers, FM telemetry devices and such required interface equipment so as to facilitate these services at each terminal site.

#### **1.5 Mobile Unit**

A completely equipped mobile shall be provided as a part of Phase I of the Arizona TeleMedicine Network. This unit shall include communications facilities to provide many of the services as provided at fixed clinics such as Santa Rosa and Bylas.

The mobile unit shall not be larger than 28 feet long by 8 feet wide and shall be a self-propelled type of vehicle. In addition to the basic clinic equipment, fixtures and furnishings, the unit shall carry minimal laboratory equipment and X-ray facilities. An on-board electric power generator shall be provided.

The basic control console, terminal equipment and communications originating facilities shall be contained within the mobile unit. From any point within a 21-mile radius it shall

be possible (line of sight permitting) to establish contact with the Pisinimo relay to provide full wideband interconnect service with the rest of the Arizona TeleMedicine Network.

#### **1.6 Switching**

Certain stations in the network shall have the capability of the control of route switching matrices located at various points throughout the network. Switching shall be independent for each of the following three services: color television (audio follow video); telemetry and slow-scan TV. No switching is required for the teleprinter service or for the dedicated voice channels (order wire and intercom or "Administrative Voice Channel").

#### **1.7 Compatibility**

All construction shall be fully consistent with the statewide plan as shown on Figure B.1. Such expansion possibilities shall be taken into account by the contractor in his work.

## **2.0 SYSTEM DESIGN**

### **2.1 Introduction**

This section of the specifications document will describe the plan of the major statewide network and the philosophy behind its conceptual design. The contractor shall regard the discussions concerning Phase I as an integral part of the system procurement specifications.

### **2.2 Purpose of the Network**

The purpose of the medical communication network is to alleviate the barriers and expand the availability of effective delivery of health services. These barriers are the ancient ones of time, geography and weather which tend to disrupt communication between health service providers involved in training clinical support and delivery of health services and the recipient of health services. These professional contacts and support relationships are the actual core of the health services system. The proposed communication network permits these barriers to be circumvented, provides a system of professional support between physicians, community hospitals, metropolitan medical centers and the Community Health Medics.

The need to improve the delivery of health service to remote Indian reservations is great. The Indian population is currently served by the Indian Health Service which maintains medical field stations, area and peripheral hospitals to accomplish its mission. Chronic shortages of health care personnel in remote areas combined with the logistical problems associated with serving a large low density population has hampered the achievement of optimal health care.

The personnel shortage is alleviated somewhat by the increasing availability of Community Health Medics (CHMs), Indian men and women with backgrounds in the health field, who are qualified under medical supervision to deliver primary health services in independent or semi-independent situations on the reservations. This communication network will bring the resources of the medical center to support and maintain the CHM at a high professional level and will help to further expand, improve and integrate the efforts of the Indian Health Service.

### **2.3 Basic Design Objectives of the Network**

The basic design objectives of the communications network are:

- o to link or be available to 100 percent of the designated population groups

- ⊙ to enhance care in the home locale of the patient and family insofar as practical (and consistent with quality treatment)
- ⊙ to expedite specialized primary health care delivery and where practical to deliver care for those individuals requiring secondary and tertiary care beyond the present scope of primary service system
- ⊙ to be patient acceptable and in harmony with his personal customs and concern for privacy
- ⊙ to be user acceptable and in harmony with legal requirements and the skills of the professional health care providers
- ⊙ to be responsive in terms of cost and task effectiveness to the associated or anticipated activities of the sponsor
- ⊙ to be accessible both in terms of 24 hours a day time access and geographic flexibility
- to be reliable and fail safe
- to be easily operable by health service personnel.

#### 2.4 Geographic Scope of the Master Plan

The proposed health communication system will eventually link the five indian reservations in Arizona. These reservations are:

- a. Papago
- b. San Carlos Apache
- c. White Mountain Apache
- d. Navajo
- e. Hopi

In collaboration with the Indian Health Service and tribal representatives, field health stations, area and peripheral hospitals will be linked by a communications network. In addition to facilities in remote areas, urban medical centers representing the most advanced medical techniques will be part of the network. These centers are the Phoenix Indian Medical Center (PIMC), the University of Arizona Medical Center (UAMC), and at a later date will include St. Joseph's and Good Samaritan hospitals. When fully established, the network will integrate the above mentioned health service facilities and be capable of providing the Indian population with comprehensive, high quality health care. Ultimately an expansion of this network will provide improvements in health services to other rural or isolated regions characterized by chronic shortages of health personnel.

Figure B.1 displays the sites involved in the statewide plan, with the exception of St. Joseph's Hospital and Good Samaritan Hospital which may be linked by other than microwave.

The terminal sites involved in the Phase I project covered by these specifications are in the following locations: Phoenix, Pisinimo, Santa Rosa (Gu Achi), Sells, Tucson, San Carlos and Bylas.

## 2.5 Information Handling Requirements

The following types of information will be required for transfer over the Arizona TeleMedicine Network.

<u>Types of Data</u>	<u>Communications Mode</u>
Input/output terminals for computer systems	Narrowband – digital data circuits
Voice	Narrowband – telephone grade circuits
Physiological signals such as respiratory rates and volumes, electrocardiographic signals, heart sounds, voice or other high quality audio data with a high content of low frequency information	FM telemetry – within a voice grade channel
System supervisory voice and signaling	Narrowband – telephone grade intercom circuits
Photographs, charts, X-rays, visual examination of subjects, prescription orders, hand or typewritten material, diagnostic/	Narrowband – facsimile and/or slow-scan TV



therapeutic sketches, strip chart tracings  
(ECG, PCG, etc.)

Live (real time) visual examinations of subjects  
in color, interactive, video educational material

Wideband – video grade duplex  
TV transmission circuits

Live (real time) visual examination of subjects  
in black and white, interactive, video  
educational material

Wideband – video grade duplex  
TV transmission circuits

## 2.6 Selection of Microwave Routes

The selection of relay points and microwave routes to be used throughout the Arizona TeleMedicine Network was based upon the need to provide the most efficient point-to-point paths.<sup>1</sup> Route selection was also influenced by the desire to share existing facilities wherever possible. In this regard, a survey was undertaken to determine the location of major communication system users in the state of Arizona. Where it was found that presently developed sites could be effectively utilized, arrangements were sought for joint use.

In particular, for the Phase I project, the following developed relay sites were selected:

**Kitt Peak** This site which is located on Papago Indian Land is used as an astronomical observatory and is administered by Kitt Peak National Observatory, 950 N. Cherry Avenue, Tucson, Arizona. The Kitt Peak site provides hard surface roadway access, commercial ac power and stand-by power. An installation charge and yearly use fee will be imposed.

**Mt. Lemmon** This site is currently used by many communications firms and the Federal Government for radio relay purposes. Several firms provide equipment space and towers on a rental basis. The proposed Arizona TeleMedicine Network relay will be housed in the existing building owned by General Communications of Tucson. A rental fee will be charged. Hard surface roadway access is available as well as both commercial power and stand-by power.

---

<sup>1</sup>Path profiles are provided in Appendix A. Contractor shall verify all path profiles prior to construction.

Pinal Peak Again, this site is already heavily used as a radio relay by many different users. The Arizona TeleMedicine Network will share the existing building owned by the San Carlos Bureau of Indian Affairs. Hard surface roadway and commercial power are available.

## 2.7 Signal Routing, Switching and System Management

### 2.7.1 General

In selection the switching plan for signal routing, control and network management, several factors were taken into account. The switching plan must be compatible with the existing referral pattern; it must be reasonably simple from the operator's standpoint; and it must reflect in its technical design the need and desire for localized control. In specifying "localized control," the intent is to avoid a network where all communications are channeled through or solely under the control of a single centralized agency. Naturally, the switching plan must, without compromising effectiveness, be optimized for economy and use of the limited radio spectrum.

### 2.7.2 Classification of Network Stations

The relay and terminal sites of the Arizona Health Network for the purpose of definition will be classified into the following groups:

- Class "a": Field health stations
- Class "b": First level referral centers (peripheral hospitals)
- Class "c": Second level referral centers (major medical centers)
- Class "R1": Switching relays
- Class "R2": Repeater relays

By definition, field health stations (class "a" stations) shall be the "front line" with the least concentration of specialized skills. Within this classification are the facilities at Bylas, Santa Rosa and Pisinimo. Pisinimo is, however, a special case in that the facility there will be a mobile health communications unit working into a relay station.

First level referral centers (class "b" stations) are those medical facilities that normally could be expected to provide backup support directly to the field health stations. As is currently the case with physical referral, the first level referral centers would accept, via the telemedicine network, cases deemed beyond the scope of the field health stations to handle. In Phase I, Sells and San Carlos are the class "b" stations.

Class "c" stations, as a group, will consist of all other terminal sites in the network. These sites are defined as the major medical centers in the health care system to which cases are referred that cannot be effectively handled at either the field health stations or the first level referral centers. The medical centers at Phoenix and Tucson are class "c" stations.

The switching relays, class "R1" stations, are radio relay stations that serve as intermediate stations for the transfer of signals between three or more stations of any type. Control of the route switching equipment at the switching relays would rest with the nearest associated class "b" or class "c" station. Pinal Peak, San Xavier, and Kitt Peak are class "R1" stations.

Class "R2" stations, repeater relays are defined as those stations that provide full duplex interconnect facilities between two other stations of any type. Cimarron Peak, Mt. Lemmon and South Mountain are class "R2" stations.

Not classified in the above groups is a television monitor (simplex, remotely switched) at the Health Program Systems Center (HPSC) located adjacent to the San Xavier switching relay site.

### 2.7.3 Referral Pattern

The following referral pattern was used in assigning switching control responsibilities:

<u>Class "a"</u>	<u>Class "b"</u>	<u>Class "c"</u>
Pisinimo	} to Sells	to Phoenix (Tucson as alternate)
Santa Rosa		
Bylas	to San Carlos	to Phoenix

#### 2.7.4 Communication Service

Between class "a" stations and class "b" stations, the following communication services shall be provided.

<u>Description</u>	<u>Requirement</u>	<u>Bandpass</u>	<u>Switching</u>
Administrative (coordination) voice channel	1 – duplex	300 to 3,000 Hz	None, dedicated channel
Video channel <sup>1</sup> (525 line/30 frames)	1 – duplex	0 to 5.5 MHz	Controlled by class b/c
Program voice channel (associated with video)	1 – duplex	30 to 15,000 Hz	Follows video
Facsimile (slow-scan) channel	1 – duplex	300 to 3,500 Hz	Controlled by class b/c
Teleprinter channel <sup>2</sup>	1 – duplex	300 baud	None, dedicated channel
Telemetry channel <sup>3</sup>	1 – duplex	0 to 500 Hz	Controlled by class b/c
Camera control tones	6 – duplex	50 Hz each	Follows video
Signaling tones	duplex single frequency tones	share administrative voice channel	Locally generated

<sup>1</sup> SECAM 60 color encoding with subcarrier at 4.43 MHz.

<sup>2</sup> Teleprinter/keyboard service is always "on line" with the computer center.

<sup>3</sup> Local switching or patching shall determine which type of physiological data is to be transmitted. Selection will be one of three possibilities: electrocardiogram (ECG); lung function signals (spirogram); or electronic stethoscope (heart sounds, etc.).

Between class "b" and class "c" stations the same communication services shall be provided as listed above. Switching control will rest with the class "c" stations in this case. The normal referral pattern shall hold in that the class "c" station(s) ultimately used by various class "a" stations shall be capable of switching referrals through from that level as well as from the class "b" level.

#### **2.7.5 Communication Services, Class "a" Stations**

At each of the local field health stations, the following services, abstracted from the previous list, shall be available. Switching for appropriate routing, where required, is indicated.

##### **Administrative Voice Channel (AdVC)**

Each class "a" station field health stations shall have a dedicated private line voice circuit to its associated class "b" station. Signaling (ringing) will be possible from either end by the use of push button control of tones. Contractor shall provide parallel light and alarm where indicated in the site and floor plan drawings.<sup>1</sup> This channel will be used by the field health stations to contact the peripheral hospitals for such purposes as to solicit information (voice consultation) and to set up other levels of communication links. Conferencing by push button control shall be possible at each class "b" station for all Administrative Voice Channels terminating therein. At each station where an existing VHF radio system is available, a patchcord arrangement will be provided between the radio system and the AdVC panel.

##### **Video Channel**

Should a class "a" station desire to consult in this mode with its associated class "b" station, this need would be communicated to the class "b" station by the class "a" station using the Administrative Voice Channel. Should the signal path be available at that time, the class "b" station will actuate the appropriate remote switches to set up a duplex link.

##### **Program Voice Channel**

This channel of high quality sound is associated with the video channel. This high quality voice channel is switched concurrently with the video channel to automatically parallel the route of the video.

---

<sup>1</sup> Figures D.11 through D.25

### **Camera Control Tones**

These control tones are used for positioning the cameras from distant locations. For example, the camera at Santa Rosa field health station shall be capable of being controlled by an operator (or a physician) located at Sells. Camera functions controlled would include tilt, pan, focus, zoom and iris. In all, six functions will be possible for simultaneous remote control. The sixth tone shall actuate a monochrome bypass switch in the color camera chain. These tones shall be switched en masse and concurrently with the video to parallel that route.

### **Slow Scan TV/Facsimile Channel**

Should a class "a" station desire to exchange "hard copy" diagrams, charts or printed matter with its associated class "b" peripheral hospital, the Administrative Voice Channel will be used to arrange for it. Again, the class "b" station will remotely actuate the required switches. This service is switched independently of any other communication level. All stations shall be provided with a slow-scan television send and receive device. Santa Rosa, Sells and Tucson shall also be provided with a business facsimile transceiver.

### **Teleprinter Channel**

This channel does not require switching. Each station shall have a dedicated circuit back to the central computer in Tucson.

### **Telemetry Channel/Electronic Stethoscope Channel**

Requests for routing of this channel shall be made by the class "a" stations over the Administrative Voice Channels. Control of the actual switching shall rest with the appropriate class "b" station and shall be independent of other services.

### **2.7.6 Communication Services, Class "b" Stations**

The following services shall be provided at each peripheral hospital (class "b" station) in the Phase I network.

#### **Administrative Voice Channels (AdVC)**

As mentioned earlier, this channel is, in the case of each class "a" station, a dedicated line back to its associated class "b" station. Each line termination must be available for

access at the class "b" station. Likewise, at the class "b" station, signaling tones shall be applied to each line, individually, for the purpose of "ringing" each class "a" station. These same circuits shall be used by the class "b" station to transmit the necessary touch-tone signals used for control of remote switches.

An additional Administrative Voice Channel (or two in the cases where optional class "c" stations exist) will be used for direct communication with the associated class "c" station. Again, this dedicated circuit will be used for voice consultation and switching coordination in the routing of signals to the "c" level.

Remote lights and audible alarms are required to parallel the local console alarm at some sites. Refer to the drawings (Figures D.11 through D.25).

Conferencing shall be possible between all circuits terminating at the class "b" stations and shall be controlled by push buttons on the AdVC panel.

In the course of seeking a voice level consultation, a remote station may not find the appropriate specialist to be in the immediate vicinity of the telemedicine room. Therefore, the referral centers' (class "b" and "c" stations) console operators shall be provided with means whereby incoming and outgoing Administrative Voice Channel service can be extended via the local PABX (Private Automatic Business Exchange). The extension of the AdVC Service should not be limited to the confines dictated by the local PABX telephone system.

In a like manner, means should be provided for the extension of AdVC service over existing VHF radio systems. For this extension, a simple four-wire patchcord arrangement will suffice. Since a console operator will be present during those times when the VHF extension service is needed, the push-to-talk operation of the VHF radio may be retained.

### **Video Channel**

The appropriate switching where necessary to route a desired class "a" station video signal into the associated class "b" station is done remotely. Sells, a class "b" station, shall be equipped to control this switching through the use of touch-tone codes sent out over an Administrative Voice Channel. When Phoenix is not interacting with either San Carlos or Bylas, the switches normally connecting San Carlos with Bylas are closed. San Carlos, therefore, does not require switching control (routing) facilities.

Should it be desired by the class "b" to refer one of its class "a" inquiries on to the associated class "c" station, it shall be capable of requesting such a configuration by contacting the class "c" station on the AdVC. Switching of the video in these cases shall be controlled by the class "c" station(s).

#### **Program Voice Channel/Camera Control Tones**

Both of these services are switched concurrently with and parallel to the video, discussed above.

#### **Slow-Scan TV/Facsimile Channel**

Routing of these channels is independent of any other service, however, coordination and switching control is analogous to the video plan described above.

#### **Teleprinter Channel**

Each class "b" network station will have a dedicated duplex teleprinter circuit provided.

All teleprinter circuits will have as their final destination, the HIS computer service at Tucson. A leased telephone line (or lines) will interconnect the microwave terminal at San Xavier with the computer facility.

#### **Telemetry Channel/Electronic Stethoscope Channel**

Again, control and coordination is similar to that provided for video route switching. Routing is independent of all other services.

### **2.7.7 Communication Services, Class "c" Stations**

The class "c" stations are the sites having the greatest concentration of specialized skills in the Arizona TeleMedicine Network. Class "c" stations may directly communicate with other class "c" and their associated class "b" stations. Class "c" stations may also communicate indirectly with all other class "b" and class "a" stations by requesting the appropriate route switching that may be needed but is not controlled by the class "c" station in question.



From the standpoint of a typical class "c" station (major medical center), the levels of service and switching availabilities are as follows:

#### **Administrative Voice Channel**

Class "c" stations will have the capability of selecting one from the several dedicated voice circuits available at each site. These circuits will provide for direct communication to each of the other class "c" stations in the network, to the class "b" stations associated with the class "c" in question, and those class "a" stations which report directly to the class "c" station. The method of extending the AdVC discussed in Section 2.7.6 via telephone and radio (where available) shall be provided at each class "c" station.

The administrative voice channels will also carry the necessary switching tones generated by the class "c" station in conjunction with the control of those remote switching points under the station's jurisdiction.

#### **Video Channel – Program Voice Channel – Camera Control Tones**

These three related services are, as in the arrangement for class "a" and class "b" stations, switched in tandem.

#### **Slow-Scan TV/Facsimile Channel**

This service is switched independently of all other services.

#### **Teleprinter Channel**

This service is not switched and is always available to all classes of stations.

#### **Telemetry Channel/Electronic Stethoscope Channel**

This service is, as with all classes of stations, switched independent of any other communication service.

### **2.7.8 Control of Signal Routing**

In Phase I of the Arizona TeleMedicine Network, the following control and switching relationships shall prevail:

<u>Switching Relay</u>	<u>Control Station(s)</u>
Kitt Peak	Phoenix (class "c") Sells (class "b") Tucson (class "c")
Pinal Peak	Phoenix
San Xavier	Tucson

In addition to the above, Phoenix will control the switching at its own site where signals are received from two directions (three, counting the Phoenix originated signals).

#### 2.7.9 Kitt Peak Switch Point (Class "R1" Station)

##### General

At this remote relay and switching point there are transmitter/receiver pairs linking Kitt Peak with five other microwave sites. These T/R pairs are designated as follows:

- Cimarron: This T/R pair links, ultimately, with the Phoenix Indian Medical Center
- San Xavier: This T/R pair links with the San Xavier switch point for additional routing
- Sells: This T/R pair is a direct link to and from the Sells Hospital terminal site
- Pisinimo: This T/R pair links directly to the Pisinimo mobile relay facility
- Santa Rosa: This T/R pair links directly with the Santa Rosa field health station

Control of the switching circuits rests with three sites: Sells, the class "b" station; Phoenix, a class "c" station; and Tucson, an optional class "c" station. Switching commands arrive at the Kitt Peak station via the Administrative Voice Channels<sup>1</sup> listed below:

<sup>1</sup>Note that the Administrative Voice Channels (AdVC) are to be four wire circuits – no hybrids are used. In this way, a conference call on the AdVC will still not allow tones generated by other than the authorized stations to cause switching to occur.

Phoenix originated control tones:       via the Phoenix to Sells dedicated channel  
Tucson originated control tones:       via the Tucson to Sells dedicated channel  
Sells originated control tones:       via the Sells to Santa Rosa dedicated channel.

It should be noted, again, that switching is on three distinct levels. That is, video routing is controlled independently of telemetry. Likewise, slow-scan TV is controlled independently. Separate tones are required as well as separate switching relays and/or matrices.

### **Kitt Peak Switching Combinations**

The various switching combinations for the Kitt Peak switch are graphically described in Figure D.26. This figure actually represents a multiple pole relay but will be termed a "matrix" throughout this discussion.

Arranged along the outside of the matrix are the inputs and outputs to it. Within the squares are the names of the stations having control over those particular switching positions. Privacy of communication is assured in all cases since stations of a lower classification cannot access certain switch configurations.

Before any class "b" or "c" station attempts to switch its outgoing signals to another of the sites listed on the right-hand side of the diagram, he will, as a standard practice, switch that link's incoming circuit back to himself in order to verify that no connection is already in progress. For example, consider the case where Phoenix wishes to "call" Tucson but where Sells is already in communication with San Xavier. In this case, the San Xavier to Kitt Peak and the Kitt Peak to San Xavier link is in use. For this reason it should be firmly established as network policy that, unless an emergency exists, a station attempting to establish a link with another (Phoenix, in the example) should switch its receive link first. Furthermore, the initiating station should start with its switch commands with the nearest relay point (Kitt Peak in this case). In the example, Phoenix should depress its San Xavier to Cimarron push button and view the screen. If no signal is present, Phoenix may continue its receiver switching at the next relay site (San Xavier). Switching at San Xavier will be done upon request from Phoenix by the station at the University of Arizona Medical Center, Tucson.

The reset codes generated by each control station (Tucson, Phoenix or Sells) are established to release specific matrix points from contact following a program segment on the network. Each control station has a specific single reset tone code assigned to it for each switch point and each service. The matrix points affected by the individual tones (one from each station) are shown on the matrix diagram of the Kitt Peak switch.

It should be noted that the switch points in each horizontal row are interlocked so that only one signal may be applied to any one transmitter at any one time.

### **Control Panels Associated with Kitt Peak**

The control panel layouts for Selis, Phoenix and Tucson are shown in Figures D.27, D.28 and D.29.

#### **2.7.10 San Xavier Switch Point (Class "R1" Station)**

##### **General**

The San Xavier Switch Point, located near the Health Program Services Center, serves as the remote relay and switching point for three microwave links. In addition, this site is to be linked by one way cable to the north conference room in the main building at HPSC. This "monitor wire" may be connected, via the microwave system, to any site within the Arizona TeleMedicine Network. Switching of this video link as well as the other components of the matrices located at San Xavier is controlled by the Arizona Medical Center in Tucson. The HPSC monitor link will be treated separately following a discussion of the duplex switching requirement at San Xavier.

The various transmit/receive (T/R) pairs handled by the San Xavier switch are as follows:

**Kitt Peak:** This T/R pair links the San Xavier switch point with the Kitt Peak site where further switching may take place

**Mt. Lemmon/  
Pinal Pk:** This T/R pair links San Xavier with the class "R2" relay on Mt. Lemmon where it is ultimately linked with Pinal Peak. No switching takes place on Mt. Lemmon. Pinal Peak is the next switch point in the network.

**Tucson:** This T/R pair links the San Xavier switch point with the Arizona Medical Center in Tucson.

Control of the switching circuits at San Xavier, as already stated, will rest with the University of Arizona Medical Center. Switching commands (tones) will reach the switching unit via the Tucson to Phoenix Administrative Voice Channel.

## San Xavier Switching Combinations

Separate tones and switching matrices will be required for each communication service provided (video, telemetry and slow-scan television). The various combinations for each matrix are graphically displayed as Figure D.30.

### Control Panels Associated with San Xavier

Figure D.31 shows the switching panel layout for control of the San Xavier switch by the Arizona Medical Center, Tucson.

### Control of the HPSC Monitor Link

Control of the input television signal to the HPSC monitor cable will rest with Tucson and will involve selecting, on a remote basis, one of four possible inputs (audio and video) to the monitor wire. These four possibilities are: Tucson, Kitt Peak, Mt. Lemmon, and an open circuit.

The control panel for this function is shown in Figure D.32.

## 2.7.11 Pinal Peak Switch Point (Class "R1" Station)

### General

At this site five transmitter/receiver (T/R) pairs are brought together for switching. They are listed below:

Phoenix: This T/R pair links the Phoenix Indian Medical Center with the Pinal Peak switching center.

Mt. Lemmon: This pair provides a route south.

Mormon Tank:<sup>1</sup> This pair links the Mormon Tank switching center into the hub at Pinal Peak.

<sup>1</sup>Radio equipment and associated units for the Mormon Tank link will not be installed as part of the Phase I project. Control and switching circuits shall be installed as part of the Phase I project to permit easy addition of this link at a later time.

**San Carlos:** The T/R pair for the Indian Health Service Hospital at San Carlos.

**Bylas:** The link to Bylas Clinic.

In remote command of various switch configurations at Pinal Peak is Phoenix, a class "c" station.

The control tones, originated by Phoenix used to actuate the Pinal Peak switching equipment, are carried via the Phoenix to San Carlos dedicated channel.

### **Pinal Peak Switching Combinations**

The various switch configurations possible at Pinal Peak are illustrated in Figure D.33.

### **Control Panel Associated with Pinal Peak**

A drawing of the video control panel at Phoenix is shown as Figure D.34. The drawing presented in this section, as in the previous sections, is for video switching only. In reality similar matrices will be provided for each of the other distinct communications services delivered over the network system.

## **2.7.12 Phoenix Switch Point (Class "c" Station)**

### **General**

Three transmit/receiver (T/R) microwave pairs come together at the Phoenix Indian Medical Center terminal site. In addition to these remote links, one must consider the signals generated and received by Phoenix itself as a fourth T/R pair. Furthermore, it can be projected that expansions both within and outside of the Phoenix Indian Medical Center will create additional inputs that should be considered at this time in setting requirements.

The initial T/R pairs may be identified as described on the list below:

**Pinal:** This T/R pair serves as the link to all eastern stations and as the prime link with Tucson

**Kitt Peak:** This southern T/R pair, relayed without switching through South Mountain and Cimarron Peak, is the prime link with Sells and its associated stations

**Mt. Elden:**<sup>1</sup> This T/R pair is the route north and is relayed without switching through Shaw Butte and Mingus. Additional switching takes place at Mt. Elden and beyond for ultimate interconnection with stations on the Hopi Reservation and in the Navajo Nation

**Phoenix:** The Phoenix designation for this pair signifies the link to the first of what may grow to a large number of specialists' telediagnosis rooms located throughout the hospital or, at least, on its grounds

### **Matrix and Control Panel**

Shown as Figure D.35 is a representation of both the matrix and its control panel.

## **2.8 Control Console Equipment**

### **2.8.1 General**

The control console for each terminal station in the Arizona TeleMedicine Network is indicated in each floor plan layout. This unit will serve as the operator's desk and will provide additional rack space for the modulating, demodulating and signaling equipment. Figure D.36 is an artist's sketch of a typical control console as would be encountered at a class "b" station. The top view of this typical console is shown as Figure D.37.

While each station will involve some "customizing" of this design, the basic features and panel configurations will not change. The following sections of this document define the aspects of the console that are common to all sites and, also, define the differences in panels and arrangements existing between each individual site. Contractor is cautioned to recognize the size constraint of the 60- by 30-inch console.

### **2.8.2 Console Utilization**

Listed below are the functions and panel space allocations associated with the control consoles. Those items which involve custom changes from site to site are indicated and noted where appropriate. For additional clarification of panel locations, refer to Figures D.36 and D.37. Also, see Figure D.46 which is a functional block diagram of a typical network station.

**Twin 9-Inch Monochrome Monitors** – located top, center.

**Monitor Feed Select Push Buttons** – located top, center near monitors. These buttons select the feed for the twin 9-inch monitors and the associated room size monitors which parallel them.

**Audio Monitor Level Control and Speaker** – located on upper, right panel. This unit provides program audio as it arrives with the desired incoming picture. Additionally, a switch will permit selection of outgoing programs or video tape sound. Use of the headset shall automatically defeat the loud speaker.

**Handset (Administrative Voice Channel)** – located on right side of desk top, connector in knee hole of desk. Extra long coil cord (15 feet) required.

**Audio Channel Select and Signaling Buttons, AdVC** – located on right side of the sloping control board, upper right panel. The precise configuration of the push buttons on this panel will vary depending on the site involved. In all cases the audio channel select, telephone interconnect, and signaling positions will consist of 1- by 1-inch illuminated buttons. The top button in each position will flash (and a common audible alarm will sound)<sup>1</sup> when a “ringing” signal is received via the associated Administrative Voice Channel (AdVC). The flashing light and tone will continue until this button is depressed and the handset is connected. The middle button in each vertical row is used to signal the station associated with that particular AdVC. Signal tones are generated only as long as the button is depressed. At stations where more than one position appears on the AdVC panel (class “b” or “c” stations), the upper button may be depressed twice to achieve a “conference configuration” with all stations appearing on the panel. Disconnect is effected by depressing the button still a third time. The bottom button will effect cross connect with the telephone line provided at each “b” and “c” station.

**Recorder Remote Control Panels** – located top, center. These panels are not required for those consoles installed at class “a” stations. In each case, controls consist of “record,” “play,” “fast forward,” “rewind,” and “stop.” Status lights shall be provided for each panel to indicate “record on” and “record off.”

---

<sup>1</sup>This alarm, an intermittent electronic tone and flashing light, will be paralleled for remote indications as needed at Phoenix, San Carlos, and Sells.



**Audio Mixer Panel** – located top, center of the console, beneath a hinged panel. This mixer shall provide a minimum of three simultaneous low level (microphone) inputs and one high level (video tape audio) input plus switched input capacity (high level) of an additional four channels (audio logger).

**Recorders (one four-track audio and one single-track television recorder)** – located in lower, right rack at the rear of the console. Recorders are only to be installed at class “c” and class “b” stations.

**Telemetry Display** – this unit is to be located on the sloped panel, right upper portion of the console. Only class “b” and “c” stations will incorporate this unit which provides a real-time meter face readout for lung function tests or other information being viewed.

**Camera Joy Stick and Local/Remote Switch** – located top, center. In addition to the joy stick which controls tilt and pan, switches are to be provided for zoom, focus, iris and mono/color. The mono/color switch will control bypass circuitry in the color camera (local or remote) such that a direct monochrome video feed may be shunted to the camera output. This bypass circuitry should involve only the “green gun” of the camera, prior to bandpass shaping, electronic filtering or matrixing. Resolution shall exceed 600 television lines when the bypass is activated.

When the local/remote switch on the control panel is in the remote position, the panel controls will be disengaged from the local servo motors. These motors will then respond to control tones arriving via the microwave system. Simultaneously, the panel controls will be so connected as to produce tones on the outgoing microwave channel for control of a remote camera.

**Electronic Stethoscope Headset** – to be hung on the right side of the desk top. This headset may be either used for its prime purpose or connected, via the patch panel, to the program channel for private listening. (See earlier discussion on audio monitor level control and speaker).

**Microphone Connectors** – to be located at the upper rear of the console knee hole in a recessed panel. In addition to the fixed console microphone there will be provided two lavalier microphones available for use at each site.

**Switching Panel** – located for most class “b” stations on the left-hand, sloping panel on top of the console. This panel, whether located on the console or adjacent to it, controls the local and remote switching for television, slow-scan TV, and telemetry. This panel is blank for class “a” stations.

**Circuit Breakers** – located on the upper, left panel. These breakers, each of an appropriate value, will act as power switches to control various sections of the console apparatus. Individual breakers will be associated with the following: studio lights, monitors, camera, teleprinter, facsimile/slow-scan, and all other units in aggregate. A master breaker will also be supplied.

**Camera Control** – located at lower left of console. This unit is used for “technical setup of the camera” (optional, depending on type of camera used).

**Rack Mounted Equipment** – at class “b” and class “c” stations the front lower sections of the console are allocated to rack equipment. Class “a” stations utilize the rear, lower right area for rack equipment since recorders are not planned for these stations.

**Audio Jack Panel** – located on the upper right panel, adjacent to the program channel loud speaker. Input/output high level positions will be provided for: telemetry channel, program audio, electronic stethoscope and one spare. The facsimile channel may be used as an auxiliary voice return in lecture programming (a grand round).

### 2.8.3 Console Cable Connections

The console shall not be permanently positioned within each room. This requirement is set forth in order to permit maintenance to be accomplished without the need to dismount many units for access to those sections located interior to the console. For this reason, telemetry, slow-scan TV, power cables, coaxial cable, and other signal wires are to connect to the console by way of flexible sections and multiple pin connectors.

### 2.8.4 Administrative Voice Channel Selection and Signaling Panels

Figures D.38 through D.42 display the configurations of the AdVC panels at each station in Phase I of the Arizona TeleMedicine Network.

All push buttons shall be 1 inch by 1 inch (nominal), rear illuminated, and marked as indicated.

### **2.8.5 Switching Panels**

Figures D.43, D.44 and D.45 describe the required configurations of the television, telemetry and slow-scan TV switching control panels located at each station in Phase I of the Arizona TeleMedicine Network. It is to be noted that no switching control panels are required at class "a" stations (Bylas, Pisinimo, Santa Rosa) or at San Carlos.

### **2.8.6 Elapsed Time Meters (not shown on drawings)**

At all classes of terminal stations, a separate digital readout meter shall be provided for color TV, monochrome TV, slow-scan TV, Telemetry and Administrative Voice Channel. These meters shall record the accumulated usage of each service mentioned in hours and minutes. The meters shall have a range of at least 1000 hours and be resettable.

### **2.9 Communications Equipment Licensing**

Licensing of the microwave radio stations in the Arizona TeleMedicine System shall be in accordance with Part 91 of the Rules and Regulations of the Federal Communications Commission (FCC). Part 91 covers that part of the rules dealing with the "Business Radio Service." The licensee shall be the Board of Regents of the State of Arizona.

Preparation and filing of all radio license applications shall be the responsibility of the Contractor. The Contractor shall also provide such legal assistance in this matter as is required to obtain all necessary licenses and construction permits short of legal assistance in hearings and trials. The Contractor's attorney shall be a member of the bar in the District of Columbia; shall have at least two years of experience in communications law; and shall have participated in proceedings before the Federal Communications Commission prior to any such actions for the Arizona TeleMedicine Network.

It shall be the responsibility of the Contractor to secure two adjacent 10 MHz channels for each link in the Arizona TeleMedicine Network that demands allocation in the 6525 to 6875 MHz band. This will be the case for all links involving a path length of greater than 22 miles. Since the network will require at least 20 MHz of RF bandwidth for each link, and since the 6525 to 6875 MHz band is limited to 10 MHz channel spacing, the double channel format shall be used.

All other links shall be licensed in the 12,200 to 12,700 MHz band.

## 2.10 Radio Frequency Channel Assignments

It shall be the responsibility of the Contractor to conduct a careful search for frequencies to be used in the Arizona TeleMedicine Network. From this search, the Contractor shall develop a frequency plan which shall be submitted to the Project Director for his approval prior to the preparation and submission of license applications to the Federal Communications Commission.

The Contractor's microwave frequency plan shall be in accordance with FCC Rules and Regulations, shall take into account the network's 20 MHz RF bandwidth requirement and shall be compatible with all other microwave systems operating on the same or adjacent frequencies.

The frequency plan<sup>1</sup> presented as Table 2-1 is set forth purely as information to the Contractor. The Contractor's own frequency plan does not necessarily have to agree with this plan. The Contractor is cautioned to make his own independent frequency search in order to ascertain availabilities and, from this data, to develop his own frequency plan.

The Arizona TeleMedicine Network and the University of Arizona shall accept no responsibility for difficulties or extra costs incurred by the Contractor as a result of his use of this data.

---

<sup>1</sup>VHF plan not included. The link for the mobile to base microwave system is not listed.

Table 2.1. Sample Frequency Plan.

Tucson	12510 MHz Hor. →	← 12210 MHz Hor.	San Xavier
San Xavier	6675 MHz Hor. →	← 6825 MHz Hor.	Kitt Peak
	6685 MHz Hor. →	← 6835 MHz Hor.	
Kitt Peak	6855 MHz Ver. →	← 6705 MHz Ver.	Santa Rosa
	6865 MHz Ver. →	← 6715 MHz Ver.	
Kitt Peak	6795 MHz Hor. →	← 6645 MHz Hor.	Pisinimo
	6805 MHz Hor. →	← 6655 MHz Hor.	
Kitt Peak	6735 MHz Hor. →	← 6585 MHz Hor.	Sells
	6745 MHz Hor. →	← 6595 MHz Hor.	
Kitt Peak	6765 MHz Ver. →	← 6615 MHz Ver.	Cimarron
	6775 MHz Ver. →	← 6625 MHz Ver.	
Cimarron	6665 MHz Ver. →	← 6815 MHz Ver.	South Mountain
	6675 MHz Ver. →	← 6825 MHz Ver.	
South Mountain	12510 MHz Hor. →	← 12210 MHz Hor.	Phoenix
Phoenix	6775 MHz Ver. →	← 6585 MHz Ver.	Pinal Peak
	6785 MHz Ver. →	← 6595 MHz Ver.	
Pinal Peak	12290 MHz Hor. →	← 12590 MHz Hor.	San Carlos
Pinal Peak	6705 MHz Ver. →	← 6825 MHz Ver.	Bylas
	6715 MHz Ver. →	← 6835 MHz Ver.	
Pinal Peak	6665 MHz Ver. →	← 6785 MHz Ver.	Mount Lemmon
	6675 MHz Ver. →	← 6795 MHz Ver.	
Mount Lemmon	6585 MHz Ver. →	← 6705 MHz Ver.	San Xavier
	6595 MHz Ver. →	← 6715 MHz Ver.	

### 3.0 APPLICABLE DOCUMENTS

The requirements and standards set forth in the following sections shall apply to the extent that they are referenced in this specification.

#### Electronic Industry Association Standards

- RS-158 Mechanical Considerations for Transmission Lines in Microwave Relay Applications
- RS-173 Emergency Standby Power Generators and Accessories for Microwave Systems
- RS-195A Electrical and Mechanical Characteristics for Microwave Relay System Antennas and Passive Reflectors
- RS-203 Microwave Transmission Systems
- RS-222A Structural Standards for Steel Antenna Towers and Antenna Supporting Structures
- RS-250A Electrical Performance Standards for Television Relay Facilities
- RS-252 Baseband Characteristics of the Microwave Radio and Multiplex Equipment
- TR-141 Microwave Relay Facilities for Communications
- RS-232C Interface Between Data Processing Equipment and Data Communications Equipment.

#### Federal Communications Commission Rules and Regulations

- Part 17 Construction, Marking and Lighting of Antenna Structures
- Part 91 Industrial Radio Services
- Part 89 Public Safety Radio Services

## **Federal Aviation Regulations**

Part 77        Objects Affecting Navigable Airspace

FAA Circular   Obstruction Lighting and Marking  
AC 70/7460-1B

## **Medical Instrumentation Standards**

“Recommendations for Standardization of Instruments in Electrocardiography and Vectorcardiography,” American Heart Association, January 1967.

4.0 TRANSMISSION PERFORMANCE REQUIREMENTS

4.1 Voice Bandwidth Channels

Each "voice slot" shall comply with the following specific sections of EIA Standard TR-141:

<u>Section of TR-141</u>	<u>Subject</u>
2.1	Telephone Channel Input and Output Impedance
2.2	Transmission Gain Stability
2.3	Telephone Channel Test Signal
2.4	Overload Level
2.5	Telephone Channel Input Power
2.6	Telephone Channel Output Power
3.2	Harmonic Distortion

In addition, all voice bandwidth channels shall meet the following specifications without the use of external equalizer circuits.

- a. Amplitude-Frequency Response – Referred to the response at 1,000 Hz, the amplitude shall not exceed 1 dB or fall below 3 dB in the range of 300 to 3,000 Hz, nor exceed 1 dB outside this range. (Note: This meets both the TR-141 standard and the requirements for C-2 conditioning.)
- b. Envelope Delay Distortion – The envelope delay distortion shall not exceed the following values (equivalent to C-2 conditioning):
  - 1,000 to 2,600 Hz      500 microseconds
  - 600 to 2,600 Hz      1,500 microseconds
  - 600 to 2,800 Hz      3,000 microseconds
- c. Frequency Displacement – As defined in Section 3.3.1 of TR-141, frequency displacement shall not exceed 2 Hz.



## 4.2 Television Channels

The wideband color television channel and its associated aural program channel as measured between any two terminals shall comply with EIA Standard RS-250-A. The specific sections of RS-250-A which are applicable to the system are designated as follows:

<u>Section of RS-250-A</u>	<u>Subject</u>
4.1	Input impedance
4.2	Input signal level
4.4	Output impedance
4.5	Output signal level
4.6	Polarity of the picture signal
5.1	Amplitude versus frequency characteristics
5.2	Low frequency response of the picture signal channel
5.4	Transient response of the picture channel
5.5	Harmonic distortion in the audio signal channel
5.6	Differential gain and differential phase of the picture signal channel
5.7	Signal-to-noise ratio
5.8	Signal-to-hum ratio in the picture signal channel
5.9	Signal-to-interfering tone ratio in the picture signal channel

## 4.3 Telemetry Channel

The telemetry channel for the physiological signals shall be one of the 4 kHz bandwidth slots of the voice bandwidth multiplex channels. The frequency allocation is between 20 and 24 kHz. The center carrier frequency of the telemetry channel shall be 22 kHz. This frequency

modulated carrier system shall have a bandwidth of 500 Hz. The placement of this carrier at 22 kHz shall not degrade the adjacent or other channels within the multiplex system such that the specifications as stated in Section 4.0, Voice Bandwidth Channels, cannot be met. Performance requirements of the telemetry channel are stated in Section 5.11.1 and 5.11.4, FM Modulator and FM Demodulator respectively.

## 5.0 EQUIPMENT PERFORMANCE REQUIREMENTS

### 5.1 Video Performance

#### 5.1.1 Color Standards

Although it is planned that SECAM color<sup>1</sup> will be used primarily on the Arizona TeleMedicine Network, all performance characteristics of transmission equipment and common console equipment shall meet or exceed all EIA and FCC broadcast standards and recommendations for NTSC television.

#### 5.1.2 Camera and Associated Equipment

The cameras provided as part of this system shall be of identical type and model at each terminal site (class "a," "b," and "c" stations). The following specifications shall apply to the camera and associated components.

1. The camera shall weigh no more than 45 pounds including the weight of the lens and view finder but excluding the weight of the mount, cradle head and motor driven tilt/pan head.
2. The camera chain shall provide broadcast quality color television images and shall be completely solid state except for the image tubes.
3. The view finder shall be easily removed.
4. The camera shall utilize three lead oxide pickup tubes. The tubes, arranged in a standard RGB configuration, shall be of separate mesh type.
5. An electrically operated zoom lens (focus, iris, zoom) with local and remote controls shall be supplied. The lens shall have a range of 10 to 1 (15 mm to 150 mm) with a maximum iris opening of at least  $f/2.8$ . A prealigned and sealed color optical system shall be employed interior to the camera.
6. The camera shall be modified so as to provide automatic, remote selection from the control console of either the encoded color output or a monochrome output ("green gun"). The monochrome output bypass shall select the video signal prior to bandpass limiting.

<sup>1</sup>525 line, 30 frames, color subcarrier at 4.43 MHz.

- 2
7. The color encoder shall provide SECAM-60 color television as its output. Color sub carrier shall reside at 4.43 MHz.
  8. Individual channel aperture compensation shall be provided.
  9. Geometric distortion (not including lens effects) shall be no greater than  $\pm 1$  percent.
  10. Intercom connectors, amplifiers, and wire pairs shall be provided.
  11. Signal-to-noise ratio shall not be less than 40 dB at 25 foot-lamberts scene illumination.
  12. Signal-to-noise ratio shall not be less than 50 dB at 50 foot-lamberts scene illumination.
  13. For ease of maintenance, all circuit boards and integrated circuits shall be of the plug-in type.
  14. Output level: one volt peak-to-peak composite signal.
  15. Resolution: not less than 400 lines, center with aperture correction when camera is in the color mode of operation. When the monochrome bypass is actuated, resolution shall not be less than 600 lines center. Modulation transfer at these limits shall be at least 30 percent.
  16. There shall be supplied at each terminal site (class "a," "b" and "c" stations) a permanent wall or ceiling mounted bracket for the support of the camera, lens and tilt/pan unit. The bracket and its installation shall be rigid and shall not create noticeable optical jitter in the television image due to normal vibrations in or near the telemedicine room.
  17. As an alternate portable camera support, a dolly/pedestal/cradle head shall be provided at each site. Manufacturer's specifications as to recommended weight handling capacity of the dolly/pedestal/cradle head shall exceed the total weight of the view finder, camera, lens and motorized tilt/pan head by at least 15 percent.

As part of his camera equipment supplied as a part of this network, the Contractor shall provide a 10-foot and a 50-foot extension cable for each class "a" and class "b" site. These cables shall have the proper fittings and connectors to allow for connection between the camera control console and the camera head.

The cable thus supplied shall contain, in addition to the camera related conductors, a program audio circuit and an intercom circuit. The program audio circuit shall be electrically equivalent to the microphone cords supplied as part of the audio facilities at each site.

### 5.1.3 Television Monitors

#### General

Throughout the Arizona TeleMedicine Network there shall be installed at each terminal site (class "a," "b" and "c" stations), a system-wide standard complement of monitors. As an integral part of the control console there shall be supplied a twin 9-inch (diagonal) monochrome monitor panel. In the following specifications this dual monitor shall be referred to as the "console video monitors." In addition to the console video monitors, the Contractor shall supply a single large screen color video monitor (termed "color monitor" throughout these specifications) and a single large screen monochrome ("black and white") monitor.

#### Console Video Monitors

1. Console video monitors shall be constructed so as to present two complete but separate side-by-side monitors in a single panel suitable for mounting in a 19-inch equipment rack.
2. Console video monitors shall be capable of presenting a monochrome image of 600 line center and corner resolution without geometric distortion greater than 3 percent of picture height.
3. With the exception of the high voltage rectified and kinescope, the monitor is to employ all solid state construction.
4. Video response shall be to 10 MHz  $\pm$ 1 db.
5. Input impedance shall be high impedance or 75 ohms (switchable).

6. DC restoration (sync tip clamp) shall be provided and switchable in or out.
7. Video signal input, composite, shall be 1 volt peak-to-peak  $\pm 50$  percent with all specifications met.

#### **Black and White Monitor**

1. The large screen black and white (monochrome) monitor provided at each site shall be of the cabinet type suitable for either shelf mounting or for mounting using a ceiling supported yoke or pedestal.
2. Screen size shall be 17 inches.
3. With the exception of the kinescope and high voltage regulator, the monitor shall employ all solid state construction.
4. Linearity shall be within 3 percent of picture height.
5. Resolution shall be in excess of 600 lines, center and corners.
6. Video response shall be flat within 1 dB to 10 MHz.
7. Input impedance shall be switchable to either high impedance or 75 ohms.
8. DC restoration (sync tip clamp) shall be provided as a switchable option.
9. Video signal input level, composite, shall be 1 volt peak-to-peak  $\pm 50$  percent with all specifications met.

#### **Color Monitors**

1. The color monitor provided at each site shall produce full color pictures from SECAM-60 encoded color video signals with a color subcarrier center frequency of 4.43 MHz.
2. Screen size shall be 17 inches.
3. Kinescope shall be of the "trinitron" type.

4. The monitor shall be all solid state with the exception of the kinescope.
5. Video band pass flat to 4.43 MHz,  $\pm 1$  dB.
6. Linearity shall be within  $\pm 2$  percent of picture height.
7. DC restoration shall be provided as a switchable option.
8. Video input impedance shall be switchable from high impedance to 75 ohms.
9. Video signal input level shall be 1 volt peak-to-peak  $\pm 50$  percent with all specifications met.

## 5.2 Magnetic Tape Recorders and Playback Units

### 5.2.1 General

There shall be supplied, as a part of each control console at each class "b" and each class "c" station, two record/playback units. One unit, referred to in the following specifications as "video cassette playback/record unit" shall provide a means of logging the television transmissions received by each station where it is installed. It shall simultaneously record both sides of the associated program audio (send and receive). The other unit shall simultaneously log both sides of the exchange transmissions of telemetry and slow-scan TV. Four channels of voice grade audio are therefore required. This unit is referred to, below, as the "audio channel logger."

All units supplied of each type shall be identical in model and manufacturer.

### 5.2.2 Video Cassette Playback/Record Unit

1. This unit shall be completely self-contained with dimensions not to exceed 18 X 20 X 10 inches.
2. Recording tracks shall include two audio channels and one video channel.
3. Format shall be helical scan, full field, employing tape having a width of not less than 1/2 inch.
4. Video response shall be at least to 5 MHz  $\pm 2$  dB.

5. The unit shall accept cassettes having a playing time of at least 60 minutes.
6. Audio response shall be flat 75 Hz to at least 10 MHz,  $\pm 1$  dB.
7. Each unit shall be supplied with 20 blank cassettes each with a playing time of 60 minutes.
8. Video signal to noise ratio shall be greater than 40 dB.
9. Resolution shall be at least 250 lines.
10. Provision for remote control of "play," "record," "fast forward," "rewind" and "stop" shall be available. Indicator lamps to show recorder status (off, red; on, green) shall be provided.

### 5.2.3 Audio Channel Logger

1. This unit shall be no larger than 18 × 12 × 10 inches and shall be designed to be mounted in a standard 19-inch equipment rack.
2. Four simultaneous audio tracks are to be provided so as to allow for the concurrent logging of incoming and outgoing slow-scan TV transmissions and incoming and outgoing telemetry transmissions.
3. The format shall involve either cartridge or cassette packaging, at the Contractor's option. Reel-to-reel machines are not acceptable.
4. Each audio track (channel) shall reproduce a band of frequencies from 100 Hz to 4 kHz with a flat response ( $\pm 2$  dB).
5. Signal-to-noise ratio shall not be less than 36 dB.
6. Tape speed shall not vary from its design specification more than 1 percent in the short term (8 hours). Total harmonic distortion shall not exceed 1 percent.
7. Provision shall be made for remote control of "play," "record," "fast forward," "rewind" and "stop." Indicator lamps as provided for the video recorder shall also be included for the audio logger as well.



8. Outputs from this unit shall be provided on the audio jack panel on the main control console.

### **5.3 Switcher Matrices**

#### **5.3.1 General**

These units, known as "video switchers" and "audio switchers" in the specifications that follow, are to be located at those points throughout the Arizona TeleMedicine Network where more than two duplex links come together and require to be routed on the several independent communication "levels" that are provided. The video switchers must switch both the wideband color video and its associated sound. The audio switchers are those matrices associated with telemetry routing and slow-scan TV routing.

All units provided in this category shall use interchangeable modules and be expandable to at least a 12 × 12 capacity.

#### **5.3.2 Video Switchers**

1. These units shall be all solid state, self-contained utilizing modular construction.
2. Frequency response shall be flat within 0.5 dB to MHz.
3. Cross-talk, worst case, shall not exceed -60 dB as referenced to desired signal.
4. Hum and noise shall not exceed -55 dB, referenced to signal level rms.
5. Differential gain: ±1 percent
6. Differential phase: ±0.2 degree
7. Input and output impedance shall be 75 ohms.

#### **5.3.3 Audio Switchers**

1. These units shall be all solid state, self-contained utilizing modular construction.

2. Frequency response shall be flat within 1 dB 50 Hz to 5 kHz.
3. Cross-talk shall not exceed -50 dB referenced to desired signal.
4. Hum and noise shall not exceed -50 dB, referenced to desired signal.
5. Total harmonic distortion shall not exceed 1 percent.
6. Input and output impedance shall be 600 ohms, balanced.

#### 5.4 Video Amplifiers and Terminal Equipment

Loop-through monitor connections and video signal bridging will not be permitted in the construction of the Arizona TeleMedicine Network, video distribution amplifiers shall be required at all multiple feed points in the system. In addition, each station shall have in its console video line an image enhancer such as the CBS Laboratories, Inc. "Model 8000<sup>1</sup> Image Enhancer" or equal.

Video handling equipment not covered in the other sections of this specification shall have the following performance characteristics.

1. All solid state, modular construction.
2. All incoming video lines to each terminal site, at the console end, shall be connected to differential input distribution amplifiers with clamping circuits. Cable equalization shall be provided for runs in excess of 200 feet.
3. Frequency response shall be flat ( $\pm 1$  dB) to 10 MHz.
4. Differential gain shall be less than 0.5 percent.
5. Differential phase shall be less than 0.25 percent.
6. Isolation between outputs of distribution amplifiers shall be better than 35 dB.
7. Hum and noise shall be held to 55 dB or more below picture level.

<sup>1</sup>Modified by the manufacturer as required to handle SECAM-60.

## 5.5 Audio Equipment

This section of the specification covers that equipment associated with the main program audio channel (associated with the video).

1. Frequency response shall be flat  $\pm 2$  dB from 50 Hz to 15,000 Hz.
2. Harmonic distortion shall not exceed 1.0 percent.
3. Signal-to-noise shall be greater than 50 dB.
4. Console audio mixer shall have an automatic level control (limiter amplifier) associated with it. Both units are to be entirely solid state.
5. Console audio mixer shall be capable of mixing inputs from at least 3 microphones and, in addition, shall, by way of a front switch, handle up to 4 auxiliary high level inputs in sequence.
6. Audio mixer front panel shall include a VU meter and all operating controls.
7. Included with the microphones supplied at each site shall be one fixed, directional microphone mounted on a "gooseneck" adapter as shown on the drawings of the console. In addition there shall be supplied, at each site, 2 lavalier microphones with 15-foot cords and suitable connectors.

All microphones shall be of the moving coil dynamic type. Frequency response shall be 70 to 12,000 Hz or better. Output should be low impedance, balanced.

## 5.6 Multiplex Channel Equipment

1. Standard frequency division multiplex equipment providing a maximum of 12 channels with 4 kHz spacing shall be supplied. The channels shall be used as four wire circuits. Modulation shall be single-sideband, suppressed carrier.
2. All channel modules shall be of the plug-in type.
3. Only those modules actually required to provide the channel service specified at each site (and recommended spares) shall be supplied.

**5.7 Microwave Radio Equipment**

**5.7.1 General**

Heterodyne repeaters shall be used at Cimarron Peak, Mt. Lemmon and South Mountain. All other sites shall be supplied with demodulating-remodulating equipment.

Modulation shall be FM. RF bandwidth shall be 20 MHz. All transmitters shall be type accepted under the appropriate Government rules. To render the receivers less susceptible to adjacent channel interference the Contractor shall supply microwave receivers with the minimum IF bandwidth necessary for proper reception of the associated microwave transmitter's emission.

All microwave and ancillary equipment supplied by the Contractor shall meet the additional conditions and design criteria set forth below.

**5.7.2 Environmental Conditions**

Equipment shall be capable of operation according to these specifications under the following ambient conditions:

Temperature	0 to 45°C
Humidity	up to 90 percent RH at 40°C

Equipment shall not sustain damage from prolonged exposure, either operating or nonoperating, to ambient temperatures in the range of -20°C to 50°C.

**5.7.3 Power Requirements**

The equipment shall be capable of operating from 24-volt or 48-volt direct current power sources to be furnished by the Contractor. Primary power shall be from 115/230 volt 60 Hz single phase mains.

**5.7.4 Metered Parameters**

Provision shall be made for metering the following parameters by means of meters and switches and included as a part of the equipment, or by means of readily accessible test points on the front panels.

- a. All power supply and bias voltages, including high voltage supplied to microwave tubes (if used)
- b. Cathode or beam current of each microwave tube
- c. Rectified diode current of the receiver mixer
- d. AGC voltage of the IF amplifiers
- e. IF output level
- f. Balance of AFC discriminator
- g. Transmitter output power
- h. Local oscillator drive level to the transmit frequency changer (where possible).

Accuracy of built-in meters shall be  $\pm 3$  percent of full scale deflection. Normal meter readings shall fall between 30 and 80 percent full scale deflection.

#### 5.7.5 Electrical Protection

Equipment shall be protected from damage due to overvoltage, undervoltage, short circuits, open circuits, and from incorrect operation of equipment controls and switches by the provision of fuses, circuit breakers, interlock circuits and similar devices. Fuses shall be clearly labeled as to function and capacity. Power circuits provided for maintenance purposes and for ancillary equipment shall be isolated from the radio equipment power circuits by separate breakers or fuses, such that a fault in maintenance or ancillary equipment will not cause a loss of power to the radio equipment. Provision shall be made by means of electrical interlocks, safety covers and similar safety devices to minimize accidental contact with conductors carrying dangerous voltages. Safety covers shall be marked with appropriate warnings, as for example, "DANGER HIGH VOLTAGE" in red, clearly legible letters.

#### 5.7.6 Mounting

Electronic equipment shall be mounted on standard 19-inch racks not exceeding a height which can be conveniently installed in the space available.

### **5.7.7 Modular Design**

All circuitry, with the exception of waveguide and other microwave components, shall be in the form of subassemblies or modules that may be easily disconnected and removed. Preferably, the modules shall use printed circuit card techniques. All plug-in type modules shall be removable from the front without prior need to turn off the equipment.

### **5.7.8 Routine Adjustment**

Any adjustments required during any routine maintenance procedure, including those affecting waveguide components, shall be readily available from the front of the equipment without requiring the equipment to be first turned off and without requiring safety interlocks to be bypassed.

### **5.7.9 Materials**

No fungus nutrient material or material subject to insect attack shall be used in the construction of equipment.

### **5.7.10 Component Requirements**

All solid-state design is preferred. Equipment shall employ all solid-state design except that microwave tubes, such as traveling wave tubes, may be employed if necessary. All semiconductors shall comply with EIA Standards. Circuit designs that require selection of components or parts to achieve desired performance shall be prohibited. Traveling wave tubes must be of the repairable type. All components shall be protected against the effects of moisture, heat, chemical action and foreign materials such as dust and grit.

### **5.7.11 Marking and Finish Requirements**

Each radio transmitter and receiver shall be clearly and permanently marked as to the location it transmits to or receives from. All controls, meters, switches and indicator lamps shall be clearly labeled as to function. Pin jack test points shall be color coded to indicate balanced or unbalanced circuitry. All modules and subassemblies shall be clearly labeled as to function and type number.

### **5.7.12 Identification of Circuit Components**

The designations of each circuitry component, and its value, as referenced in the schematic diagrams, shall be marked on the circuit board adjacent to that component, whenever practical. Where there is insufficient space for legible marking, the component shall be identifiable from component layout diagrams in a maintenance manual.

## **5.8 Teleprinter and Associated Equipment**

### **5.8.1 General**

The digital data equipment requirement must satisfy the need to retrieve information from the computer center near San Xavier. This computer center, operated by Bell Aerospace, is used as the data source for the Health Information System of the Indian Health Service. The present terminals, with hard copy output and keyboard input, operate over voice grade lines receiving and transmitting data asynchronously at 300 bits per second (30 character/second).

Certain voice grade channels throughout the Arizona TeleMedicine Network shall be designated for two-way digital data use with each terminal site having a dedicated line to the computer center. Sites will be grouped to a maximum of 6 and will share a common voice circuit. This shall be accomplished by use of frequency shift keying transmission.

### **5.8.2 Information System Retrieval Terminal**

The terminals provided by the Contractor shall be of the teleprinter type with a page (approximately 8-1/2 X 11) output. They shall have a standard alphanumeric typewriter keyboard with at least a 64 coded character set. Each terminal shall be capable of sending and receiving USASCII coded information at a rate of 10 and 30 characters per second and shall conform to EIA Standard RS-232 for either direct or acoustic coupling to a standard voice grade telephone circuit as an alternative to the data channel set aside for it. The acoustic coupler can be either separate or built-in the terminal. Units so provided shall be of the small portable type suitable to fit within the desk top space to be provided on the console.

### **5.8.3 Modems**

Modems to be provided by the Contractor shall have a standard interface input (RS-232) and be compatible with standard terminals such as are presently in use (TYMESHARE 1030, GE TERMINET 300).

The modems shall employ frequency shift keying and operate asynchronously at 300 bits per second. Each site shall be assigned one of the six set of frequencies of the C.C.I.T.T. standard for frequency shift keying at the rate of 300 bits per second. The modem shall interface directly to the voice channel which shall have the characteristics of the Bell System type 3002 data circuit with C2 conditioning. The appropriate frequency set modem shall be provided at the computer site. This modem shall interface to the Control Data Corporation model 3316 Data Communication Controller as per RS-232 requirement.

### 5.9 Facsimile Equipment

As a local alternate means of transmission, facsimile transceivers shall be provided at Sells, Santa Rosa and the University of Arizona Medical Center. These units, in each case, shall be portable and shall be equipped so as to allow their interconnection through the 4 kHz circuit normally associated with the slow-scan television unit either via an acoustically coupler or direct wire. A patch cord arrangement or switch shall be provided at each of the three sites to permit the use of either facsimile or slow-scan television as alternate modalities.

The facsimile units shall be of the "business" type with resolution of 90 lines per inch or better. Transmission time for 8-1/2 × 11-inch page shall not exceed 6 minutes. Design shall be such that minimum operator manipulation is required. The transceiver shall be capable of sending and receiving charts, prescription orders, laboratory data and the 50 millimeter electrocardiographic strip tracing.

### 5.10 Slow-Scan Television Equipment

Slow-scan monochrome television transceivers shall be provided at all terminal locations. Since it is desirable to preserve the resolution and grey scale, the Contractor shall utilize magnetic disc storage as the means of achieving scan conversions. Standard 525, 60 field (2:1 interlace) cameras shall be employed.

The equipment shall be capable of producing a 525 line video image with a transmission time of 120 seconds or less over a designated voice channel. It shall be capable of displaying X-ray images and shall have a horizontal resolution in excess of 500 TV lines after transmission. It shall be designed to expose and read out upon command a quality TV picture. It shall have an optical zoom feature which will allow a small area of the image to be displayed on the entire viewing area of the monitor. The monitor itself shall be compact and included as part of the slow-scan television console. The monitor devices shall have the same basic electrical characteristics as called for in connection with the control console equipment. A contrast control and switchable de restoration shall be provided as operator controls. The slow-scan TV system shall reproduce at least 10 steps of grey.



## 5.11 Telemetry Channel Equipment

### 5.11.1 FM Modulator

A voltage controlled oscillator will be used for the telemetry of physiological signals. All signals will be sent over a single FM channel (dc-500 Hz) with appropriate filtering and conditioning before and after transmission of signals.

The equipment at the transmission end (this is a one-way system) will consist of the following:

1. voltage controlled oscillator and line amplifier
2. signal conditioner and filter for heart sounds
3. signal conditioner and filter for spirometry
4. signal conditioner and filter for ECG
5. calibration unit
6. switching unit
7. power supply and mounting hardware

This is shown in Figure D.47.

#### Voltage Controlled Oscillator

Center frequency shall be 22.00 kHz with proportional bandwidth deviation of  $\pm 7.5$  percent for full scale.

Frequency response must be flat ( $\pm 3$  dB) from dc to 500 Hz.

Full bandwidth deviation must correspond to an input of  $\pm 2.5$  volts (peak-to-peak) adjustable input voltage offset control is desirable but not mandatory.

### **Input Characteristics**

The input shall be single-ended and referenced to signal ground. The input impedance of the voltage-controlled oscillator shall be a minimum of 100,000 ohms shunted by less than 100 picofarads.

### **Stability**

The center frequency shall be stable within  $\pm 0.1$  percent of the nominal center frequency for 15 hours after a 15 minute warm-up, and the drift shall be less than  $\pm 0.01$  percent of center frequency per degree centigrade change in the ambient temperature.

### **Linearity**

The linearity of the voltage-controlled oscillator shall be within  $\pm 0.1$  percent of full bandwidth, measured from the best straight line drawn between the end points.

### **Power Supply Requirement**

The input power requirement shall be 120 volts  $\pm 10$  percent, 47 to 73 Hz, single phase.

### **Line Voltage Stability**

A 10 volt change in line voltage anywhere between 108 and 132 volts shall cause a change of less than 0.1 percent of center frequency on any unit.

### **Overload Recovery**

If an overload voltage of up to 1,000 percent is applied for any duration and then removed (50 volts maximum) the input amplifier shall recover to within 1 percent of full bandwidth within 2.0 milliseconds.

### **Amplitude Modulation and Distortion**

The sine wave output of the voltage-controlled oscillator shall contain less than 1 dB of amplitude modulation and less than 1 percent total harmonic distortion for deviations of  $\pm 7.5$  percent or less.

## **Output**

The output current capability is to be 10 milliamperes. The unit shall be designed so that a short circuit on the output will not damage the unit. It shall be designed to be compatible with microwave telephone multiplex equipment.

## **Output Noise**

The voltage-controlled oscillator shall have an output noise of less than 0.4 percent of full scale over the bandwidth with the input leads shorted directly through 1,000 ohms or less.

## **Operating Temperature Range**

The units shall operate within the above specifications within a temperature range of +10°C to +50°C circulating air.

## **Mounting Panel**

It shall be standard EIA 19-inch rack size.

### **5.11.2 Signal Conditioning for Transmission**

#### **Heart Sounds Conditioning**

This conditioner may be included with the electronic stethoscope instrumentation. Specifications for the electronic stethoscope follow.

The frequency response of the dynamic microphone and heart sound amplifier shall be from 25 to 1000 Hz (3 dB down).

It shall have several low end filter selections which limit the low end of the band at 25, 50 and 100 Hz (3 dB down). The roll-off characteristics shall be 12 dB per octave with constant amplitude characteristic response.

The gain shall be adjustable up to at least 45 dB.

The output voltage shall be  $\pm 2.5$  volts for full scale. The voltage shall be clamped at a level of 125 percent of full scale and an indicator provided so that the operator may adjust the

volume to keep within range of the voltage controlled oscillator. An internal volume adjustment shall adjust the gain to the headphones so that 80 percent full-scale output voltage represents "normal" listening volume.

This output shall have the same dynamic range and frequency response as the telemetry output.

It can be either battery or line powered.

It may be incorporated into a single hand held unit (microphone and amplifier combined) or the amplifier and controls may be a separate unit which will be mounted with other examining equipment on a movable cart.

#### **Spirometry Conditioning**

This unit shall have the amplification (attenuation), filtering and impedance requirements necessary to interface the spirometer to the common voltage controlled oscillator. This unit may be an integral part of the spirometer or a separate module mounted within the examining equipment on the movable cart.

The frequency response shall be from dc to 100 Hz (3 dB down).

The signal-to-noise ratio shall be greater than 48 dB with input shorted through a 1000-ohm resistor.

Output must match input characteristics of voltage controlled oscillator. It shall be limited to 125 percent of full scale. The signal shall be compatible with the University of Arizona automatic spirometry program which uses a 13.5 liter spirometer for input.

#### **Electrocardiographic Conditioning**

This unit shall contain the amplification (attenuation), filtering and impedance requirements necessary to interface to the common voltage controlled oscillator.

This unit may be provided as an integral part of the electrocardiograph.

It shall accept the single-ended output signal of a standard 12 scalar lead electrocardiograph machine. This signal has a full-scale range of  $\pm 2.5$  volts which represents  $\pm 2.5$  millivolts at the body surface.

It shall have unity gain. It shall have a frequency cutoff at 200 Hz (3 dB down) with a constant amplitude filter response and a roll-off of 12 dB octave thereafter.

Noise shall be less than 7 millivolts rms with the input shorted through a 1000-ohm resistor. If separate, input shall be through a BNC connector.

Output shall be  $\pm 2.5$  volts to conform to the input of the voltage controlled oscillator. This output shall be limited to 125 percent of full scale.

### **5.11.3 Calibration and Switching Unit For Transmission**

A means must be provided for readily injecting test voltages of: plus full scale, plus 1/2 full scale, zero, minus 1/2 full scale and minus full scale, and then calibrating the frequency output of the voltage controlled oscillator. Voltage source and frequency counter need not be an integral part of the telemetry instrumentation but may be part of test equipment.

Switching must be provided to switch any one of the three signal conditioning units to the voltage controlled oscillator. Switching must be such so that amplifiers or voltage controlled oscillator do not "lock up." Transients are to be controlled to within reasonable limits.

### **5.11.4 FM Demodulator**

All signals will be received over a single FM channel via a discriminator with filtering and conditioning appropriate for the various signals.

The equipment at the receiving end consist of the following:

1. Discriminator
2. Signal conditioner and filter for heart sounds
3. Signal conditioner and filter for spirometry
4. Signal conditioner and filter for ECG
5. Calibration unit
6. Switching unit

7. Power supply and mounting hardware.

This is shown in Figure D.48.

**Discriminator**

Center frequency shall be 22.00 kHz with proportional bandwidth deviation of  $\pm 7.5$  percent for full scale.

Frequency response must be flat ( $\pm 3$  dB) from dc to 500 Hz.

Full bandwidth deviation must correspond to an input deviation of  $\pm 7.5$  percent.

**Output Current**

The output current capability shall be at least 10 mA.

**Output Impedance**

The output impedance for the unit shall be 1.0 ohm or less.

**Output Protection**

The unit design will include output circuitry protection, such that it cannot be damaged in any way by a short circuit on the output terminals.

**Output Load**

The unit shall accept capacitive loading on the output without oscillating as long as the RC load combination is not so low that the output current drain on the unit exceeds its maximum output capability.

**Harmonic Distortion**

For deviation ratios of 5 or greater, the harmonic distortion for bandedge-to-bandedge modulation shall not exceed 0.5 percent for any modulation frequency up to the cutoff frequency of the channel.

### **Power Switch**

Each power supply unit shall be equipped with a control for applying or disconnecting primary power (120 V ac).

### **Discriminator Balance Control**

A balance potentiometer shall be provided for each discriminator to adjust center frequency.

### **Data Cutoff Frequencies**

The unit shall operate at data cutoff frequencies of 500 Hz.

### **Input Impedance**

The individual unit input impedance shall be 50,000 ohms resistance minimum.

### **Dynamic Input Signal Range**

The dynamic input signal range capability of the unit shall be at least from 50 mv to 2 volts rms (60 dB).

### **Amplitude-Modulation Rejection**

Operation of the unit with a deviation ratio of 5, introducing a 20 dB step of input amplitude within the 60 dB dynamic input range shall not cause a peak transient of more than 1.0 percent of full bandwidth.

### **Adjacent Channel Rejection**

Cross talk due to nearest-bandedge deviation of an adjacent  $\pm 7.5$  percent deviation, IRIG channel shall be attenuated at least 60 dB where the interfering signal has an amplitude 26 dB greater than the desired subcarrier and where the desired subcarrier is anywhere within its band.

### **Linearity**

The unit shall be capable of maintaining linearity to within  $\pm 0.25$  percent of bandwidth best straight line.

### **Output Noise**

With the unit operating a maximum bandedge output voltage, the signal to noise ratio shall be greater than 48 dB.

### **Output Zero Stability**

After a 30-minute warmup, the unit shall be capable of maintaining an output zero stability to within 0.5 percent of bandwidth for deviations of  $\pm 7.5$  percent providing the unit is maintained at a constant temperature over a 15-hour period.

### **Output Voltage**

The output voltage shall be single-ended and referenced to ground. Open-circuit bandedge output voltage shall be adjustable between  $\pm 1.5$  and  $\pm 10$  volts. The output voltage shall be limited to 125 percent of bandedge voltage, or 13 volts, whichever is less. Deviation sensitivity shall be positive.

### **General Requirements**

#### **Power Supply Requirement**

The input power requirement for each power supply shall be 120 volts  $\pm 10$  percent, 47 to 420 Hz single phase.

#### **Temperature Range**

Each discriminator shall be capable of operating properly when subjected to ambient temperatures between  $+10^{\circ}\text{C}$  to  $+50^{\circ}\text{C}$  circulating air.

#### **Mounting Panel Size**

The overall panel mounting requirements are a standard EIA type rack.

#### **Weight**

The weight of the discriminator and power supply shall be kept to an absolute minimum commensurate with good engineering design and the detail requirements for the individual equipment.



### **Maintainability**

Major plug-in printed circuit component boards shall be easily accessible on the discriminator unit when out of the equipment rack.

Special tools and/or extenders required in the maintenance and test of the discriminator assembly shall be made available for procurement upon request.

Test points for monitoring the subcarrier input frequency and/or level and discriminator output shall be available on the front panel to facilitate test and servicing of the unit.

### **Output Filter Roll-off Rates and Characteristic Response Curves**

The output filter characteristic response shall be constant amplitude. The roll-off rate after cut-off shall be 18 dB/octave. It shall be at 500 Hz.

#### **5.11.5 Signal Conditioning for Reception**

##### **Heart Sounds Conditioning**

This unit shall be an amplifier with a flat frequency response of 20 Hz to 600 Hz (3 dB down). It shall have a dynamic range of 60 dB.

It shall have an internal control to adjust the intensity of the heart sounds. The signal-to-noise ratio over the bandwidth with the input shorted through a 600-ohm resistor at full gain shall be less than 48 dB.

It shall have an output jack for a standard high quality dynamic type headphone. The headphones should be well cushioned to shield against room noises. This unit shall be mounted in the control console at all class "b" and class "c" stations.

The selection of gain and filter cutoffs will be performed by the examining personnel. The remote consultant listening to the sounds serves to monitor, direct, and consult with the examining personnel. Therefore, there shall be no external controls on this unit.

### **Spirometry Conditioning**

This unit shall be an amplifier with a frequency response of dc to 30 Hz. The gain shall be adjustable by an internal control to give an output range of  $\pm 2.5$  volts to  $\pm 10$  volts. The normal full-scale input is  $\pm 2.5$  volts. The noise level shall be less than 8 millivolts rms over the bandwidth. The filter shall be a constant amplitude type with roll-off after the cutoff frequency (30 Hz) of 12 dB/octave. It shall have an internal offset adjustment such that the bipolar input can be made unipolar (i.e.,  $\pm 2.5$  volts in, to 0 to +5 volts out). When switched to the output of the discriminator, the performance of the discriminator and of the amplifier shall not be degraded.

### **Electrocardiographic Conditioning**

This unit shall interface the output of the discriminator to the high level input of an electrocardiograph (nominal 1 volt/centimeter sensitivity) or other similar voltage recorder. This unit shall be a single-ended input and output voltage amplifier with a frequency response of dc to 45 Hz (3 dB down). The filter limiting the high frequency response shall be of the constant amplitude type with the roll-off after cutoff (45 Hz) of 12 dB/octave. It shall have an internal control to adjust the gain over a 10 dB range. It shall have an internal control to adjust the offset over the entire range at unity gain. The input impedance shall be 100,000 ohms or greater. Output impedance shall be less than 100 ohms. It shall have at least a 10 milliamperere output current capability. It shall have overload and short-circuit protection for the input and output. The output connector will be a BNC type (female).

#### **5.11.6 Calibration and Switching For Reception**

A means must be provided for readily injecting test frequencies into the discriminator: plus full bandedge, plus 1/2 bandedge, center frequency, minus 1/2 bandedge and minus full bandedge and then calibrating the output voltage of the discriminator. Frequency source and voltmeter need not be an integral part of the telemetry instrumentation but may be a part of the test equipment.

Switching must be provided such that any one of the three signal conditioning units can be switched to the output of the discriminator. Switching must be such that amplifiers and the discriminator do not "lock up." Transients are to be controlled to within reasonable limits.

## 5.12 Wireless Headsets

The Contractor shall provide wireless headsets for use at each control console installed at class "a" or class "b" sites including the mobile. These headsets are required in order to permit the medical operator (CHM or physician) to listen privately to the program audio channel. When it is desired not to use this device, program audio will be supplied via an amplifier/loudspeaker built into the console. This option shall be switchable using a front panel control.

The wireless headset itself should be lightweight and self-contained. The console mounted transmitter and the headset receiver must permit clear reception of the audio signal anywhere within the telemedicine room and its immediate vicinity.

The following technical specifications shall apply:

Audio Frequency Response of System:  $\pm 2$  dB, 300 to 3,000 Hz

Transmitter Power Output: 100 milliwatts (maximum)

Modulation Type: FM

Receiver Battery: rechargeable type with charger unit supplied by Contractor to act as holder for receiver unit when not in use

Battery Capacity: 12 hours of continuous operation

Transmitter Frequency: As assigned in the 148-174 MHz band.

## 5.13 Clinical Equipment

At Bylas and within the mobile unit, the Contractor shall supply the following major medical equipment. General consumable supplies such as alcohol swabs, throat sticks, tissues, pencils, paper, etc. are not specified and need not be supplied by the Contractor. Brand names are used for a purely descriptive purpose, "or equivalent" is to be implied.

5.13.F

**Medical Equipment List – Major Items, Each of Two Sites  
(quantity of one unless specified otherwise)**

<u>Item</u>	<u>Description Specific Mfr. or Equivalent</u>
Audiometer	Maico MA16
Blood Pressure Unit	Baumanometer, Mercury 300 mm
Cameras	Polaroid ED10 (Microscope) CU5 (Close-up)
Cauterizer	Hyfrecator, Birtcher
Centrifuge	Microhematocrit Centrifuge, Adams; Clinical Centrifuge – International Model CL
Electrocardiograph	Hewlett-Packard 1500A
Electronic Stethoscope	Hewlett-Packard 1506B
Eye Chart	Snellen Wall Chart
Incubator, Bacterial	Imperial J1600
Microscope	American Optical
Ophthalmoscope-Otoscope	Welch Allyn
Oxygen	
Refrigerator	
Scales; adult, baby	Detecto
Skin Fold Caliper	
Refractometer	American Optical
Spirometer	Collins P700 with Potentiometer P372A; Collins Timed Vitalometer P700
Tonometer (Scheoctz)	R. O. Gulden Company

5.13.2      **Personal Equipment**

<u>Item</u>	<u>Description Specific Mfgr. or Equivalent</u>
Reflex Hammer	
Stethoscope	Littman 3M
Tape Measure	Steel or Linen
Head Lamp	
Laryngeal Mirror	
Tuning Fork 128 cps	

5.13.3      **Basic Furnishing**

<u>Item</u>	<u>Description Specific Mfgr. or Equivalent</u>
Examination Table	
Incandescent Floor Lamp	Luxo Style
Desks, Chairs, etc.	

5.13.4      **Laboratory**

<u>Item</u>	<u>Description Specific Mfgr. or Equivalent</u>
Unopette System	Bector Dickerson Company
Bilelabstix	Amex #2814

## 6.0 MOBILE UNIT AND SUPPORT RELAY

### 6.1 General

Although shown on the system map as a class "a" station, the mobile unit design involve major modifications to the plans proposed for the usual fixed clinic to be incorporated as part of the Network. Nevertheless, the same basic "package" consisting of terminal equipment, control console, cameras, lights, monitors and microwave equipment shall be provided.

An on-board generator shall be provided to supply electrical power to the unit at fixed positions. From any point within a 21-mile radius it shall be possible (line of sight permitting) for the mobile unit to establish contact with the relay site and to, thereby, enter the Network on a full service, wideband basis. In addition, a set of microwave equipment will have to be provided at the fixed relay point in Pisinimo. A suitable tower, equipment shelter, and fence will also be required at the relay site. These items are all contractor responsibilities.

### 6.2 Mobile Layout and Objectives

The objective of the Arizona Health Network is to alleviate the health service problems resulting from geographic separations. A mobile unit, fully equipped with primary health care clinical facilities as well as communications equipment would go even further in bridging these gaps.

In designing the mobile health care and communications unit and its supporting relay station, the basic goal was to provide as many of the health services as would be found at any other field health station in the system.

The diagram, Figure D.49, shows a layout for a 25- by 8-foot self-propelled mobile unit. The various equipment and medical areas are noted on the diagram. As can be seen, many of the usual activities of a health station can be performed within the mobile unit. For example, a well baby exam could be conducted by one CHM while another is conducting a thorough physical examination in the general examination room.

### 6.3 Vehicle Requirements

#### 6.3.1 General

It shall be a self-propelled vehicle such as an International Harvester CO1710A or equal tilt cab and chassis. All components are to be of the heavy duty type.

Body shall be installed on chassis frame so that it is free of wheel housings, giving a straight-through floor of approximately 25- by 8-foot interior dimension. Height shall be at least 7 feet.

Walls, ceiling and floor shall be fully insulated. Unit shall have sufficient crossmembers and framing to ensure sufficient strength for anticipated payload and off-road use of vehicle.

Stabilizing jacks shall be provided to limit vibration during stationary service. Jacks shall be installed as a part of the vehicle's undercarriage and shall be of the hydraulic type, self-leveling and operated from inside the vehicle.

Provision shall be made to secure all equipment during operational transit. This includes positive securing devices on all cabinets.

#### 6.3.2 Electrical System

It shall be wired to receive 4-wire, 120/240-volt, 60-Hz, single-phase power from the on-board generator or local power sources via a lead-in cable. It shall have 20-amp, 120-volt circuits for the equipment, lights and receptacles. It shall have 240-volt circuits for air-conditioning and electrical heating units. It shall have duplex receptacles as indicated.

#### 6.3.3 Lighting

It shall have fluorescent lights mounted to give a minimum light density of 75 footcandles at working distances in all parts of the room.

#### 6.3.4 General Examination Room

It shall have a Hamilton 4K31 (or equivalent) steel examining table which includes: Fit-All stirrups, Hide-A-Roll Ster-O-Sheet dispenser, pull-out rubber tread foot step, front drawer and side cupboard, dual electric outlet, upholstered leatherette top and lockable wheels. Dimensions are 49-3/4 by 22 by 31-5/8 inches. Extended length is 68-3/8 inches. Provide a stool with a back rest.

Build in a formica surfaced work counter and install a stainless steel sink with running water. Provide drain for water. Provide cabinets above and below work counter.

Other items to be installed are specified elsewhere. They shall be installed as shown in Figure D.49 with securing devices.

#### **6.3.5 Interview Area**

It shall utilize the area adjacent to the console equipment. It shall be wired for use of a teleprinter which includes power receptacle and data cable.

#### **6.3.6 X-ray Area**

It shall have an X-ray machine such as a GE CSX-110 or equivalent. The table is to be mounted above the generator compartment. The table may be stationary with a movable bucky. It shall have a variable intensity view box for the X-ray mounted on the wall. All wall and generator compartments shall be lead lined as per applicable safety codes. Developing tanks shall be installed and secured. Storage cabinets shall be provided above developing tanks.

#### **6.3.7 Laboratory Area**

It shall have a built-in formica work counter with stainless steel sink with running water. It shall have at least a 4-cubic-foot refrigerator. It shall have a work counter and storage cabinets above the refrigerator. Securing devices or secure places must be provided for equipment such as centrifuge, microscope, glassware, etc. It shall have a formica drop leaf counter mounted on the wall for examination of babies and small children.

#### **6.3.8 Lavatory**

It shall have a flush toilet with holding tank. It shall have a stainless steel sink with water and small counter. It shall have a mirror, support rails and hooks for clothing. It shall have a pass-through for specimens.

#### **6.3.9 Generator**

It shall have at least a 15-kW Onan, or equivalent, 120/240-volt, 60-Hz, single-phase generator. It shall be installed for easy servicing, proper heat and exhaust dissipation and connected to vehicle gas tank for fuel supply. A remote stop/start button shall be installed within interior body.



### **6.3.10 Air Conditioning/Interior Heating**

It shall have a Carrier Model 51DW270-301 Deluxe Weathermaker, 22,500 Btu cooling/17,500 Btu heating unit, 208/230-volt, 60-Hz, single-phase or equivalent.

### **6.3.11 Supplementary Heating**

There shall be installed an electric fan blower heater (at least 3,000 Btu) above the entrance door. It shall be thermostatically controlled. There shall be in each of the main three areas a Chromalax or equal thermostatically controlled electric blower heater at appropriate locations.

### **6.3.12 Hot Water Heater**

It shall have at least a 20-gallon hot water heater and appropriate water pump to pressurize the water system.

## **6.4 Support Relay**

### **6.4.1 General**

A "bubble top" radio-transport dome shall be provided as an integral part of the mobile unit. A band of optically transparent material about 10 inches wide shall be provided in the construction of the dome. This band will permit a small self-contained monochrome television camera installed inside the dome to have an unobstructed view through a full 360 degrees of the horizon as seen from the position of the vehicle. This closed circuit camera shall be permanently mounted to the support axis of the 2-foot microwave "dish" also contained in the dome. The dish and the camera will always point in the same direction and shall be controlled, by mechanical linkage, from a handle located beneath a ceiling panel in the vehicle's main examination area. The camera will permit the vehicle's operator to position the antenna by aligning the image of the Pisinimo relay tower with the crosshairs as presented on the control console monitor.

### **6.4.2 Relay Antenna and Support**

A parabolic (dish) antenna of a similar type and size to that contained in the vehicle's dome shall be provided atop the Pisinimo relay tower. This 2-foot Pisinimo relay dish shall be steerable and controlled by electric motors in suitable weatherproof housings near the antenna.

#### **6.4.3 VHF Radio Link**

A full duplex voice operated VHF radio transmit and receive link shall be provided between the mobile unit and the relay site to carry positioning control commands as issued by the vehicle operator. In addition to the carriage of positioning control tones, this link shall be arranged to serve as the method of initial communications for the Administrative Voice Channel. The VHF (voice) link shall automatically be used whenever the AdVC control panel is activated prior to microwave antenna alignment. After alignment has been accomplished, local and remote sensors shall be provided so as to automatically change the AdVC over to its usual "slot" in the microwave baseband.

The mobile radio shall be a General Electric MASTR-II or equivalent operating over a frequency range of 150 to 160 MHz with a power output of not less than 30 watts.

The mobile base station shall be a wall cabinet mounted unit with extended local control, the General Electric MASTR Professional Series or equivalent with a power output of not less than 60 watts.

#### **6.4.4 Relay Antenna Alignment**

Whenever the microwave signal received threshold sensors indicate nonalignment of the microwave antenna(s), the received VHF demodulated signal at the relay site shall be monitored by the antenna positioning device. Tones generated by the operator within the remote vehicle shall be received by this device and used to change the altitude and azimuth of the relay site's steerable microwave antenna. Weatherproof electric drive motors and solenoid-operated brakes will direct and lock the antenna in any position within the operating range of the unit. The operating range will encompass 360 degrees of rotation (azimuth) and between +1 and -15 degrees as referenced to the horizon (altitude). The vehicle shall be able to establish wideband contact with the relay (hence, the network) from any point within line of sight of the tower and beyond 300 feet from the base of the tower.

#### **6.4.5 Mobile Unit Antenna Alignment**

As pointed out, alignment of the mobile unit's own antenna will be accomplished manually with the assistance of the closed circuit television camera. Because of the generally clear weather conditions in Southern Arizona, this method should suffice. Nevertheless, the Contractor shall provide for an alternate means of aligning the antenna to be called "dead reckoning." Dead reckoning would require that the mobile operator be provided with a prepared "local table of

coordinates" which would tell him (or her) specific settings for altitude and azimuth for sections and sites in the service area of the vehicle. These coordinates shall be displayed in quadrant form on an area map. Calibrated setting circles shall be provided on the manual control for the vehicle's dome-mounted dish to allow this approach to be used. The dead reckoning method will be used as a backup method of alignment, especially under bad weather conditions. Furthermore, this method may be of use even in good weather when the unit is operating at near its maximum range. In these cases, when the distant relay tower is difficult to discern, the dead reckoning method will be used for coarse adjustment (in effect to "find" the tower) and the CCTV camera image could then be used for "trim."

#### 6.4.6 Positioning Tone Controls

The tone controls to be provided for antenna alignment commands shall be "touch-tone" codes impressed upon the VHF voice channel (AdVC) transmitted from the mobile unit. Because of relatively wide beam of the small diameter antennas used, only a few azimuth and altitude positions need be made available for use by the mobile operator in initiating commands to the relay site's positioning apparatus. A minimum of 60 azimuth "codes" shall be provided for alignment of the relay antenna in the horizontal plane. At least seven codes shall be provided for control in the vertical plane. A standard 12-digit touch-tone pad shall be supplied in the mobile unit for the purpose of originating these tone commands.

The mobile operator would be required to use a map similar to that described for dead reckoning of the mobile's manually positioned antenna. In this case, however, use of the map is not optional. A map of the mobile unit coverage area, with appropriate overlay, shown in Figure D.50 shall be provided. The numbers indicated in the example sector of the overlay represent two digit codes to be keyed in upon the AdVC when it is in the VHF mode. The first two digits in each sector refer to the azimuth positioning command and the second two digits represent the altitude command. Assignments of the codes shall be as suggested on the following tables.

Azimuth (referenced to north)

<u>Code</u>	<u>Direction (degree)</u>
1-1	0
1-2	6
1-3	12
.	
.	
.	
1-0	54
2-1	60
2-2	66
.	
.	
.	
2-0	108
.	
.	
.	
.	
6-0	354

Altitude (referenced to horizon as 0 degrees)

<u>Code</u>	<u>Direction (degree)</u>
7-1	+1
7-2	0
7-3	-0.5
7-4	-1
7-5	-4
7-6	-9
7-7	-15

To further "peak" the alignment of the relay dish, it shall be possible for the mobile operator, after using the proper positioning codes (as indicated above) to initiate a code such as "# - #." This code shall cause the relay site positioning apparatus to change over to an automatic or "maximize" mode. The apparatus shall be so designed as to not accept this code unless its microwave receiver is being presented with a signal level of within 6 dB of a preset level to have been programmed into the device based on the altitude code previously received.

In the automatic mode, the positioning apparatus shall seek to maximize the receive signal (AGC) by "hunting." After a reasonable period (30 seconds), the hunting may be disengaged. The control mechanism shall then go to rest mode to await further orders via the VHF system.

## 7.0 OTHER TECHNICAL REQUIREMENTS

### 7.1 Cable Requirements

All electrical power wiring is to be installed in conduit. Conductor size and insulation breakdown voltage requirements are to be dictated by the peak load expected and in full compliance with the National Electrical Code, local ordinances and institution policy.

With the exception of multiple conductor camera cables (if needed), all cable and wire used throughout the Arizona TeleMedicine Network for internal (building) interconnection shall be of the following types. Camera cable is to be as recommended by the camera manufacturer.

- a. Where video or coaxial cable is called for, use Belden 9231 or equal. Install one spare for each pair required.
- b. Where RF television cable is required, use Times Wire JT-1412-JM (aerial) or JT-1412-J with armor (direct buried).
- c. Where multiple pair audio cables are required or called for, use "Beldfoil" (Belden) 9773 (3 pair), 9774 (6 pair), 9775 (9 pair), 9776 (12 pair), or 9777 (15 pair). Contractor shall select the next highest pair count above that count which will meet the actual circuit requirement. For example, should three pair be needed in a particular instance, install 9774 (6 pair). Should the case be that between 13 and 15 pair are required, install both 9777 and 9773.

Installation of all cable including electrical conduit, power cable, buried RF cable, video cable, audio pair cable and signal wires shall be the responsibility of the Contractor, with one exception. The exception is the wiring at the University of Arizona Medical Center where all work will be performed by the Department of Physical Resources, University of Arizona Medical Center. The Contractor shall accept fiscal responsibility for this work and shall promptly pay as billed by the Department of Physical Resources. The Contractor shall coordinate the scheduling and final specifications as to outlet placement, etc., with the Department of Physical Resources immediately following the award of this contract.

All wiring and cabling within each building and within each room at terminal sites shall be installed in a neat and workmanship like manner. Contractor shall install all cables, wires and conduit above false ceilings or within walls where this is feasible. Where agreed to by the Project

Director, cables, wires and conduit may be wall mounted and covered by suitable wood or hardboard channels painted or stained to match the room walls. Contractor is advised that the Project Director retains the right to reject any and all cable installation work on the grounds of poor appearance. The Project Director's decision is to be regarded as final and binding and shall not be regarded as a change in project scope.

Generalized cable route information is shown on the site sketches and floor plans for each station presented as Figures D.12 through D.25.

## **7.2 Equipment Shelters, Appurtenances, Interface and Coordination**

### **7.2.1 General**

Adequate radio equipment space may be assumed as available at the following sites: Santa Rosa, Sells, Tucson (University of Arizona), Mr. Lemmon, San Carlos, Pinal Peak, Bylas and South Mountain. See Figures D.12 through D.25 for additional information regarding sites.

### **7.2.2 Mt. Lemmon**

The Mt. Lemmon equipment space will be secured, through a rental arrangement, by the University of Arizona Medical Center. This proposed rental agreement will include power, stand-by power, rack space and heat. Tower construction is required and shall be the sole responsibility of the Contractor. The Contractor shall provide whatever assistance and aid requested by the Project Director in coordinating the utilization of this site as well as all others in this phase of the Arizona TeleMedicine Network construction.

### **7.2.3 Bylas**

Bylas field health station is to be supplied with a mobile home type trailer as an annex to the existing building. This addition to the field health station to accommodate the TeleMedicine facilities is to be provided by others and is not a cost item for consideration by the Contractor. All wiring, cabling, conduit work, and floor plan modifications are the Contractor's responsibility. The Contractor is to provide all office furniture, examination table, and miscellaneous medical items as well as all components directly associated with the terminal site installation. A tower is required at this site.

#### 7.2.4 Pinal Peak

A 10-foot X 10-foot block building owned by the Bureau of Indian Affairs (BIA) is to be made available for joint use by the Arizona TeleMedicine Project. To provide additional space within the building, an existing propane gas stand-by power system is to be removed by the Contractor. This unit is to be disposed of according to instructions to be provided by the BIA. A new generator, with an appropriate weather housing, shall be installed by the Contractor at some point near the existing building. This unit shall have sufficient power producing capability to drive both the existing BIA radio equipment and the proposed Arizona TeleMedicine Network equipment. Gas storage capacity shall be provided by the Contractor such that all equipment can be supplied with stand-by power for at least 72 hours.

A new tower is to be provided by the Contractor. The existing BIA tower is to be removed by the Contractor and disposed of in accordance with instructions to be provided by the BIA. The Contractor shall relocate the existing VHF antennas to the top of the new tower. The Contractor shall have the responsibility of assuring uninterrupted operation of the existing radio service provided at this site and shall render all assistance as requested by the BIA in this connection. Contractor shall provide an appropriate ice shield to protect the BIA building from falling ice.

It is recognized that the space at this site is severely limited. Nevertheless, the Contractor shall arrange all new and existing equipment within the building such that maintenance can be effected without the need to disconnect waveguide or to move equipment racks. Wall-mounted equipment shall be permitted so long as swing-out or roll-out shelves are used.

#### 7.2.5 University of Arizona Medical Center at Tucson

Space and electrical connections for the equipment will be provided by the Medical Center in the penthouse. A tripod antenna support shall be utilized on the roof of the floor immediately below the equipment penthouse. The Contractor shall situate the antenna such that its visibility from the ground is minimized but without attenuation of the radio path. A suitable support structure shall be provided by the Contractor to keep the waveguide above the roof level and away from potential damage. The waveguide support structure shall be constructed and painted such that it does not present a hazard to those who may be present on the roof at any time. The Project Director shall have the right to accept or reject this and any other part of the system on grounds of poor workmanship or appearance.



**7.2.6 San Carlos**

Equipment space is available at this hospital. Electrical wiring requirements are minimal. A tower is required.

**7.2.7 Sells**

Equipment space is available at this site. A tower is required. Electrical power and wiring considerations are minimal.

**7.2.8 South Mountain**

Equipment space and adequate tower space are available at this site through an arrangement between the Arizona TeleMedicine Network and KAI T-TV.

**7.2.9 Cimarron Peak**

The Contractor is cautioned that this site is totally undeveloped. No commercial power is available. Access to the summit is only possible on foot or via helicopter.

It is absolutely required that the site be treated as limited access relay. Redundant gas powered electric generators shall be provided to assure continuity of operation. Final design and construction of this facility shall be consistent with its limited accessibility which may involve only 12 visits per year for maintenance, repair and delivery of bottled gas.

Contractor shall supply and install all facilities at this site which shall include, but not necessarily be limited to, the following: prefabricated equipment building; prefabricated generator housing; foundations for buildings, tower and guy anchors; antenna support; equipment; helicopter pad; generators; gas storage tanks (two sets); and all miscellaneous wire, hardware and racks.

This site is to be secured for use by the University of Arizona Medical Center under an agreement with the Papago Tribe. Contractor shall lend all assistance as requested in this regard.

#### 7.2.10 Kitt Peak

This site is to be secured for use by University of Arizona Medical Center by way of a joint site agreement with Kitt Peak Observatory. The Contractor shall assist, as requested, in developing this agreement. Contractor shall coordinate all work on Kitt Peak with the Observatory's agent and the Project Director. Electrical power is to be supplied via an adjacent transformer pad. Contractor is to use all buried wire in accordance with the Observatory's policy. Power cross connect shall be at a point as designated by the Observatory. The site will require installation of a prefabricated equipment shelter and tower. No fence is permitted.

#### 7.2.11 Pisinimo

In addition to the mobile health unit/telemedicine facility, which is discussed elsewhere, there will be required at Pisinimo a fixed relay site. This site shall house the microwave equipment, a VHF radio link and the command and control system associated with the steerable 2-foot dish. The tower must be of a type that provides a catwalk at approximately 4 feet below its top. The tower, a self-supporting type, shall be capable of supporting the microwave antennas, the VHF antenna and the weather tight motor drive unit associated with the steerable antenna.

Commercial power is available. A stand-by generator and prefabricated equipment shelter is required.

#### 7.2.12 San Xavier

This remotely switched relay site is situated near the Indian Health Service's Health Program Systems Center (HPSC). It shall be the terminal for all teleprinter circuits and conditioned for further transmission by common carrier telephone dedicated landline circuits to the Bell Aerospace computer approximately two miles distant. It shall be the Contractor's responsibility to arrange for these leased lines. All charges for the leased line installation and rental will be borne directly by the Arizona TeleMedicine Project. The Contractor shall provide and install all interface equipment external to the computer center facility. Contractor shall coordinate all activity related to ensuring that the teleprinter service is provided to all Phase I sites in a timely and complete manner.

The San Xavier site shall also be arranged so as to provide monitor service (program audio and video, one simplex channel) to HPSC. Selection of the input to this monitor circuit shall be under the control of the class "c" station at the University of Arizona Medical Center. The monitor circuit, aerial cable, modulator, color monitor, audio equipment, buried cable and all miscellaneous equipment and installation tasks including securing the pole attachment agreement on

the Network's behalf shall be the responsibility of the Contractor. Cost of the attachment agreement is the direct responsibility of the Arizona TeleMedicine Project.

A prefabricated equipment shelter, tower, fence and locked gate shall be the responsibility of the Contractor to provide and install.

Commercial electric power is nearby. Cost of installation of commercial power at this site as well as at all other "new power tap sites" shall be the responsibility of the Contractor. Battery stand-by is required here; eight hour reserve shall be provided by the Contractor.

#### **7.2.13 Santa Rosa**

Equipment space is available. A tower is required. Stand-by power to run both the radio equipment and the clinical facilities in the emergency room shall be provided by the Contractor.

#### **7.2.14 Phoenix**

Equipment space is not available in the penthouse at the Phoenix Indiana Medical Center. Contractor shall provide a prefabricated equipment shelter on the roof immediately adjacent to the penthouse and inside the decorative screen. Stand-by power and room temperature air is available at this level on the building. Contractor's responsibility shall include the sheet metal work involved in channeling the air through the equipment shelter. The conduit and power wiring from within the penthouse to the equipment shelter is also the responsibility of the Contractor.

A 10-foot stub tower is required on the penthouse roof. Any necessary relocation of the existing television and VHF radio antennas or their support structures shall be the Contractor's responsibility. Restoration of any interruption in these services as may be caused by the Contractor in the course of his work shall be prompt.

#### **7.2.15 Prefabricated Shelters**

Where called for, the prefabricated equipment shelters shall include as part of the shelter "package" the following items and specifications. The exception is at Phoenix Indian Medical Center Hospital. Here, exhaust air from the hospital shall be utilized for circulation through the shelter in lieu of the self-contained heating and/or cooling devices at most other sites. Also a foundation is not called for; instead steel skids will bear the load.

Except where noted, the following requirements shall apply at each site where equipment shelters are needed. Also, except where noted, all items are the Contractor's sole responsibility.

a. Building shall rest on a reinforced concrete slab as shall be provided by the Contractor. Footings shall extend at least 24 inches below grade and in no case less than the depth recommended as a result of the test boring done in connection with this project.

b. The structure shall be bolted to the slab using at least six 3/8-inch threaded rods and hardware as installed when the concrete is poured.

c. The equipment housing shall be designed to maintain inside temperatures within the recommended equipment operating ranges for all normal outside ambients. The Contractor may use electric heaters, forced or natural ventilation, standard or reverse cycle air conditioning as required. He may if appropriate, incorporate features such as weather insulation and ventilated double roofs in the building design. If forced or natural ventilation is used as a principal means of cooling, dust filters or precipitators must be included in the ventilation system. Batteries shall not be located in normally unventilated spaces, but may be located in ventilated spaces partitioned off from air-conditioned radio equipment rooms.

d. Electric power wiring shall be provided for all Contractor installed equipment (including heaters, air-conditioners, vent fans, etc.) and for common carrier connecting arrangements requiring installation at San Xavier. In addition, he shall provide a ceiling mounted receptacle for a 150-watt incandescent lamp and two standard double wall outlets for test equipment and small electric tools for each 100 square feet of floor space. The ceiling lamps shall be controlled by switches near the building entrance.

### 7.3 Towers, Antennas and Radomes

#### 7.3.1 Tower and Support Structures

The Contractor shall supply and install steel towers and antenna support structures as required at all sites except where existing structures may be used. Tower and foundation designs shall comply with EIA Standard RS-222A, with specific allowance made for the wind and ice conditions prevailing at each site. The design of each tower or antenna support structure employed in the system shall include an allowance for the future addition of up to two 8-foot parabolic antennas mounted at any reasonable height and pointed in any direction, such antennas to be included in the wind load calculations made under RS-222A. Contractor responsibility shall include

the installation of tower foundations and guy anchors. In the case of roof top antenna support, the Contractor shall provide any required strengthening or reinforcement of roof members. Contractor shall provide a suitable ice shield to prevent falling ice damage to the BIA building in Pinal Peak. This shield shall at minimum consist of a 10- by 10-foot grid of 1/2-inch cold rolled steel stock framed by 1-inch steel angles. The grid spacing shall be no greater than 10 inches square.

Figures D.51 through D.62 are sketches of the proposed towers required in Phase I of the Arizona TeleMedicine Network.

### **7.3.2 Test Boring**

Test borings to determine the soil bearing pressure capacity where towers and other structures are to be placed may be done at each site where good practice indicates or suggests it. Test borings at Kitt Peak, Pinal Peak and Bylas are a requirement under these specifications unless such data may be acquired from the test boring procedures carried out by others within the past five years. The Contractor shall submit certified copies of all test data to the Project Director for his approval prior to construction at these sites.

### **7.3.3 Tower Lighting and Marking**

If required by Federal Aviation Regulations, Part 77 and FCC Rules and Regulations Part 17, the towers and antenna support structures shall be lighted and marked in accordance with FAA AC 70/7560-1A. A photoelectric device meeting the requirements of Section 13.6(1) of AC 70/7560-1A shall be provided for turning the tower lights on and off.

### **7.3.4 Removal of Old Tower and Relocation of Existing Antennas**

After completion of the new tower at Pinal Peak, the Contractor shall move existing mobile radio base station antennas from the old to the new tower (or install replacement antennas) and shall disassemble the old tower and dispose of it in accordance with the instructions to be provided by the San Carlos BIA. This task shall include installing and fastening the RF transmission lines associated with the mobile radio antennas. The Contractor shall supply all new materials, including mobile radio base station antennas, antenna mounting hardware, RF transmission lines and hangers.

### **7.3.5 Microwave Antennas**

Antenna mechanical characteristics shall comply with EIA Standard 195A. Unless the Contractor's calculations indicate that larger antenna and higher gains are required to meet the

performance specifications of the system as set forth in this document, the antenna positioning and sizes shall be as specified on Figures D.51 through D.62.

**7.3.6 Radomes**

Unheated radomes shall be installed at each site and on each microwave antenna.

**7.3.7 Reflectors**

To provide reliable microwave paths for the links indicated below, intermediate passive reflectors shall be required. Minimum reflector size is listed for each link. Installations shall be in accordance with EIA specified in RS-195 A, "Electrical and Mechanical Characteristics for Microwave Relay System Antennas and Passive Reflectors."

<u>Link</u>	<u>Reflector Size (feet)</u>
Bylas Clinic – Pinal Peak	30 X 32
Santa Rosa – Kitt Peak	24 X 30

**7.3.8 Transmission Line**

Microwave transmission line mechanical characteristics shall comply with EIA Standard RS-158. The lines shall be pressurized with dry nitrogen. All storage tanks, fittings, tubing, regulators, valves shall be provided as needed at each site. At the Cimarron Peak site only, the Contractor may elect to install as an alternate form of pressurization, an electrically driven air pump with a visible type dehydrator.

**7.3.9 Grounding**

All support structures, towers and radio equipment main frames shall be grounded in accordance with recognized industry practice. The following guidelines shall prevail as minimum specifications.

South Mountain Use station ground for equipment rack grounding. Strap with 6 AWG copper.

Phoenix }  
Medical Center } Bond the stub tower base and equipment main frames to the lightning rod ground system using 2 – 0 stranded copper

Pinal Peak }  
San Carlos } Drive one 3/4-inch X 10-foot copper clad grounding rod at the base of each tower  
Bylas } leg. Bond tower base, ground rods and equipment racks together using 2 – 0  
Mt. Lemmon } stranded copper.  
San Xavier }  
Santa Rosa }  
Sells }  
Pisinimo }

University of }  
Arizona } Bond the tripod support structure, using 2 – 0 stranded copper, to the lightning  
Medical Center } rod ground system. Use existing Penthouse ground network for equipment rack  
grounding. Bond with 6 AWG copper.

#### 7.4 Chain Link Fencing

Contractor shall provide fencing to enclose, at Pisinimo and San Xavier, both the towers and equipment buildings (approximately 12 foot X 24 foot). A single swing gate shall be provided with combination lock at each site.

Standard mill tolerances shall be used for all framework members and chain link fabric.

The total height of fence shall be six feet above grade when erected.

The fence shall be aluminum coated steel chain link 72 inches high, 0.148-inch wire woven in a 2-inch mesh. Top and bottom salvage to be twisted and barbed.

Fence posts and posts for swing gate shall be standard weight 2 1/2-inch pipe.

All posts shall be equipped with tops so designed to exclude moisture from the posts.

Posts shall be evenly spaced in the line of fence no farther apart than 8 feet on center.

The posts shall be of sufficient length to extend 24 inches into concrete footings.

## 7.5 Equipment Failure Alarms

Two master alarm centers (Phoenix equipment shelter and Tucson penthouse) shall be provided. Each alarm center shall present the following information regarding the status of stations under its coverage area.

- a. Three dB or greater drop in the power of any basic system microwave transmitter
- b. Any basic system transmitter off more than  $\pm 0.02$  percent in frequency
- c. Loss of received signal on any basic system microwave receiver as indicated by the AGC
- d. Complete failure of a multiplex group
- e. Failure of primary ac power (operation on batteries or stand-by power generator)
- f. Failure of top tower light (if required)

Any alarm produced at the master alarm center readout panel shall cause a flashing light and buzzer indication on the control console located several floors below. The function of this indicator is to summon a maintenance technician to the roof top radio room. Further information as to the site involved or nature of the trouble can be ascertained upon inspection of the master alarm panel.

The master alarm center at Phoenix shall provide readouts for Cimarron, South Mountain, Phoenix (local), and Pinal Peak. All other sites shall be reported at the Tucson master alarm center.

## 7.6 Order Wire

A single channel order wire system shall be provided for each of the master alarm centers. The order wire will interconnect with the other center and each center with each microwave station for which it has responsibility. A selective calling system shall be employed so that a person at any microwave station may audibly signal a person at any other microwave station in the same maintenance area.



Order wires shall have a nominal bandwidth of 300 to 3,000 kHz and under unfaded microwave conditions, shall have a 1,000 Hz test signal to rms noise ratio (unweighted) of not less than 35 dB.

#### **7.7 Frequency Shift Key Equipment**

Six channels of FSK control equipment shall be supplied in a full duplex configuration at each terminal site (class "a," "b" and "c" stations). These circuits shall provide remote control of the following dc switches: camera tilt, camera pan, lens zoom, lens focus, lens iris and monochrome bypass.

#### **7.8 Lighting**

Two 500-watt quartz lamp fixtures (each with spare lamp) shall be provided and installed at each terminal site. Frosted lamps and diffusers shall be used so as to reduce glare. The fixtures shall be controlled from the console with separate on/off switches for each. The fixtures shall be ceiling mounted and shall be capable of being directed toward any point in the room (manual adjustment).

#### **7.9 System Maintenance Manual and Operation Manual**

Fifteen copies of a system maintenance manual shall be delivered prior to the completion of system installation and before any equipment is operated in the field. The maintenance manual shall describe the system and shall cover all routine periodic inspection, testing, alignment, adjustments, fault location and any other maintenance procedures. Test equipment and tools required for system maintenance shall be called out. Periodic maintenance schedules and recommended formats for recording maintenance data shall be included. The maintenance manual shall be directed to persons who have no initial familiarity with the system but who are otherwise qualified engineers and electronic technicians. The manuals shall include detailed plant-in-place drawings for each site. Five Operation Manuals shall be provided at each network terminal site. These manuals shall be directed to nontechnical personnel and shall be explicit in use of the operator equipment. Contractor is advised that some individuals to whom the manual is directed have no background in communications or electronics. The Project Director will regard the production of these manuals as a major task item.

#### **7.10 Unit Instruction Manuals**

Fifteen sets of unit instruction manuals shall be supplied for each type of unit and major subassembly used in the system. Each unit instruction manual shall include but not be limited to a description of the unit's function, a block and schematic circuit diagram of the unit, a

step-by-step explanation of the circuit diagram, tests and troubleshooting techniques, alignment, and repair procedures. Test equipment and tools required for maintenance and repair of the unit shall be called out. The unit instruction manuals shall supplement and may be referenced by the system maintenance manuals.

## 7.11 Test Equipment

The following list of test equipment will be provided by the Contractor and delivered in good working order at each of the two network sites designated as "Maintenance Centers." These two sites, in Phase I of the network are: The University of Arizona Medical Center (Tucson) and the Phoenix Indian Health Service Hospital.

2 ea. Triplett Type 630 <sup>1</sup>	Multimeter
1 ea. Hewlett-Packard Type 414A	Auto-Voltmeter
1 ea. Systron-Donner Model 6057	Counter
1 ea. Hewlett-Packard Type 478A	Thermistor Mount
1 ea. Hewlett-Packard Type P932A	Mixer
1 ea. Hewlett-Packard Type 431B	Power Meter
1 ea. Hewlett-Packard Type 400EL	AC VTVM
1 ea. General Radio Type 1304B	Oscillator
1 ea. Hewlett-Packard Type 400EL	Accessories
1 ea. Telechrome 3538	Video Test Set, including all available plug-in modules
1 ea. G.E. Type EX08A	Test Set
1 ea. Hewlett-Packard Type 651	Video Oscillator
1 ea. Tektronix Type 453	TV Oscilloscope
1 ea. 12-inch Trinitron Color Television Monitor (SECAM/NTSC)	
2 ea. 9-inch Monochrome Television Monitors	
1 set, test cords, connectors and miscellaneous adapter and tuning tools	

<sup>1</sup>Use of brand names is purely for descriptive purposes "... or equivalent" is to be implied.

In addition to the above, four sets of hand tool kits shall be provided to the Project Director for distribution and assignment to his technical staff. These kits shall be equal to or better than the JTK-27 kit (without instruments) produced by Jensen Tools and Alloys, Phoenix, Arizona.

#### 7.12 Spare Equipment and Materials Requirement

The Contractor shall, as part of his construction contract, supply the following list of spare parts, components, panels, equipment and material. Delivery shall be to the site or sites as stipulated by the Project Director. Delivery shall be effected prior to final acceptance.

2 sets	matched 1-inch camera tube replacements
1 each	color monitor (type as supplied at each site)
1 each	monochrome monitor, large (type as supplied at each site)
1 each	twin small monochrome monitors, (type as supplied in each console)
1 each	audio logging recorder (type as supplied in each console)
1 each	video logging recorder (type as supplied in each console)
2 each	video DA modules (type as supplied in each console)
2 each	video DA power supply (type as supplied in each console)
1 each	audio mixer and limiter (type as supplied in each console)
1 set	modules for multiplex equipment (12 channels)
1 set	common equipment modules, panels and circuit boards (not channel dependent) for microwave radio equipment for both 6 GHz and 12 GHz units
4 each	video switcher modules
4 each	audio frequency switcher modules
1 set	telemetry equipment modules
4 boxes	fuses of all types

### **7.13 Path Engineering**

The Contractor shall assure that all microwave hops are designed for both a path clearance of at least 0.3 of the first Fresnel zone at an equivalent earth radius factor of 2/3. Microwave hops for those links using frequencies above 10 GHz shall not exceed 21 miles.

### **7.14 Fade Margin**

Each microwave hop shall have a fade margin of 40 dB above the RF signal level. The Contractor shall specify his transmitter powers, receiver noise figures, antenna sizes and other system parameters to achieve this margin.

### **7.15 Stand-by Electric Power**

#### **7.15.1 General**

The microwave sites selected for Phase I of the Arizona TeleMedicine Network for the most part are situated near reliable sources of power. Hospital stand-by circuits shall be used where available. At each site, Contractor shall provide Sola regulated transformers in each incoming ac line including those ac lines carrying self-generated power. Lightning arrestors shall also be provided in each ac line.

For Cimarron Peak which has no available commercial power, a dual power generator system shall be provided.

The Contractor shall provide a single generator set at each of the following sites:

- a. Pisinimo mobile unit (carried on board, no load transfer panel required)
- b. Pisinimo relay site
- c. Pinal Peak (sufficient capacity to handle both the Network's equipment and the existing BIA equipment which consists of two VHF repeaters)
- d. Santa Rosa (sufficient capacity to operate all Emergency Room facilities and lights as well as the Network equipment)

The Contractor shall supply storage batteries at San Xavier and at the KAET, South Mountain, site with sufficient capacity to operate the radio and multiplex equipment, for an uninterrupted period of eight (8) hours after a primary power failure. The batteries shall be floated

across the dc power bus such that the charge will normally be maintained by the equipment dc power source, and on failure of primary power, will provide uninterrupted power to the equipment.

#### 7.15.2 Generator Equipment Specifications

The Contractor shall supply and install electric generator sets of not less than 5 kW capacity for providing primary and/or auxiliary power to the microwave sites, as appropriate. The minimum requirements shall comply with EIA Standard RS-173 as modified by the following notes: Contractor is advised that the Project Director may wish to consider propane gas/thermoelectric generating plants as an alternative to the engine generator plants. Contractor will seek the Project Director's approval before purchasing electric generating plants for the Network. Should the Project Director decide to use this alternative, a change order will be issued.

- a. The engine shall be a "spark ignition engine" as covered by Section 2.1 of RS-173.
- b. The engine will be adapted to use propane gas as a fuel. Fuel tank capacity shall be adequate for at least 30 days (primary) or 48 hours (stand-by) of operation under full load.
- c. Electrical characteristics shall be 120/240 volt, 30 amp., single-phase, 3-wire.
- d. The starting battery shall be provided with a trickle charger that can be operated by connection to 115-volt ac commercial power (where available) when the engine is not operating.
- e. Where commercial power is available, an automatic load transfer panel shall be provided to transfer load to the engine generator set within 15 seconds after a commercial power failure.
- f. Where commercial power is not available and two engine generator sets are provided, an automatic load transfer panel shall be provided. The load transfer panel shall transfer load from which ever unit had been functioning as the primary source (and failed) to the stand-by unit. Transfer must not require more than 15 seconds after primary source failure.
- g. All generator sets shall be mounted on reinforced concrete pads and (where applicable) properly housed to prevent weather damage. A firebrick wall shall separate the gas tanks from the generator set.

- h. A weather protective housing shall be provided for the generator(s) and associated switching equipment.
- i. Accessories shall include line voltmeter, line ammeter, running time meter and ac frequency meter. A set of recommended maintenance tools shall be provided with each engine generator set.

**7.16 Facilities, Equipment, Services to be Supplied  
by the Contractor**

The Contractor shall furnish all necessary materials, equipment and labor to install and test the system as specified herein. This will include antennas, supporting structures, transmission lines, equipment housing, radio equipment, base band equipment, carrier and multiplex equipment, rectifiers, batteries, emergency power equipment, test equipment spare parts, hardware, mobile unit clinical equipment and all other related ancillary equipment as required. The Contractor shall provide all required vehicles, tools and machinery necessary for constructions, and all test equipment required for performing electrical testing specified herein. The Contractor will be responsible for all necessary transportation, lodging and subsistence of Contractor personnel. The Contractor shall be responsible for compliance with all Federal, State and local laws including requirements for local building permits. However, the Arizona TeleMedicine Network will provide such assistance in these matters as is reasonable and appropriate.

## 8.0 QUALITY ASSURANCE

### 8.1 Acceptance Test Plan

Not less than 12 weeks before construction is complete, the Contractor shall submit his acceptance test plan to the Project Director for his review, comment and approval or rejection. Following completion of the project construction work and approval by the Project Director of the acceptance test plan, testing may be started.

### 8.2 Test Procedure and Schedule

The Contractor shall conduct all inspections and tests required to demonstrate compliance with the requirements of the specifications and according to the test plan (Section 5.1) prior to acceptance of the system by the Network. He shall supply all equipment, material and labor for such inspections and tests. Tests shall be conducted in accordance with an approved test procedure. The Project Director or his designated representative shall be notified 2 weeks in advance of the commencement of any series of tests and shall be provided an opportunity to witness such tests. However, the failure of the Project Director to provide a witness after notification shall not be a cause for delay in testing. The Contractor shall provide the Project Director with a copy of all acceptance test data.

### 8.3 Tests at the Factory

Quality control tests shall be performed at the factory on all major components of the system to assure that performance meets the manufacturer's specifications, particularly with respect to those parameters (such as transmitter power, receiver noise figure, etc.) having a direct bearing on system performance. The Contractor shall cause records of such tests to be maintained for at least one year following final acceptance of the system by the Network, and upon request, he shall furnish copies of the test records to the Project Director. All facilities and test equipment required for these tests shall be furnished by the Contractor.

### 8.4 Preliminary Alignment and Test

The Contractor shall perform all preliminary alignments, adjustment and performance checks prior to the beginning of final acceptance testing. After commencement of acceptance testing, only those adjustments prescribed in the published maintenance material supplied by the Contractor shall normally be made on the equipment, and these shall not be made

more often than the prescribed intervals. No other adjustments, corrections or equipment modifications shall be made without the concurrence of the Project Director or his designated representative, who will determine whether or not previously taken data requires repeating.

#### **8.5 Site Inspection and Measurements**

Each site, including the mobile unit shall be carefully inspected, preferably by a team having both Network and Contractor representation. The inspection shall include the antennas and support structures, housing and equipment. In addition, the following measurements shall be made at each individual microwave site prior to tests on the system as a whole.

- a. Power supply voltages
- b. Power consumption
- c. Transmitter frequency
- d. Transmitter output power
- e. Receiver noise performance
- f. Voice channel test signal output level
- g. Multiplex HF output level
- h. Multiplex intrinsic noise level at voice channel output
- i. All alarm functions
- j. Generator and load transfer panel operation



## 9.0 GENERAL CONDITIONS AND INSTRUCTIONS TO CONTRACTOR

### 9.1 Definitions

The following terms or abbreviations thereof used throughout this document and the proposed contract shall have the meanings herein defined:

1. **Project Director**                    The designated individual who acts for the University of Arizona Medical Center and/or the Arizona TeleMedicine Network. The term may also refer to the Project Director's authorized agent.
2. **Contractor**                        The designated party or authorized agent acting for the organization responsible for the execution of all works specified in this document.
3. **Network**                            The Arizona TeleMedicine Network and/or the University of Arizona.

### 9.2 Total System Responsibility

It is intended that a single "turn key" contractor shall assume total responsibility for Phase I of the Arizona TeleMedicine Network construction. Such responsibility shall include, but not be limited to, the following hardware items:

- o        Communications system as defined
- o        Terminal site equipment
- o        Consoles
- o        Prefabricated shelters
- o        Towers
- o        Fences
- o        Telephone Company interface



- Slow-scan TV units
- X ray machine where indicated
- Laboratory equipment
- Mobile TeleMedicine unit
- Furniture and examination room fixtures where indicated
- Telemetry equipment
- Sensors and display devices
- Teleprinters.

tasks: Furthermore, the Contractor's service responsibility shall include the following

- Test borings and civil engineering to assure soundness of footings for towers and buildings provided as part of this project
- Frequency search and license application preparation
- Legal service through an attorney familiar by experience with radio law. Such service shall be limited to initial filing and followup and shall not include hearing representation should conflicts develop
- Technical assistance to the Project Director in matters relative to land use for network sites.
- Preparation and filing of U.S. Forest Service Special Use Applications
- Installation and test of all hardware, cable and wire as described in these specifications
- Final system performance testing

- o Identification and resolution of all interface parameters between his and associated equipment and facilities.

### **9.3 Completeness of System**

The Contractor's overall responsibility shall be to provide a whole and complete system to the satisfaction and in the judgment of the Project Director.

### **9.4 Qualifications of Contractor and his Proposed Vendors**

1. Except as otherwise specified, all basic equipment categories described herein shall be the product of manufacturers who shall have produced similar apparatus for the past 5 years or who shall supply a list of accounts and their installations now rendering satisfactory service. The equipment supplied by the manufacturer must equal or exceed the specified performance characteristics and quality. The manufacturer's performance data and drawings must be submitted for approval to the Project Director prior to its purchase.

2. The microwave equipment and camera manufacturers shall maintain service organizations capable of supplying on-call service, or yearly service contracts. This service shall be available to the user only when contracted for separately. The manufacturer must have the organizational capability and geographic field setup to provide needed service and spare parts within 24 hours.

### **9.5 Materials and Employees**

1. Unless otherwise specified, all materials shall be new. Both workmanship and materials shall be of the best quality.

2. The Project Director shall have authority to order discharged, and removed from the Network project, any employee of any Contractor who shall be found incompetent or in any way detrimental to the best interest of the work.

### **9.6 Superintendent, Supervision**

The Contractor shall provide, during its progress, a competent superintendent and any necessary assistants, all subject to the approval of the Project Director. During the course of construction and until final acceptance, the Contractor shall maintain a Tucson office and/or a

Phoenix office, staffed during normal business hours. The superintendent and local office manager shall represent the Contractor in his absence and all directions given to him shall be as binding as if given to the Contractor. Important directions shall be confirmed in writing to the Contractor. Other directions shall be so confirmed on written request in each case.

The Contractor shall give efficient supervision to the work, using his best skill and attention.

Immediately after the award of the Contract, the Contractor shall submit an outline experience record of his intended Project Superintendent in order that the Project Director may review his qualifications. The Project Director will notify the Contractor of his approval or disapproval. Until completion and acceptance of the work, the Contractor shall not change or remove the approved superintendent except with the consent of the Project Director.

The Superintendent shall represent the Contractor in his absence and all directions given to him shall be as binding as if given to the Contractor. Important directions shall be confirmed in writing to the Contractor. Other directions shall be so confirmed on written request in each case. The Project Director shall not be responsible for the acts or omissions of the Superintendent.

The Contractor shall maintain order and discipline among the workmen at all times.

#### **9.7 Preconstruction Submission of Drawings**

1. Two copies of all construction, floor plan and shop drawings, shall be submitted to the Project Director for approval before ordering the items or starting the work involved.

2. All drawings submitted shall bear the stamp of approval of the Contractor submitting same as evidence that they have been checked by him. Correction of specifications and locations of various items, or variations from the requirements of the Contract Documents shall be made or corrected by the Contractor at the request of the Project Director.

3. If the drawings show variations from the requirements of the Contract Documents because of recognized standard practice, or any other reason, the Contractor shall make specific mention of such variation in his letter of transmittal.

4. Where field measurements are required or necessary they shall be made, when possible, before preparation of drawings, and noted as such on drawings.

5. The approval of these submissions by the Project Director will be general and shall be understood to mean that the Project Director has no objection to use of materials or processes shown. This approval shall not relieve the Contractor of responsibility for errors, omissions or deviations from the contract requirements.

Notwithstanding the provisions of these specifications with respect to indicated types and prior utilization requirements, the Contractor shall have the right to propose nonconforming equipment or systems on the condition that the bidder shall acknowledge such factors and shall supply pertinent information concerning the reasons for his choice(s).

#### **9.8 Subcontract (Consultants, Suppliers, etc.)**

The Contractor shall notify the Project Director in writing of the names of subcontractors (suppliers, engineers, riggers, lawyers and consultants) proposed for the work, and shall not employ any subcontractor without the prior written approval of the Project Director.

The Contractor agrees that he is as fully responsible to the Project Director for the acts and omissions of his subcontractors and of persons either directly or indirectly employed by them, as he is for the acts and omissions of persons directly employed by him.

#### **9.9 Relations of Contractor and Subcontractor**

The Contractor agrees to bind every subcontractor and every subcontractor agrees to be bound by the terms of the Agreement.

#### **9.10 Changes in the Work**

The Project Director, without invalidating the Contract, may order, in writing, extra work or make changes by altering, adding to or deducting from the work, the Contract Sum being adjusted accordingly. All such work shall be executed under the conditions of the original contract except that any claim for extension of time caused thereby shall be adjusted at the time of ordering such change.

In giving instructions, accepting and rejecting portions of the work, the Project Director shall have the authority to make minor changes in the work, not involving extra cost, and not inconsistent with the purpose of work.

**9.11 Licenses, Permits, Taxes and Wages**

Except for FCC application fees, building additions and other items specifically exempted in the Specifications, the Contractor shall pay for all licenses, permits, taxes and fees required for this project; and shall comply with all laws, ordinances, regulations, and other requirements applicable to the work specified.

**9.12 Property Damage**

All property shall be protected against damage by the Contractor which might occur by reason of his operations in the performance of the contract.

**9.13 Scheduling**

The scheduling of any work on tribal, private or Government owned premises, buildings or property must be coordinated with the owner or other person in responsible charge in order to minimize the disturbance of activities normally conducted on the premises.

**9.14 Final Cleanup**

Upon completion of the work, the Contractor shall reconnect any utilities, equipment or appliances removed in the course of work, and replace all fences, etc., moved for the performance of work. Debris and rubbish caused by the work shall be removed and the premises left clean.

**9.15 Performance Bond**

The Contractor must furnish a performance and payment bond for 100 percent of the total of the contract at the Contractor's expense. This bond shall be in the form of a Surety Bond by a responsible surety company satisfactory in the opinion of the Project Director, guaranteeing the faithful performance of and payment for the work detailed in request for proposal. Bond shall be provided prior to commencing work and shall remain in force for the duration of the contract.

**9.16 Contract Schedule**

The Contractor shall begin work not later than 30 days after the award of the contract. All work shall be complete within 12 months thereafter.

**9.17 Workmen's Compensation and Liability Insurance**

The Contractor shall maintain during the term of this contract the following insurance:

- a. Workmen's Compensation and employer's liability insurance as required by statute.
- b. Public liability insurance in amounts not less than \$100,000 per person and \$300,000 per accident for bodily injury, and \$25,000 per accident for property damage, including products on completed operation coverage.
- c. Automobile liability insurance covering all owned, nonowned and hired vehicles in amounts as indicated in Subparagraph (b) above.
- d. Contractual liability insurance covering all liability arising out of the terms of this agreement.

The insurance coverage required shall include those classifications as listed in Standard Liability Insurance Manual, which most nearly reflect the operations of the Contractor. All insurance policies shall be issued on companies authorized to do business under the laws of the State of Arizona.

The Contractor shall furnish certificates of insurance to the Project Director prior to the commencement of operations, which certificates shall clearly indicate that the Contractor has obtained insurance in the type, amount and classifications as required for strict compliance with this paragraph and that no material change or cancellation of the insurance shall be effective without 30 days prior written notice to the Project Director.

Compliance with the foregoing requirements shall not relieve the Contractor of his liability and obligations under this Section or under any other portion of this contract.

**9.18 Guarantee**

The Contractor shall guarantee his workmanship and materials for a period of 1 year from the date of acceptance by the Arizona TeleMedicine Network. Should defects develop within the guarantee period, the Contractor shall, upon written notice of same, remedy the defects and reimburse the Network for all damage to other physical plant components, whether caused by the

defects or the work of correcting same. The Performance Bond furnished by the Contractor as a part of this contract shall remain in effect until the expiration of the guarantee period as assurance of the Contractor's obligation to meet the guarantee.

**9.19 Prosecution of the Work**

It shall be the duty of the Contractor to notify the various Subcontractors when their presence is required on the job, expedite the flow of materials and secure all necessary inspections. The Contractor shall give reasonable notice to the Project Director when his presence is required for special consultations, examinations or decisions.

**9.20 Protection of Materials**

Any materials delivered to the job in finished condition, installed in finished condition, or installed and finished before completion of the work, shall be protected from damage until acceptance of the work. Prefinished materials which are damaged either before or after installation, shall be refinished.

**9.21 Workmanship**

All work shall be executed only by installers, technicians, artisans and mechanics qualified, through experience, in their respective branches and only persons of such qualifications will be permitted to perform the work involved. It shall be understood that work installed contrary to the Specifications or as judged unacceptable by the Project Director shall be removed and replaced without delay, when so directed by the Project Director.

**9.22 Care of the Work**

The Contractor shall have charge of the equipment and work under construction until the completion and final acceptance of the work under the contract.

The Contractor shall be responsible for all injury to work in progress of construction, and for all property or materials stored on the premises that may be injured or stolen while the work is in his care, and he shall make good all such damage or loss without expense to the Arizona TeleMedicine Network.



**9.23 Arbitration**

Any controversy or claim arising out of or relating to this contract shall be settled in accordance with the Rules of the American Arbitration Association, which said rules are hereby adopted by reference as much as if incorporated fully herein.

**9.24 Testing**

All testing of complete work, as required in the specifications, shall be furnished by the Contractor, and the cost of such testing shall be included in his total project price.

**9.25 Safety and Protection**

The Contractor shall take all necessary precautions for the safety of employees on the work, and shall comply with all applicable provisions of Federal, State, and Municipal Safety laws and building codes to prevent accidents or injury to persons on, about or adjacent to the premises where the work is being performed. The Contractor's job superintendent shall be responsible for the prevention of accidents during construction. The Contractor shall comply with all applicable provisions of the "Manual of Accident Prevention in Construction" of the Associated General Contractors of America, Inc.

**9.26 Completion and Acceptance**

1. When the Contractor is satisfied that all work required by plans and specifications of the Contract has been completed, he shall notify the Project Director. The Contractor will be notified immediately as to acceptance or rejection of his notification.

2. Upon acceptance of this notification, the Project Director and his Agents will conduct a final inspection to determine what items remain in an unacceptable condition. A report of this inspection will be delivered to the Contractor within 15 days (working days) following acceptance of the Contractor's letter of completion.

3. Upon receipt of this list of unacceptable items, the Contractor shall take immediate corrective action on all items. When all items on list have been corrected satisfactorily, the construction will be formally accepted by the Project Director in a "letter of acceptance." Final payment will then be processed.

**9.27 Like Items of Same Manufacturer**

For economy of maintenance, all like items (such as all 12-GHz radio equipment) shall be of the same manufacturer.

**9.28 Experience**

The Contractor shall have successfully completed the engineering design of at least two other medical or educational networks or systems of similar scope within the past two years.

The Contractor shall, within the past two years, have been selected as prime contractor in the supply and installation of at least one other multiple station television microwave network using remote control switching.

The Contractor shall document the applicable experience as defined above and submit same as may be requested by the Project Director.

**9.29 Discrimination**

All Federal and State statutes as to discrimination in employment practices shall apply.

**9.30 Environmental Protection**

The Contractor shall ensure compliance with all Federal and State requirements regarding environmental impact.

**9.31 Training**

The Contractor shall provide training in equipment repair and operation for 15 persons to be designated by the Project Director. The training will be conducted at the Network's facilities and is to consist of not less than 10 days training in the radio equipment, and not less than 10 days in multiplex console and carrier equipment. The training is to be scheduled at a mutually agreeable time, but before system acceptance tests. Costs of transportation, lodging and subsistence of the persons in training will be borne by the Network. Contractor is advised that the Project Director regards this training as a major task item and of vital concern. Furthermore, the Contractor is to structure his training material for group with varying educational backgrounds.

## APPENDIX A

### PATH PROFILE

Note: When towers are not specified on the Vertical Earth Profiles, only minimum tower heights governed by antenna size, will be required.

Note: Corrections for earth curvature and Fresnel zone radius have been included on each profile:

$\wedge$  0.3 first Fresnel zone radius

$\Delta$  earth curvature for  $k = 2/3$

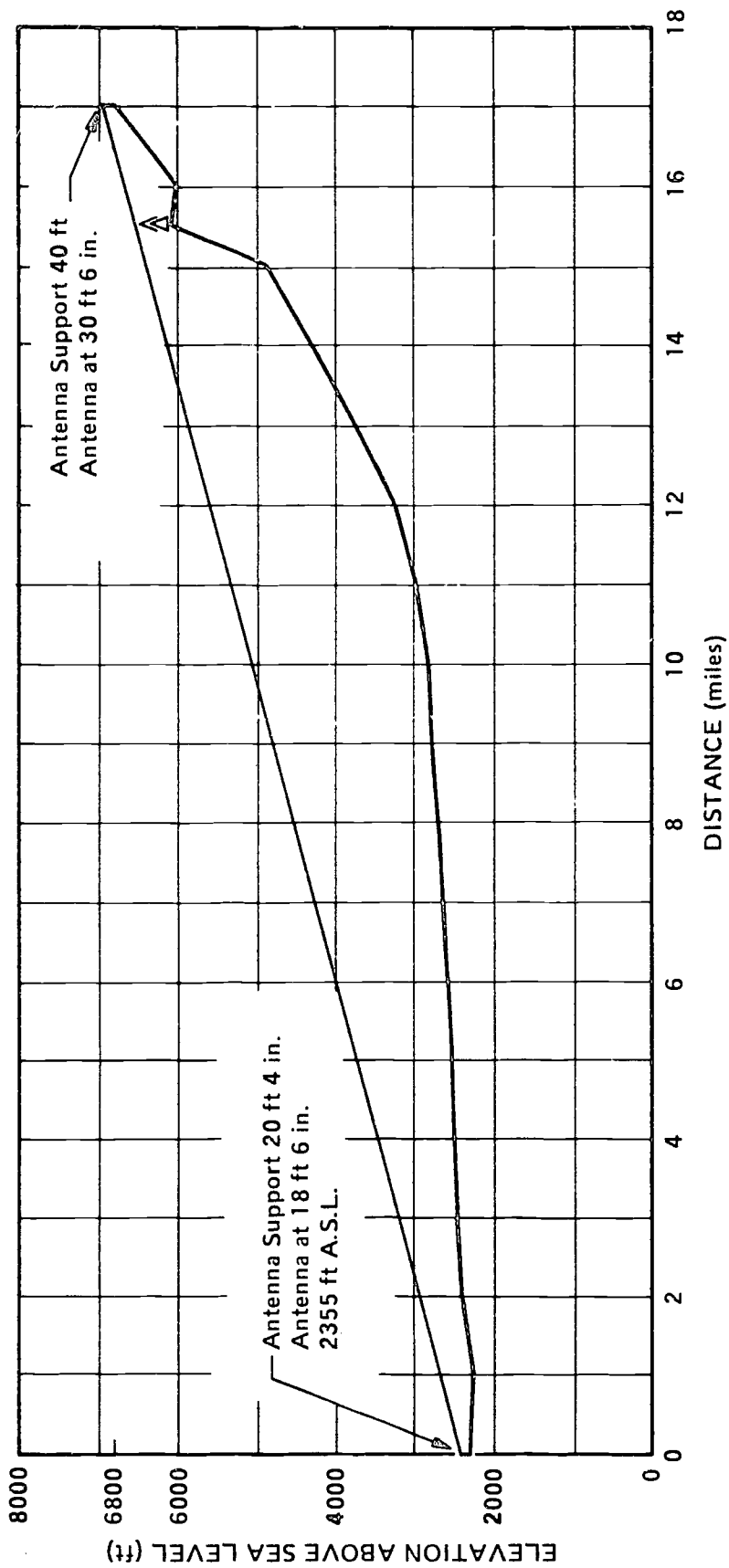

Figure A.1. Microwave Path Profile, Sells to Kitt Peak.

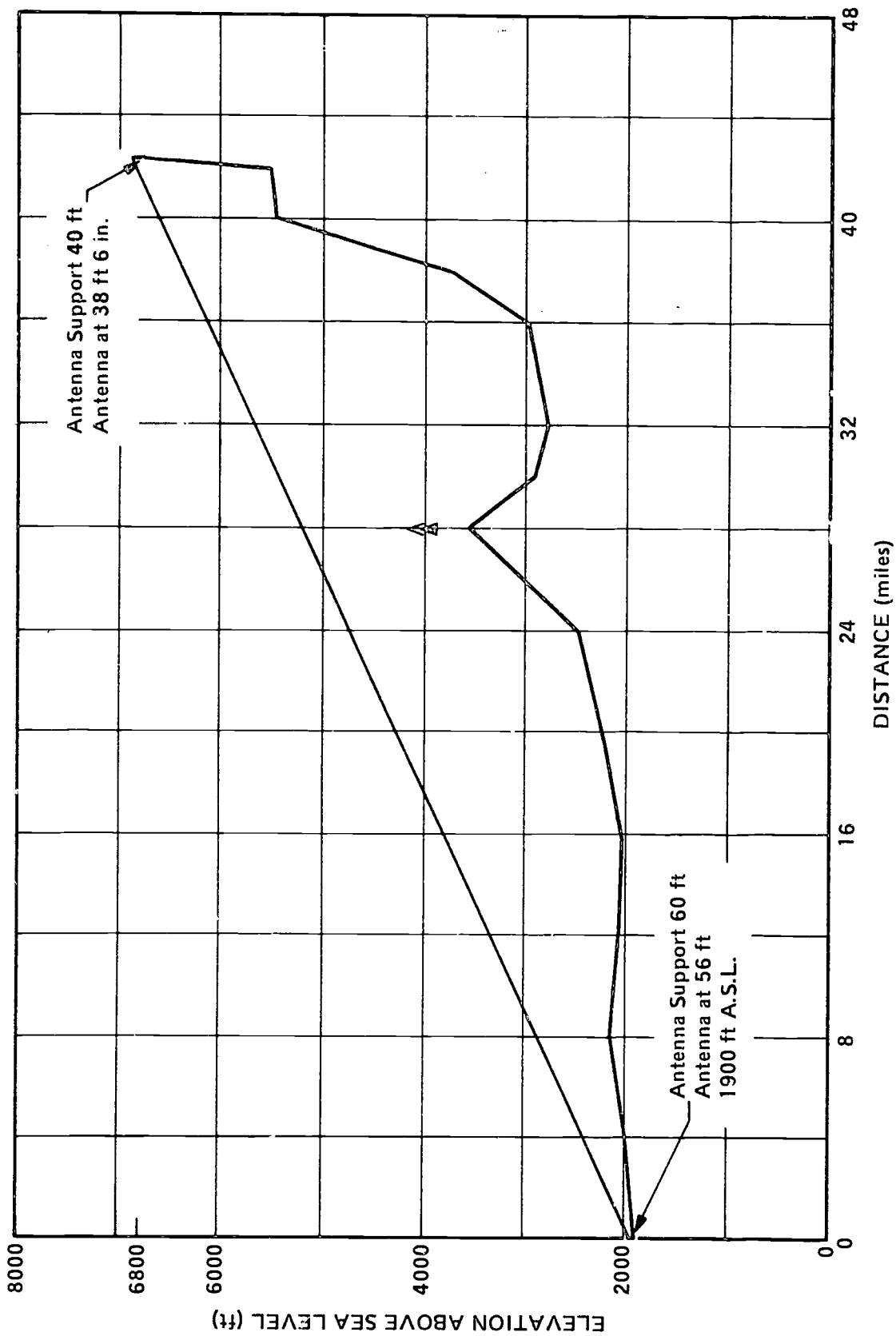

Figure A.2. Microwave Path Profile, Pisanimo to Kitt Peak.

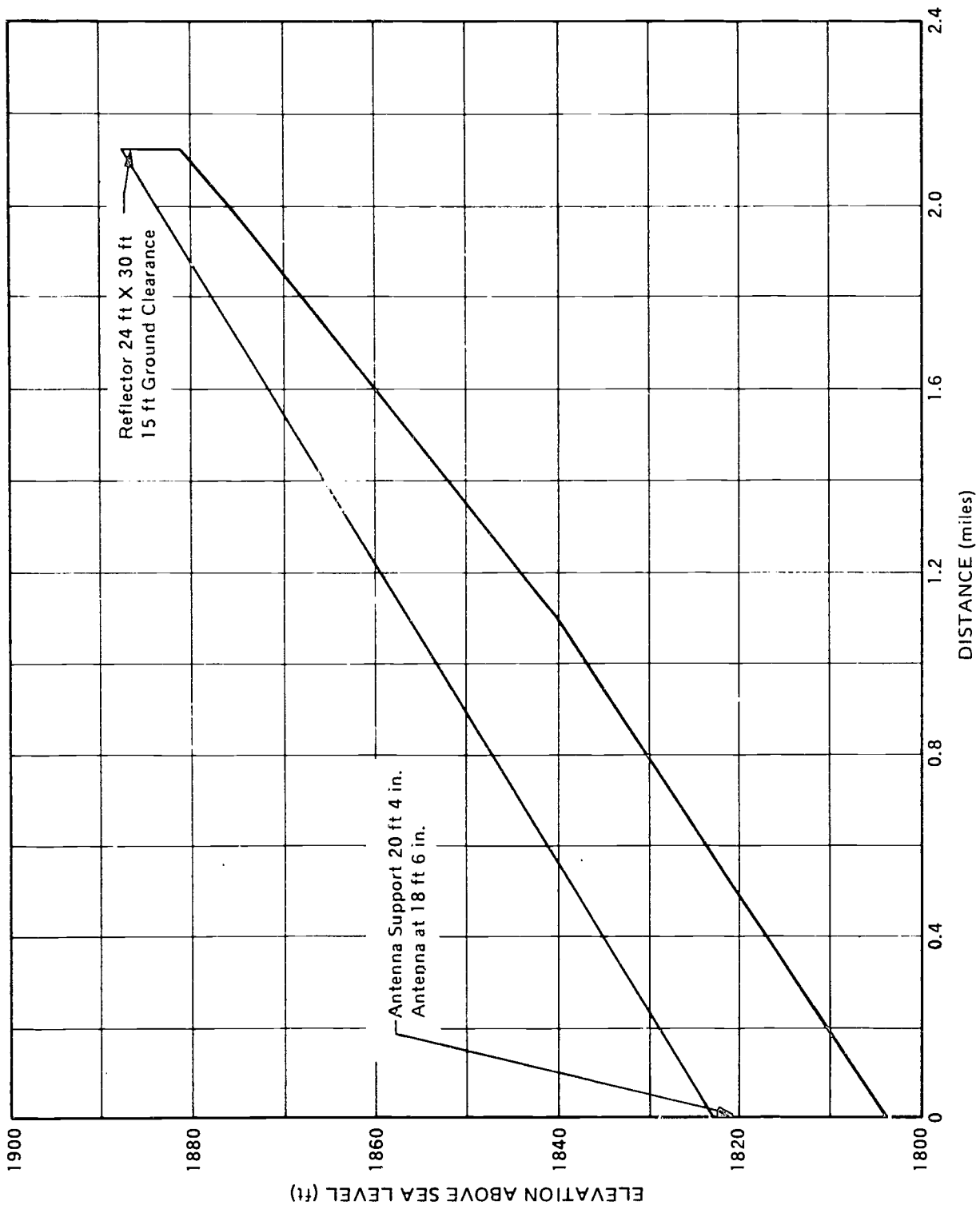

Figure A.3. Microwave Path Profile, Santa Rosa (Guachi) to Santa Rosa Reflector.

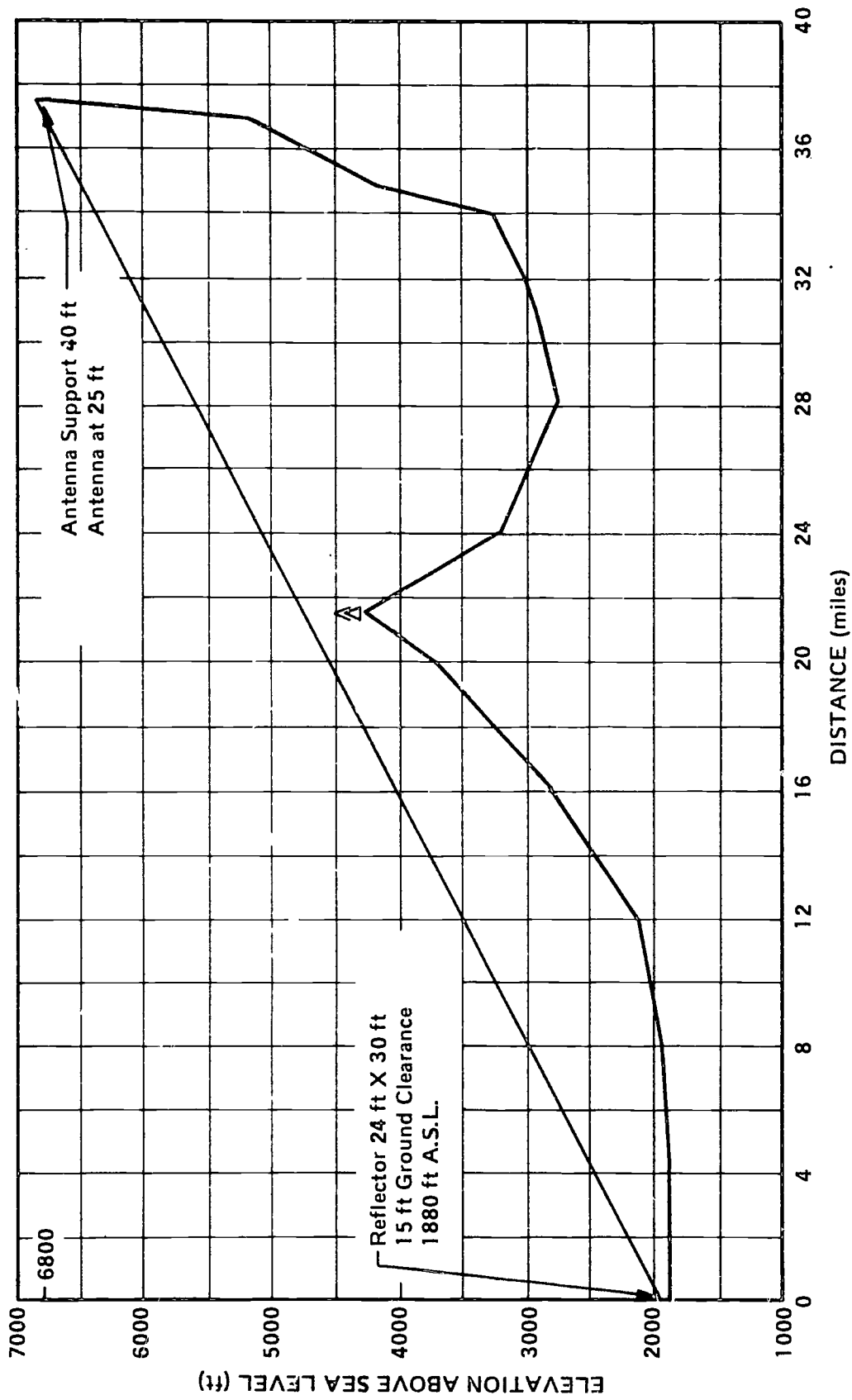

Figure A.4. Microwave Path Profile, Santa Rosa Reflector to Kitt Peak.

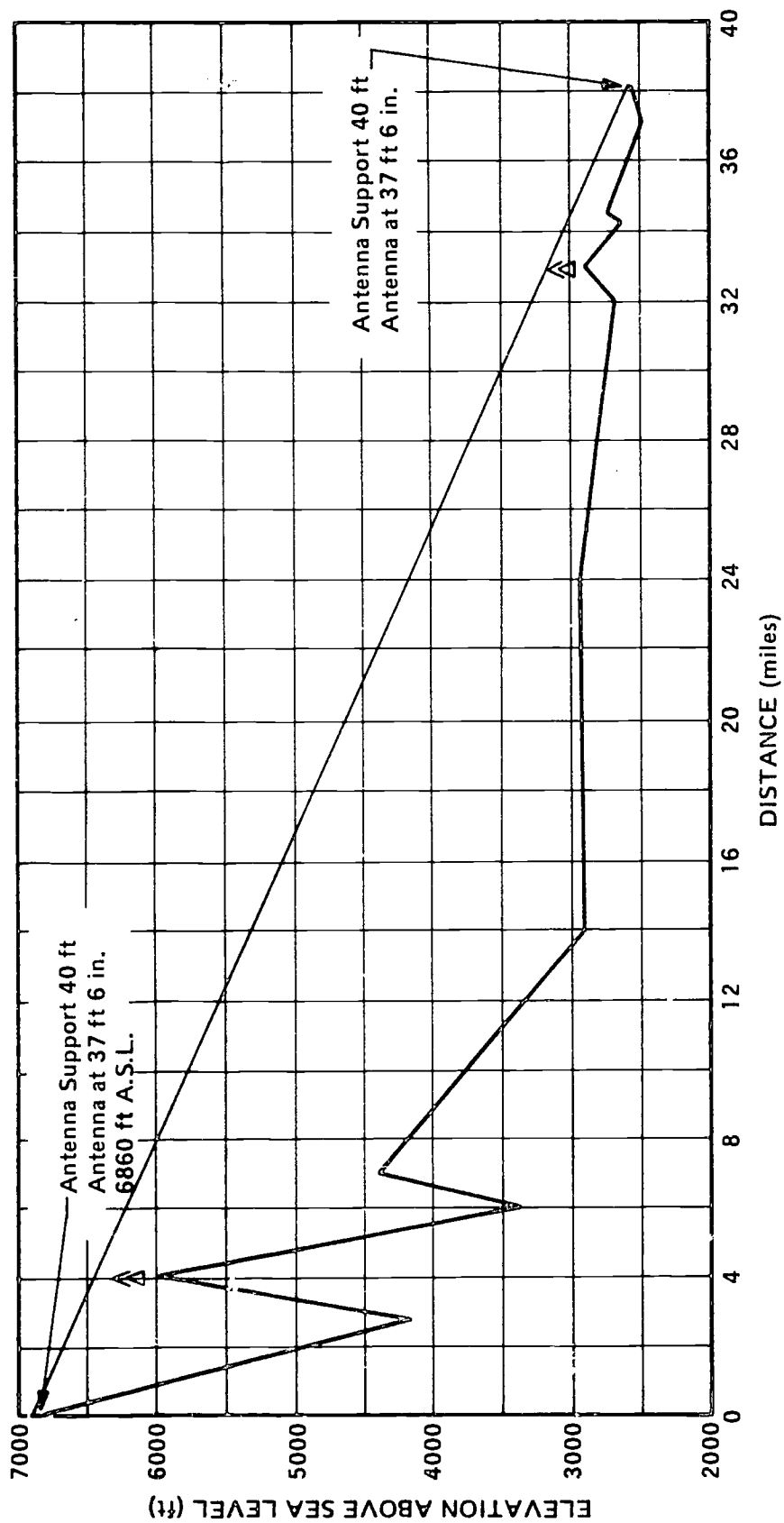

Figure A.5. Microwave Path Profile, Kitt Peak to San Xavier Antenna.



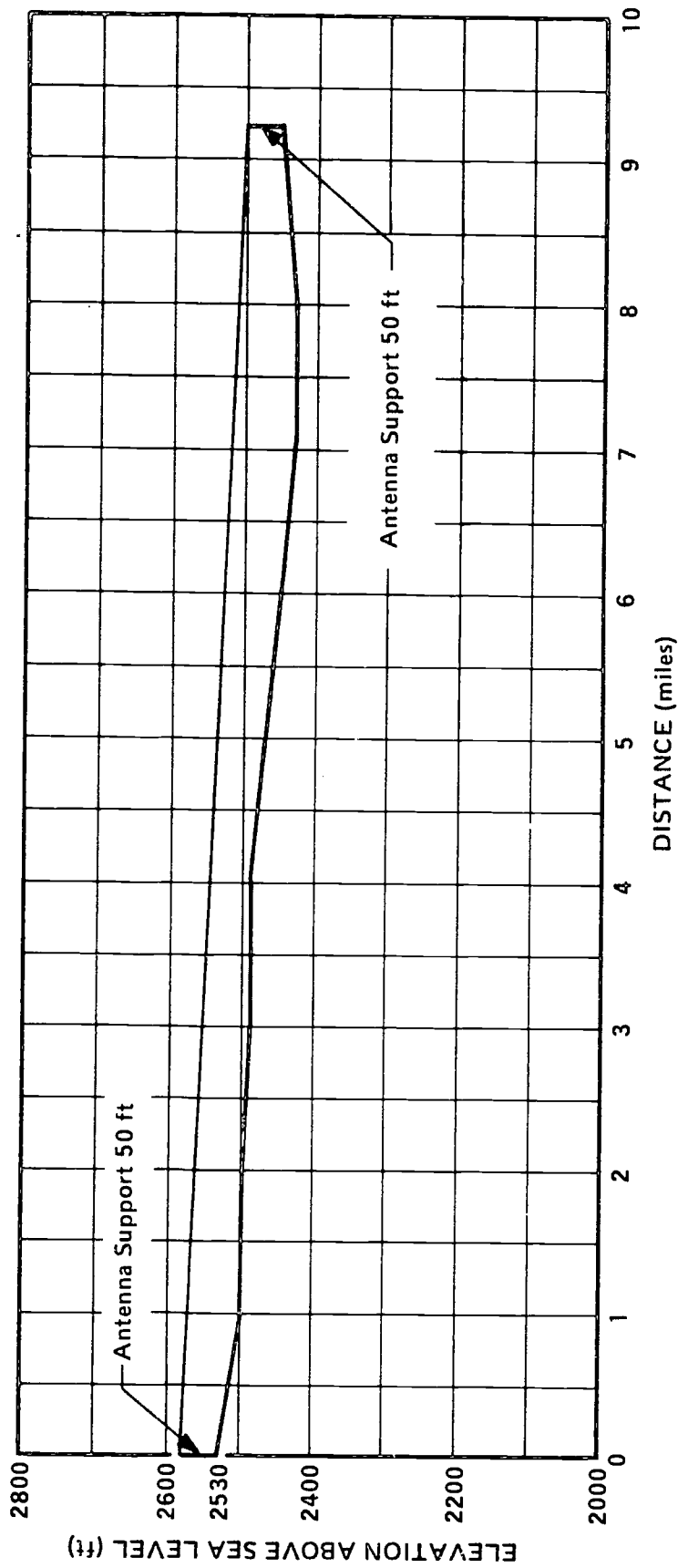

Figure A.6. Microwave Path Profile, San Xavier to Tucson.

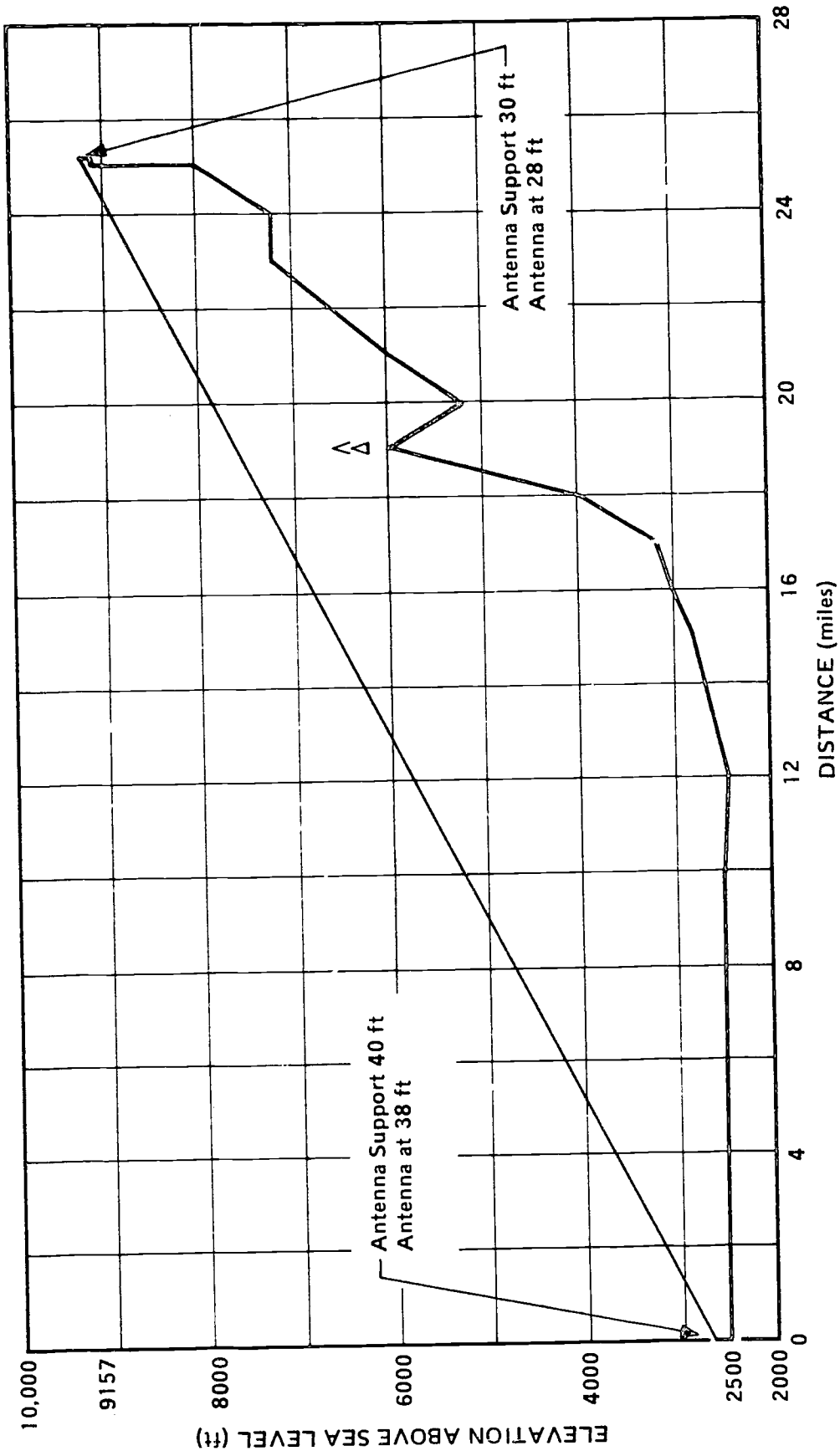

Figure A.7. Microwave Path Profile, San Xavier to Mount Lemmon.

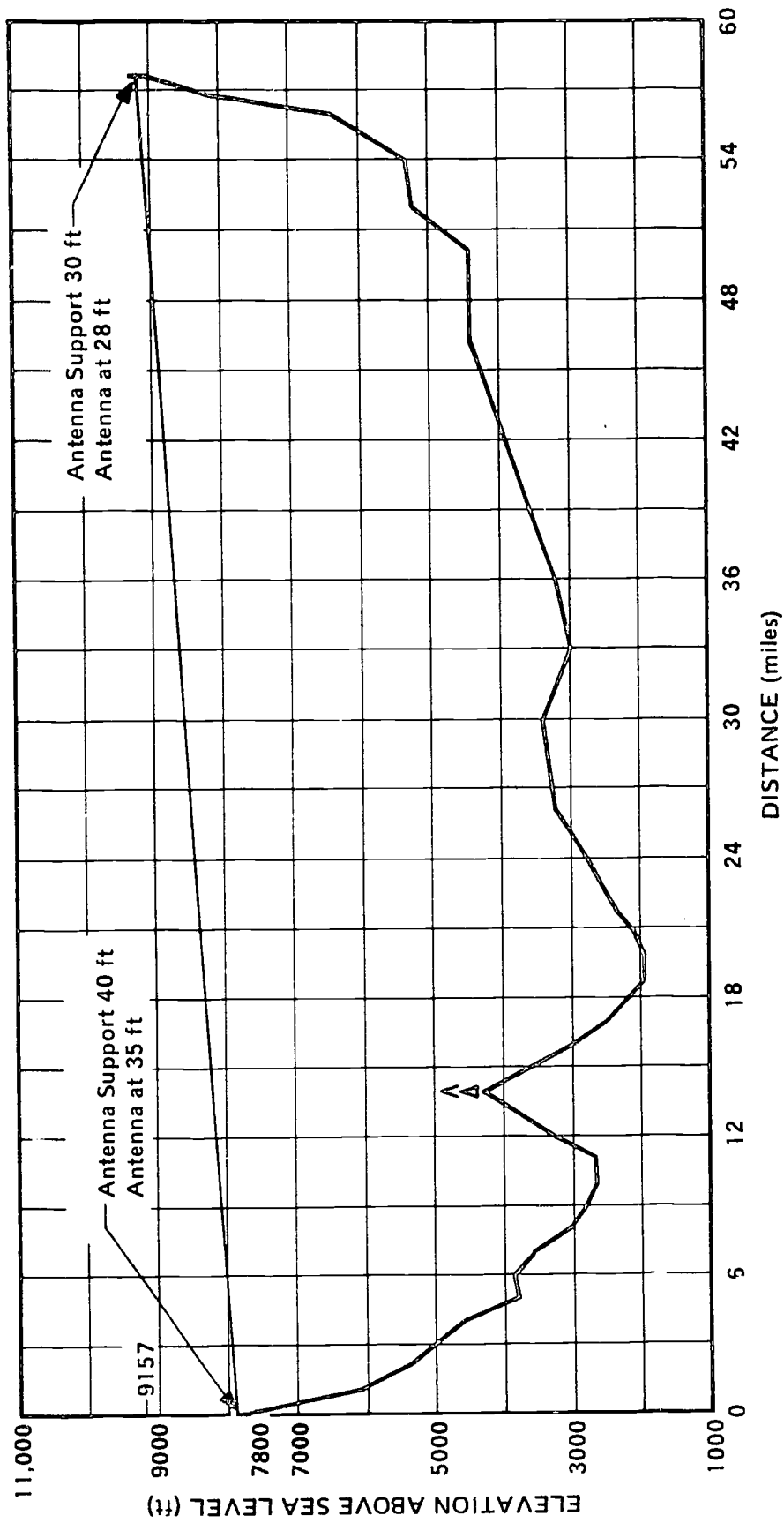

Figure A.8. Microwave Path Profile, Pinal Peak to Mount Lemmon.

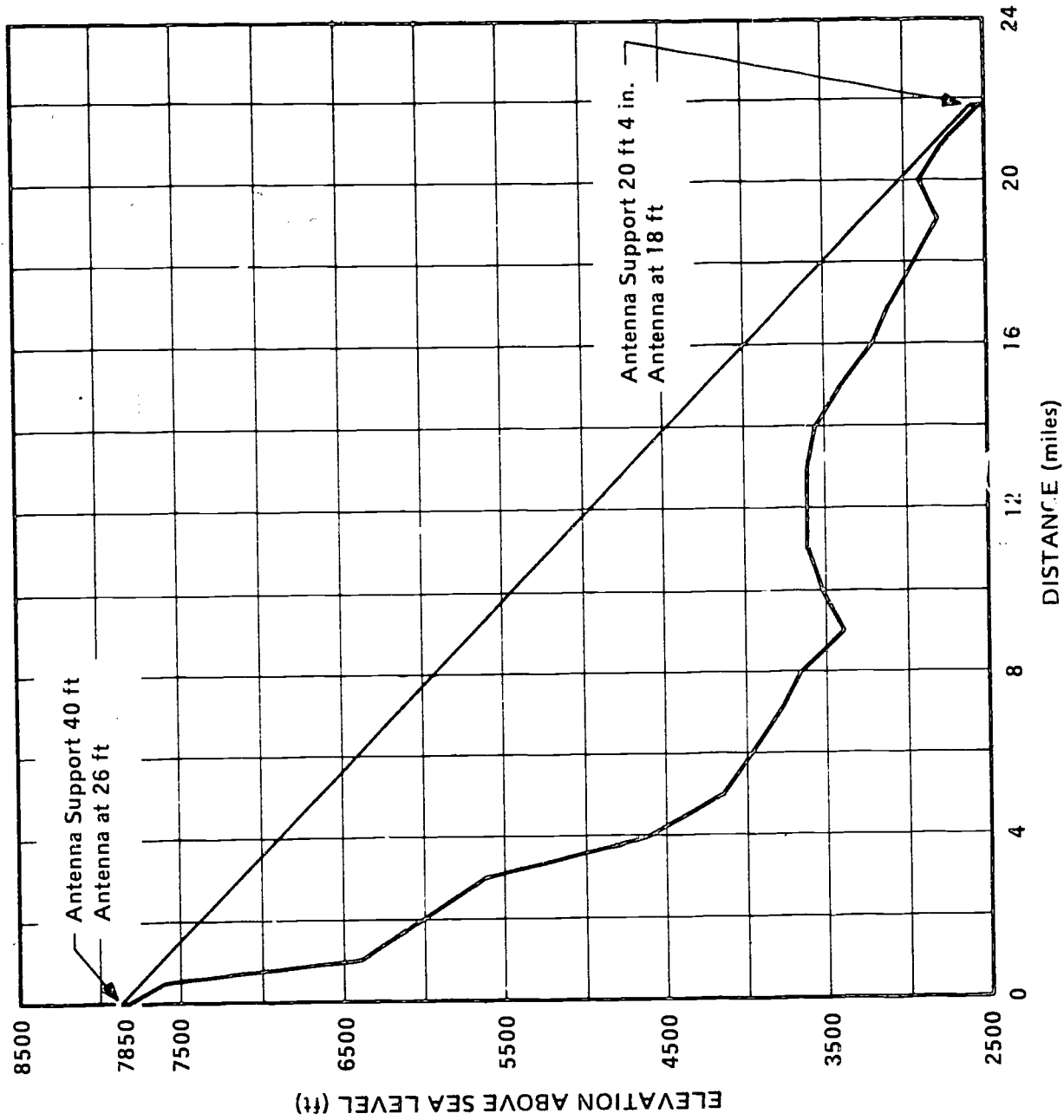

Figure A.9. Microwave Path Profile, Pinal Peak to San Carlos.

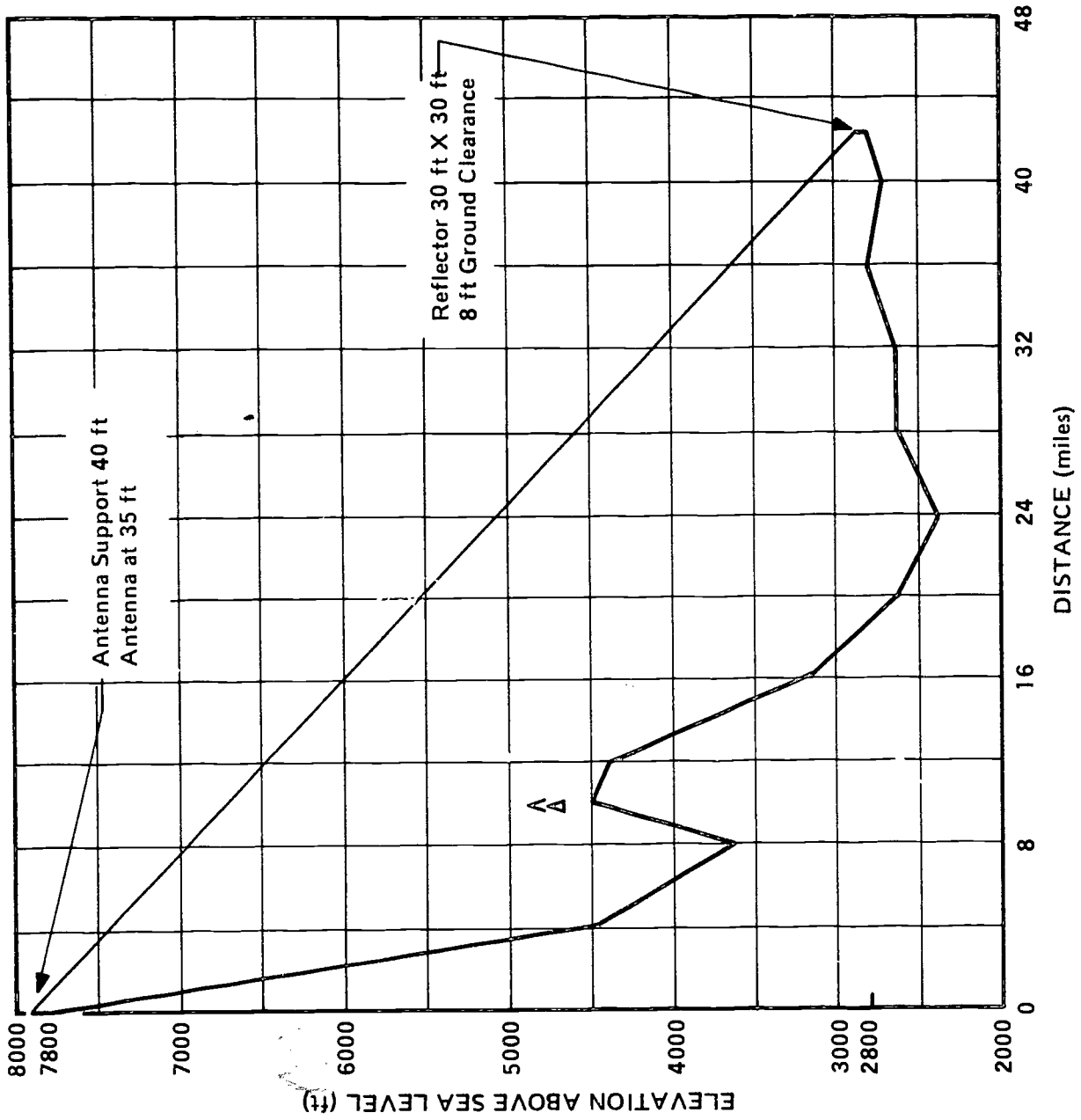

Figure A.10. Microwave Path Profile, Pinal Peak to Bylas Reflector.

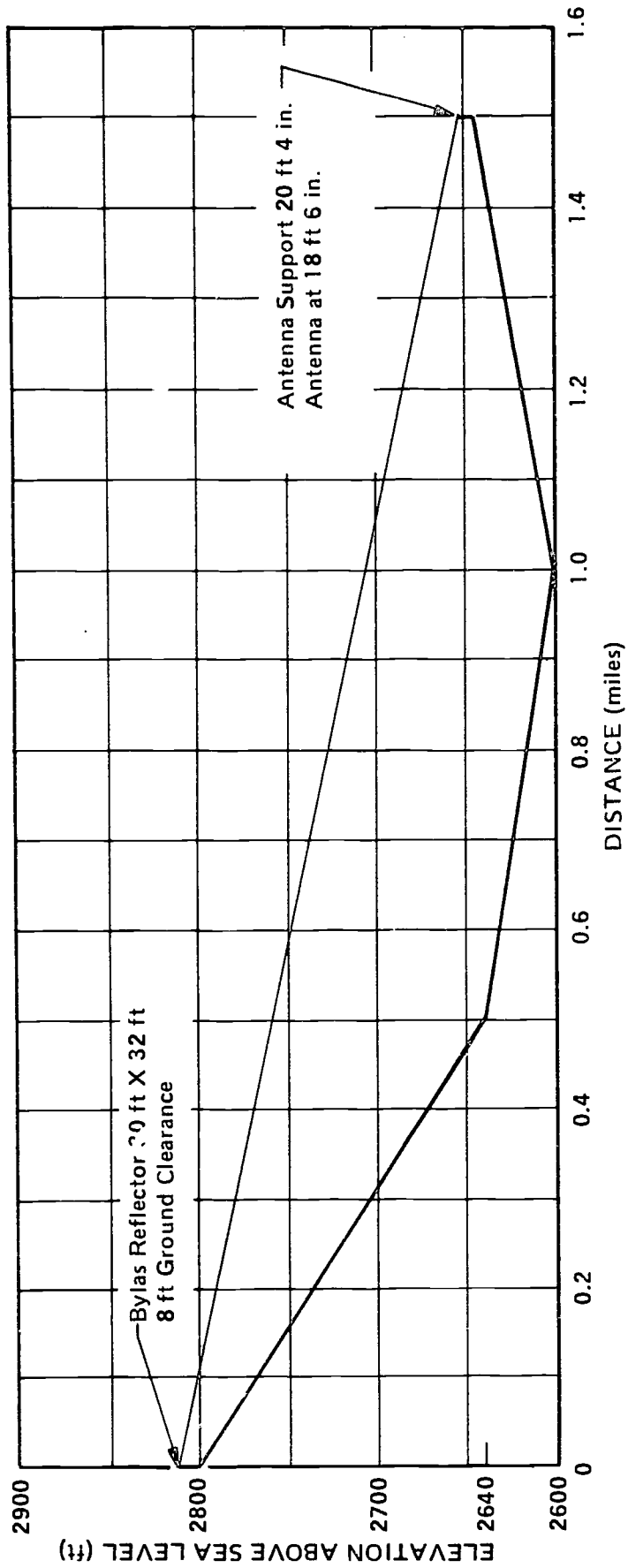

Figure A.11. Microwave Path Profile, Bylas Reflector to Bylas.

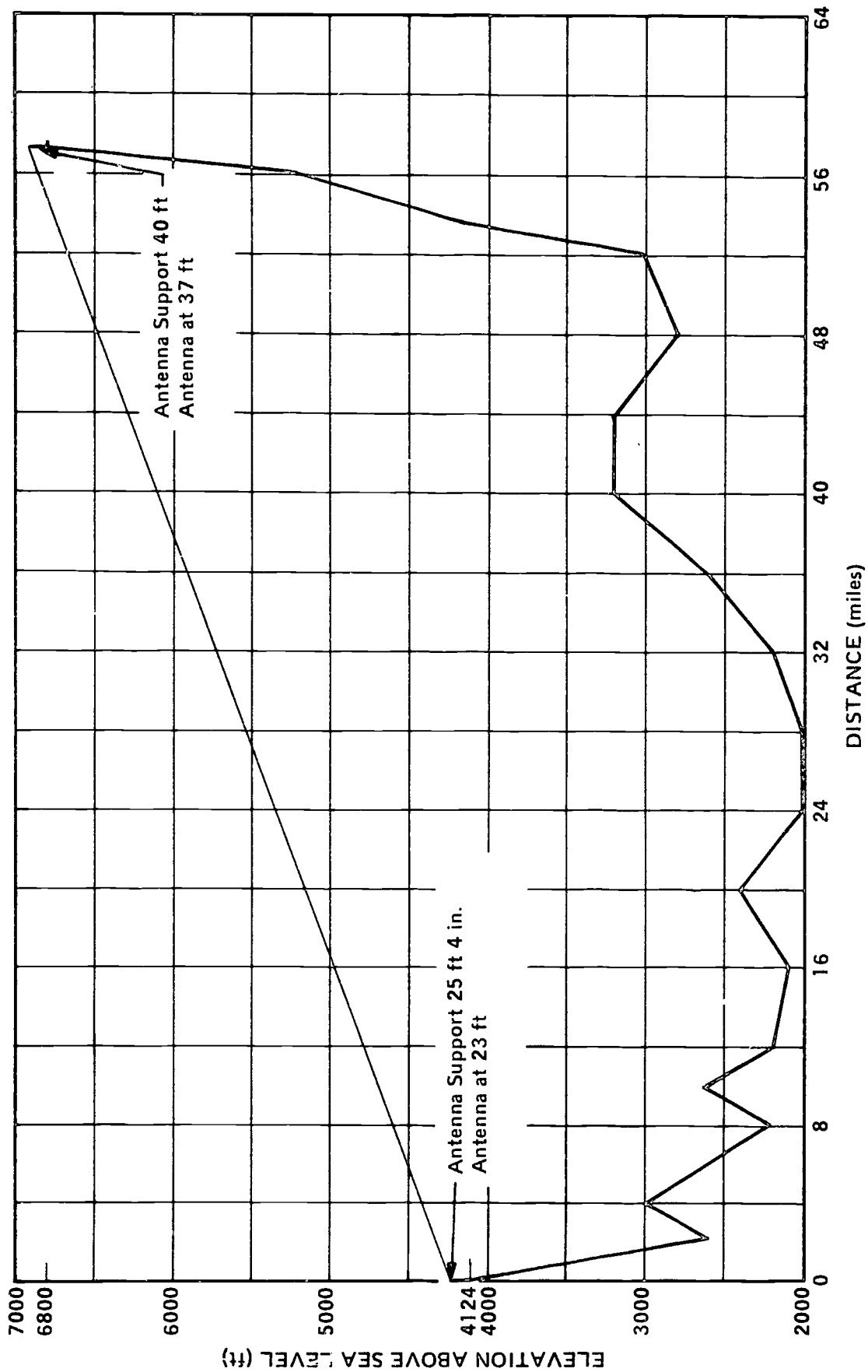

Figure A.12. Microwave Path Profile, Cimarron Peak to Kitt Peak.

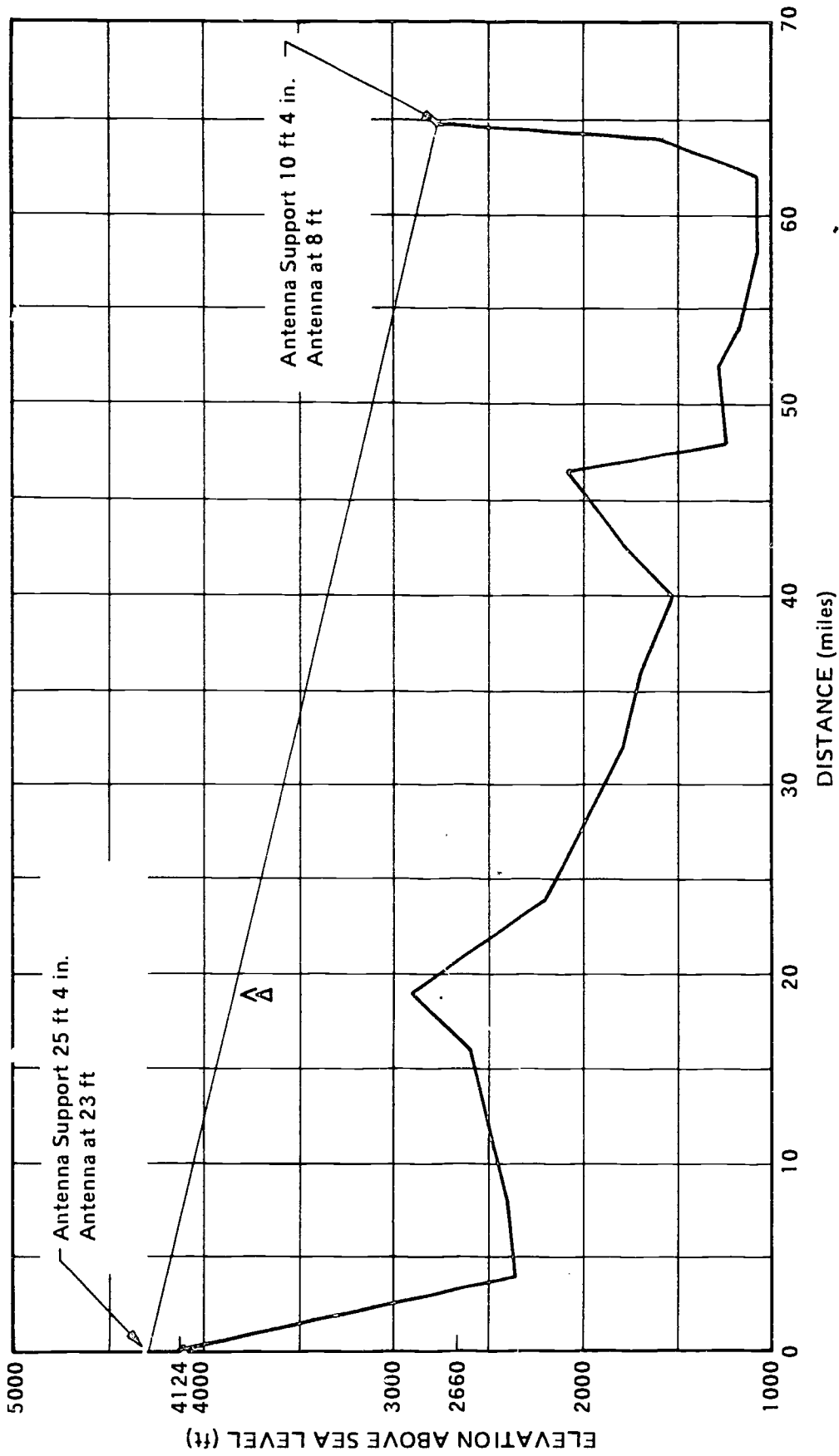

Figure A.13. Microwave Path Profile, Cimarron Peak to South Mountain.



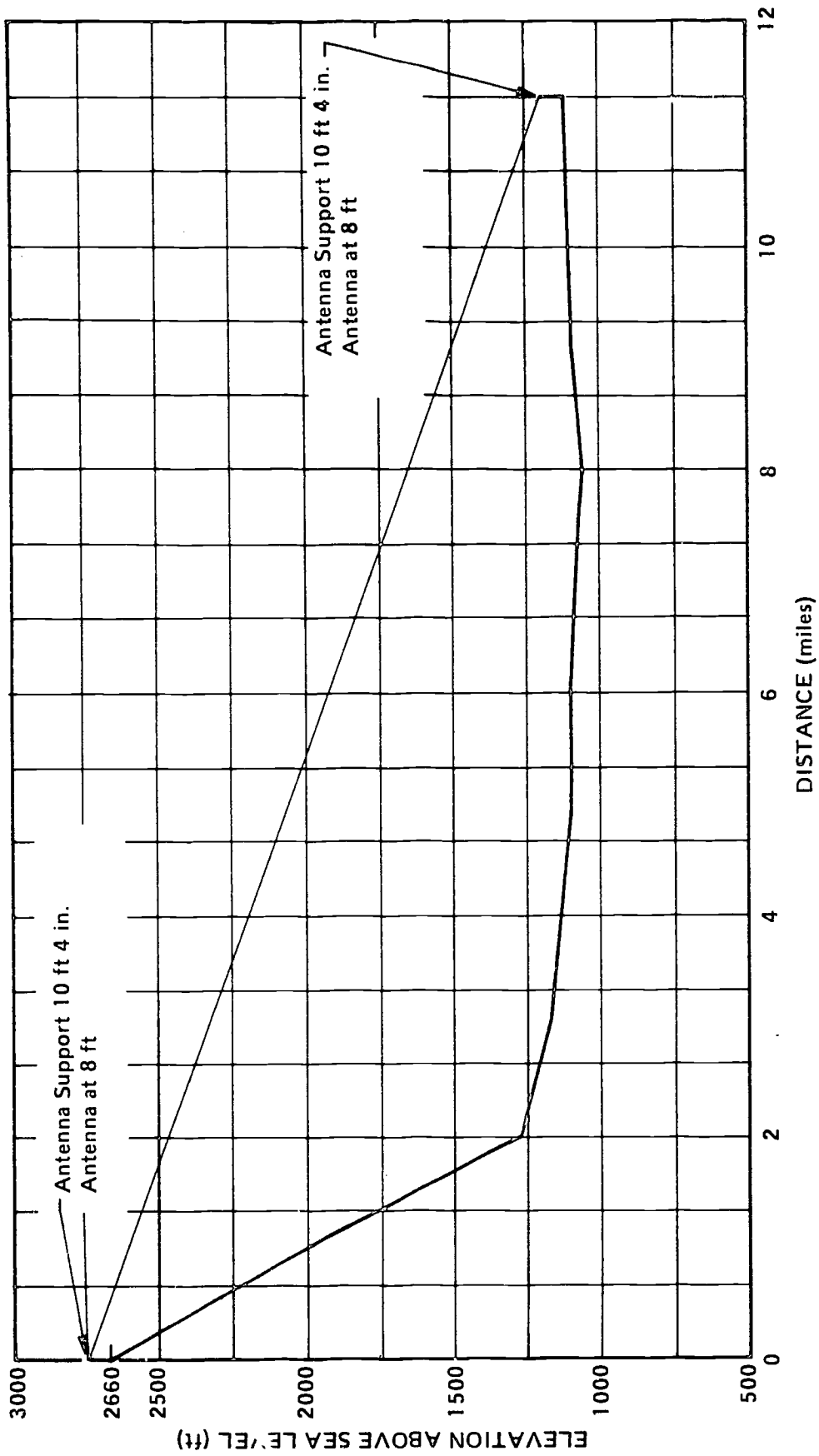

Figure A.14. Microwave Path Profile, South Mountain to Phoenix.

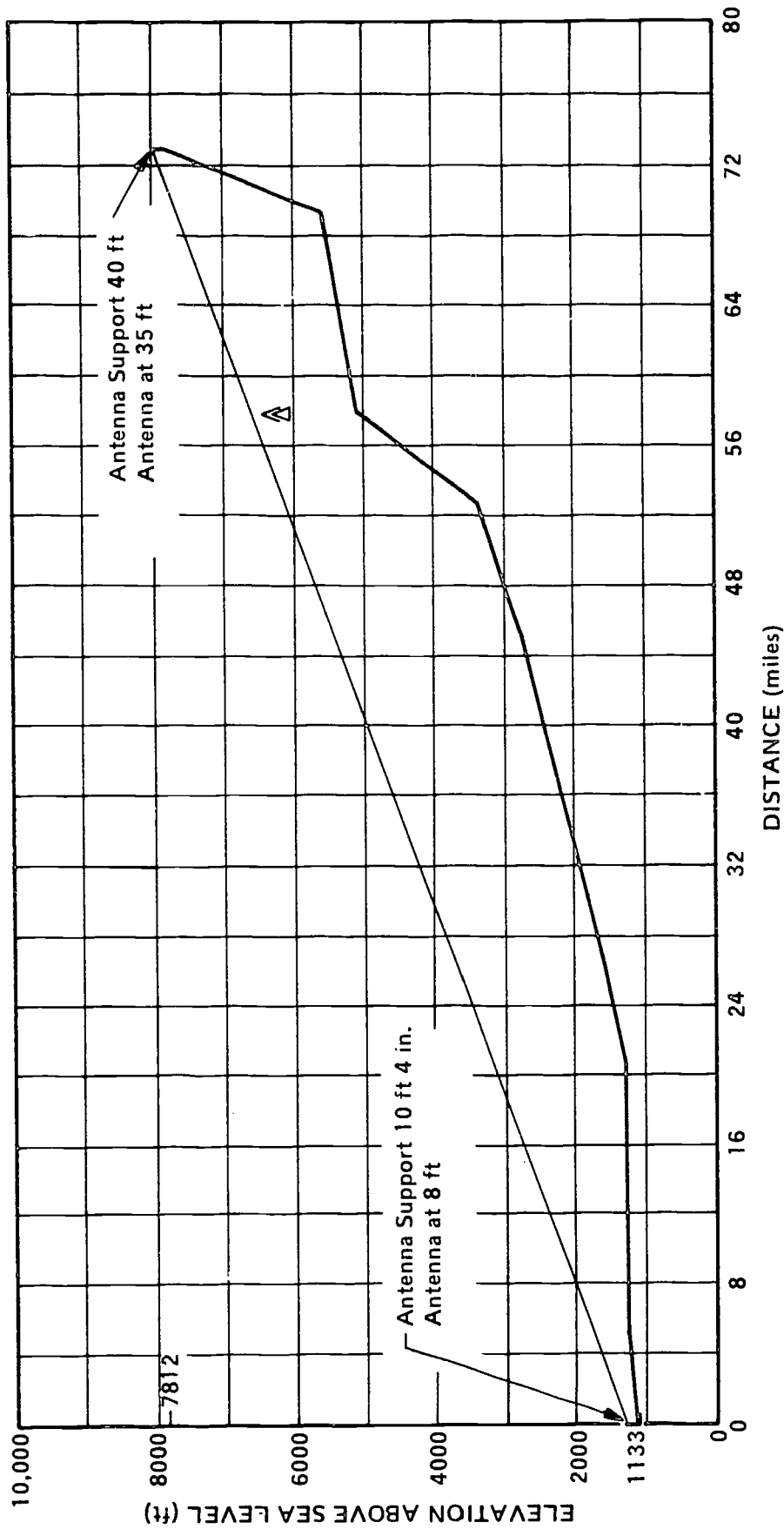

Figure A.15. Microwave Path Profile, Phoenix to Pinal Peak.

**APPENDIX B**

**SITE MAPS**

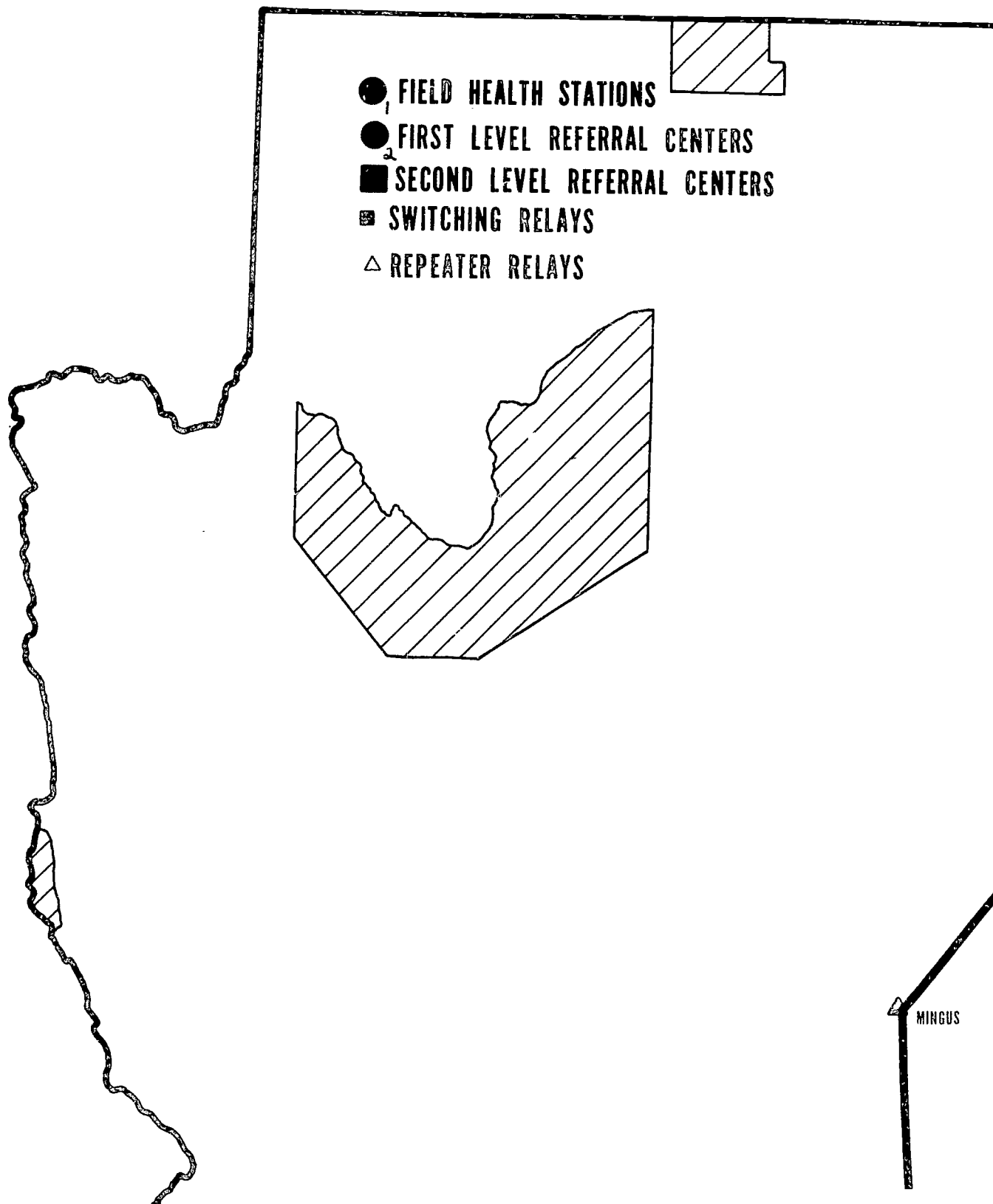

Figure B.1 Proposed Network Routing, Page #1

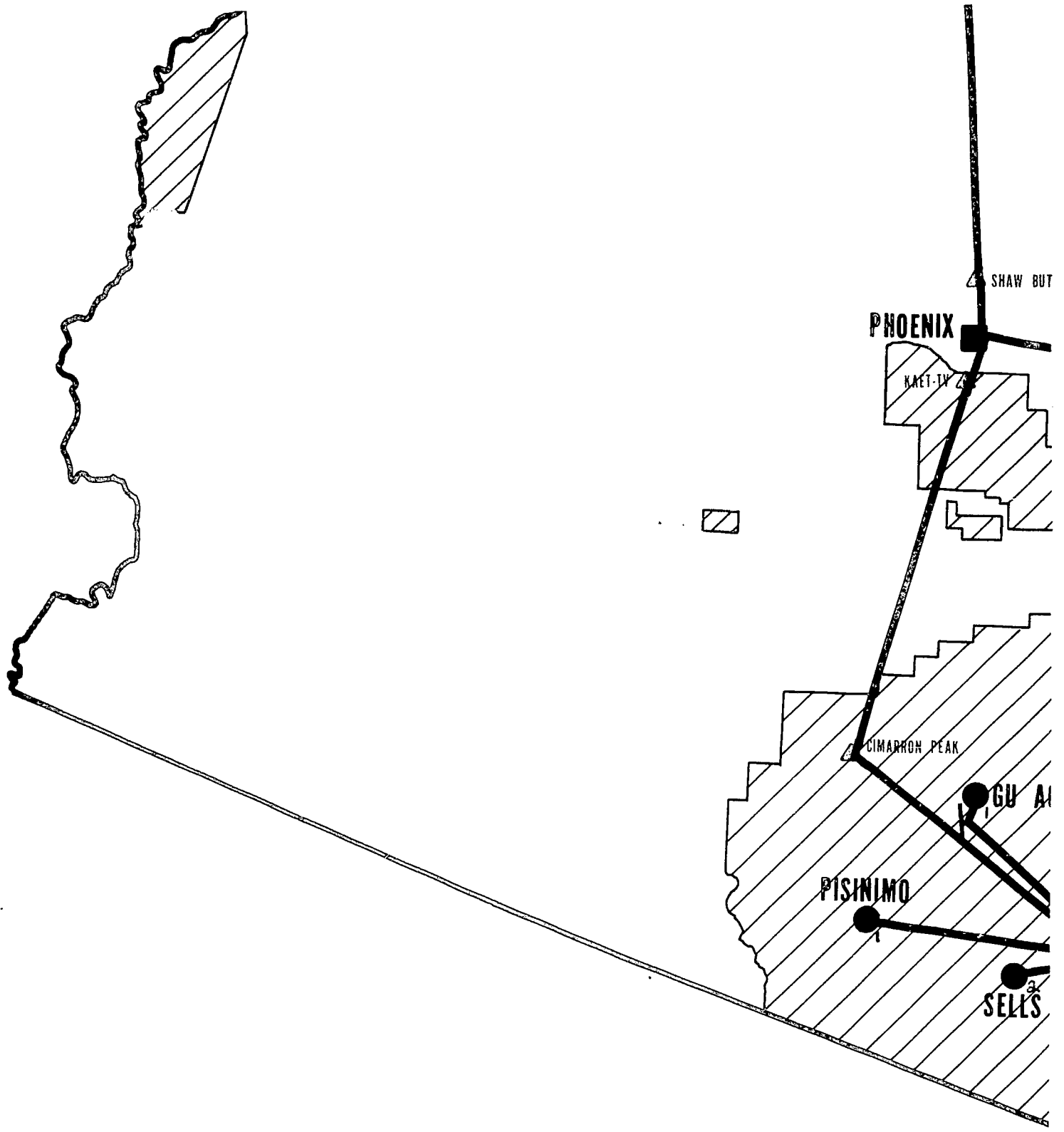
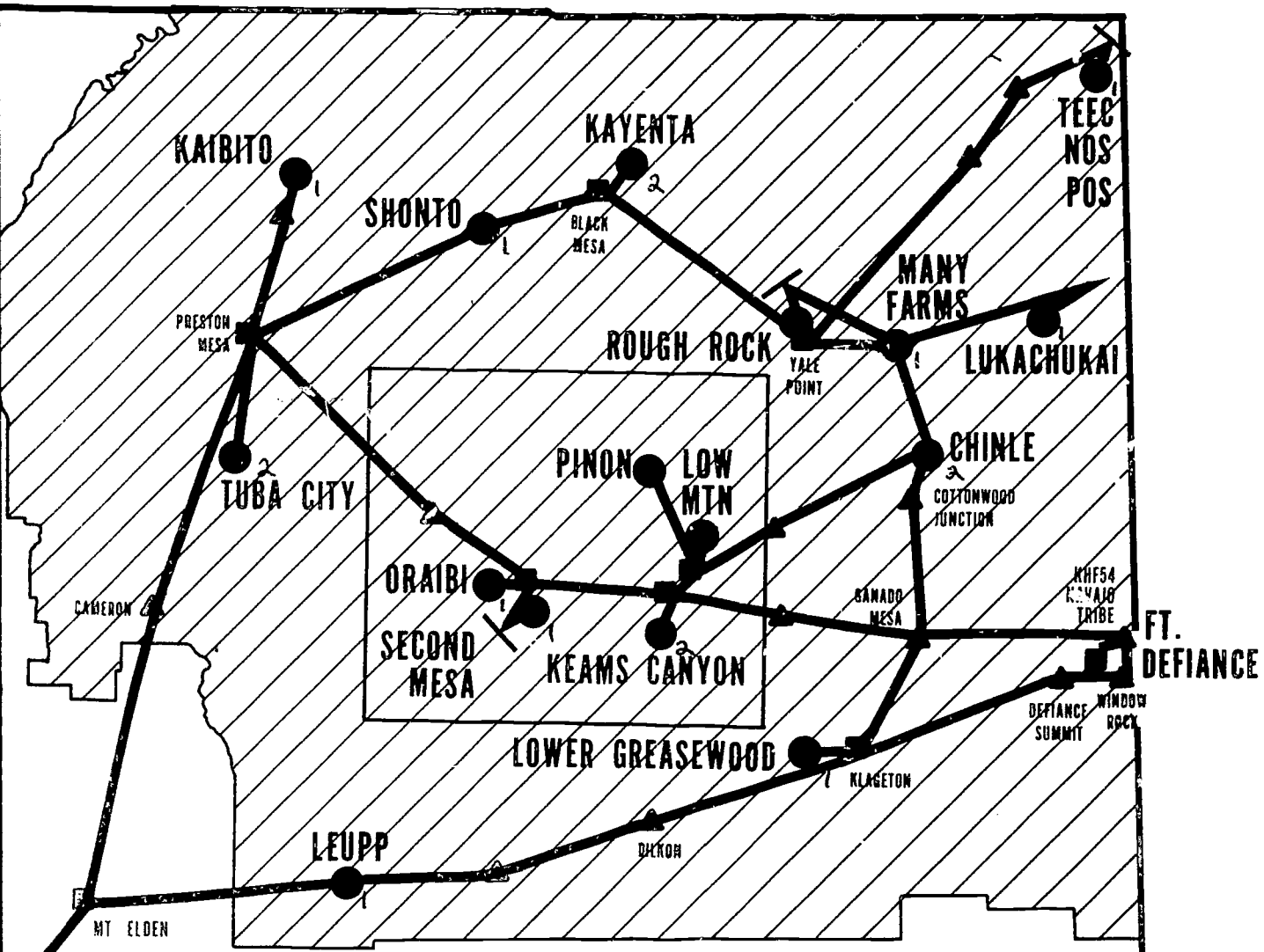

Figure B.1. Proposed Network Routing. Page #2



*M*

126  
 Figure B.1 Proposed Network Routing. Page #3

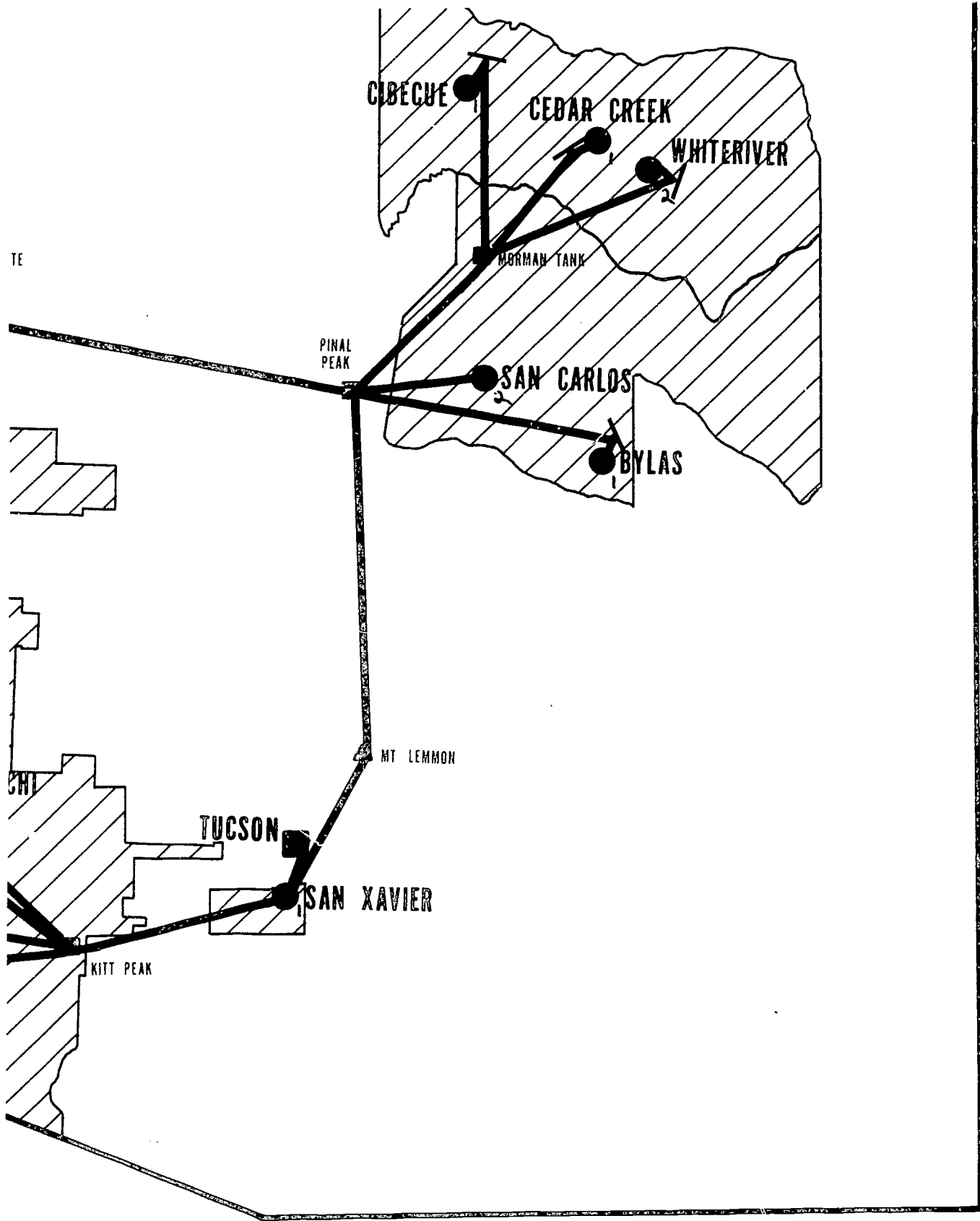

Figure B.1 Proposed Network Routing. Page #4

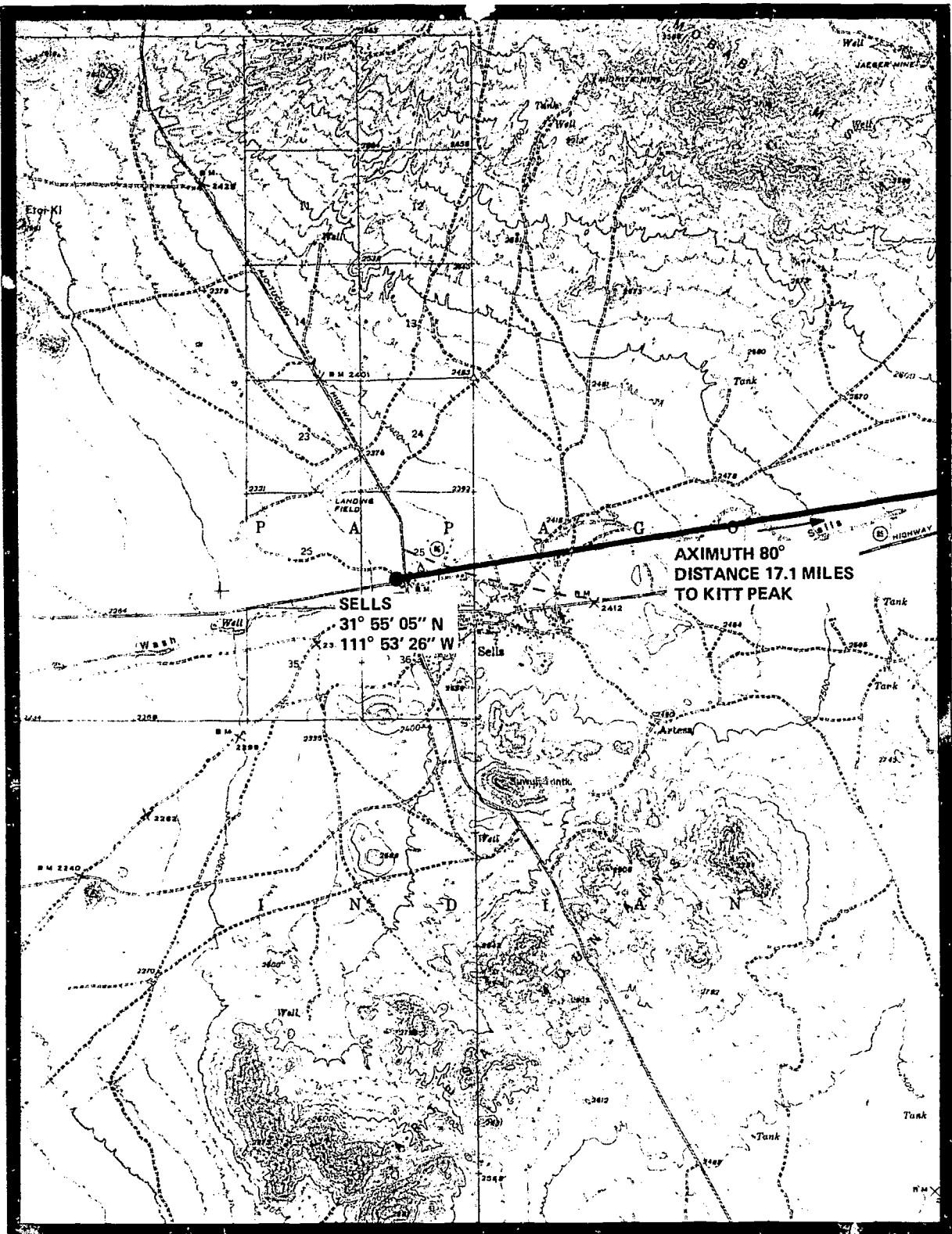

Figure B.2. Sells Site Map.



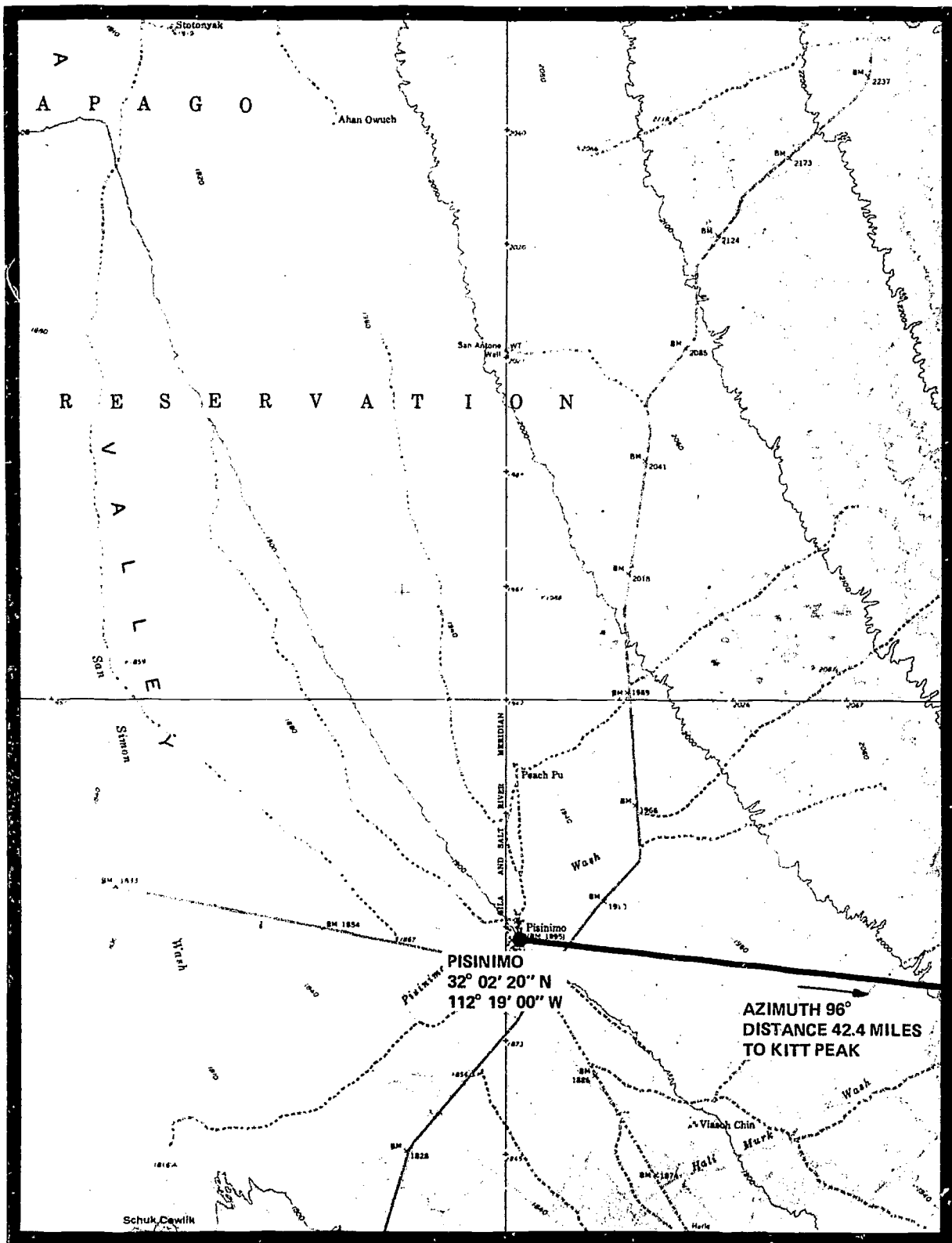

Figure B.3. Pisinimo Site Map.

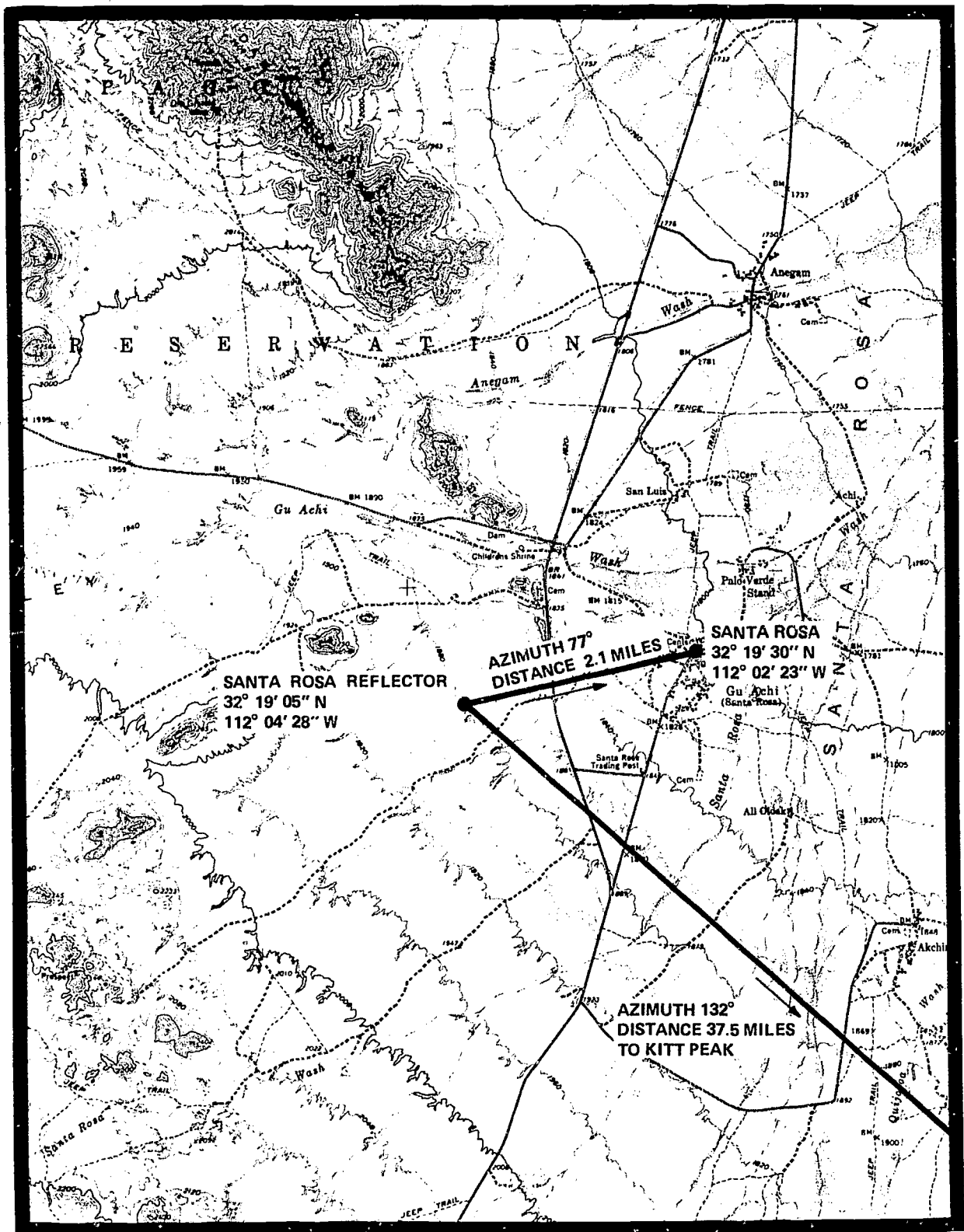

Figure B.4. Santa Rosa Site Map.



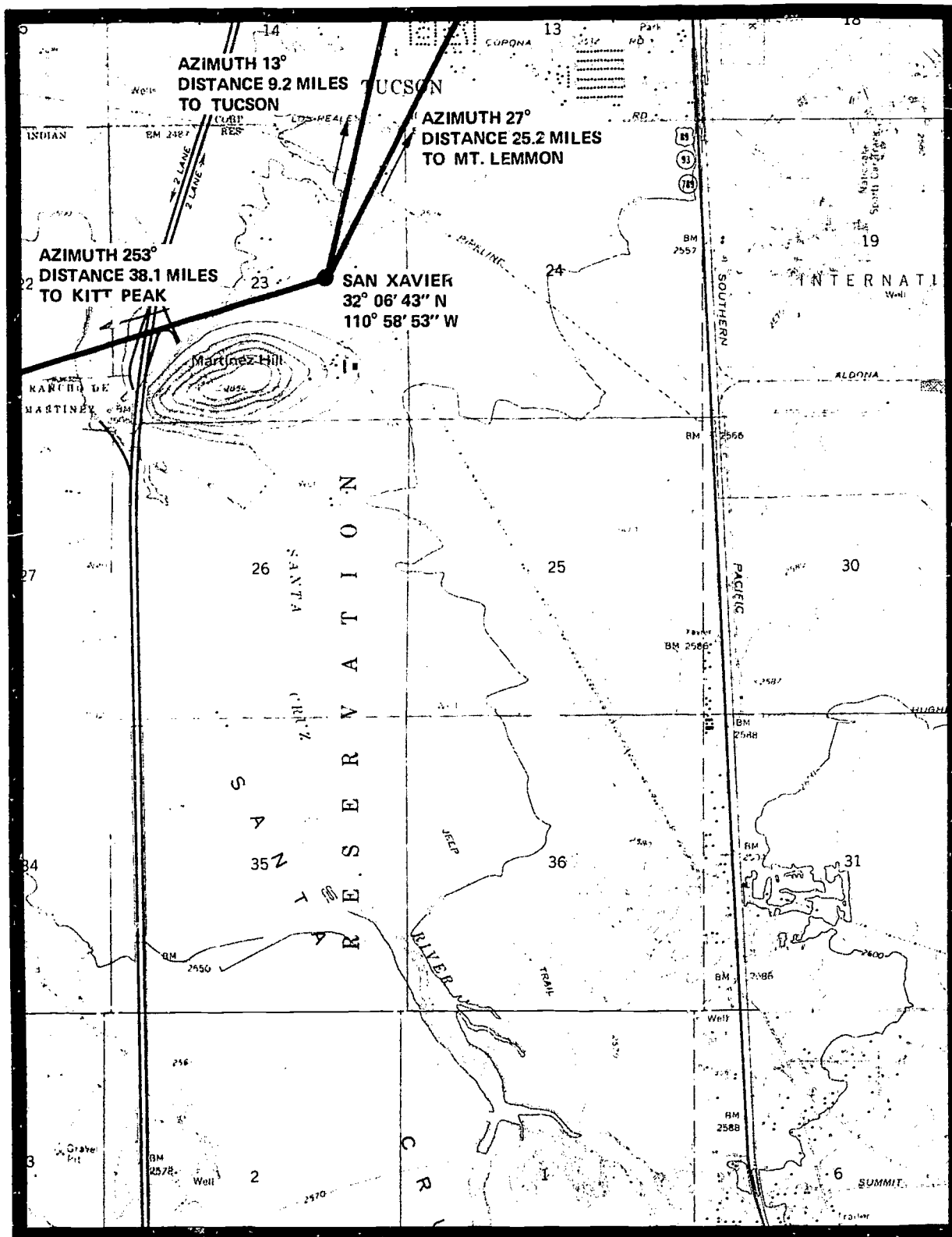

Figure B.6. San Xavier Site Map.

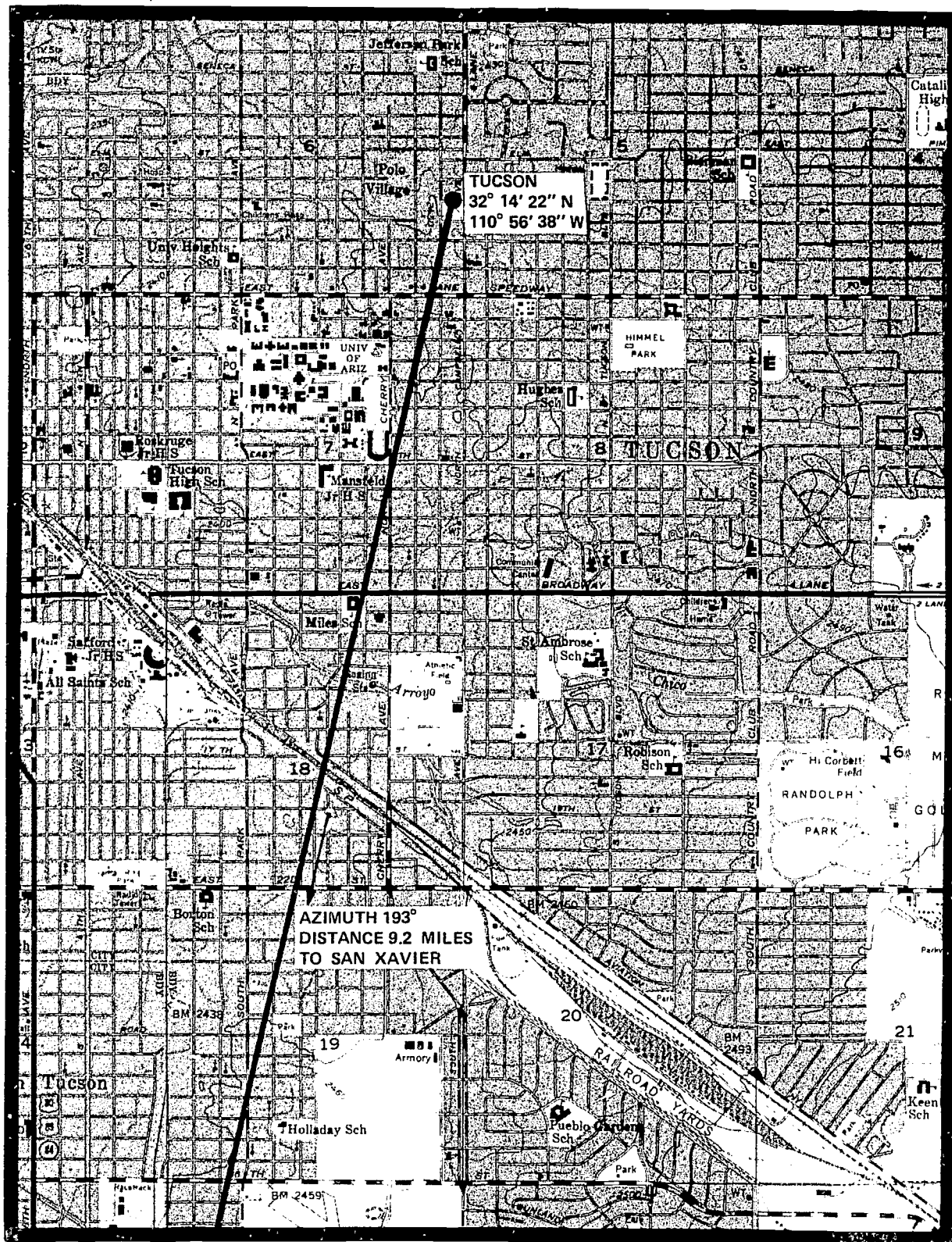

Figure B.7. Tucson Site Map.

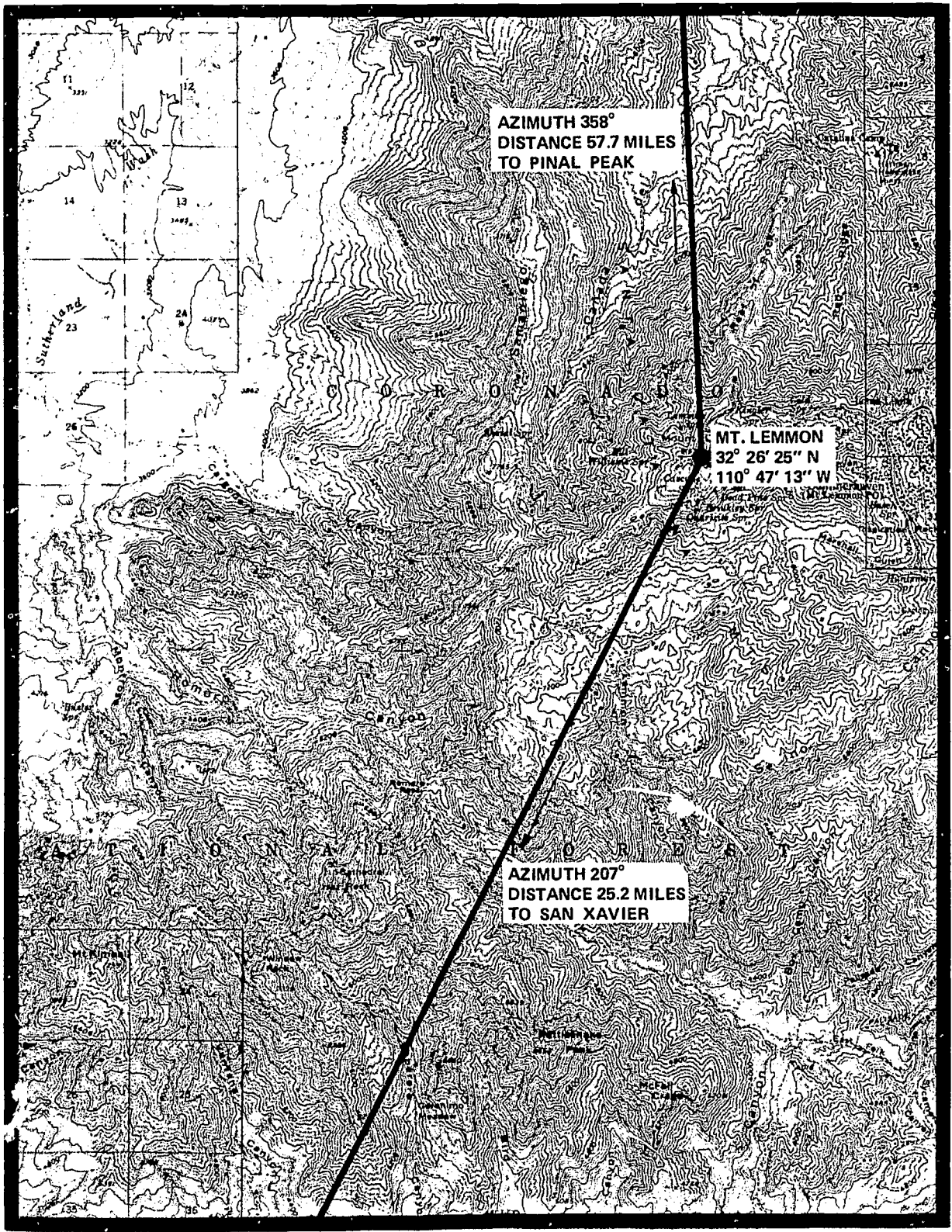

Figure B.8. Mt. Lemmon Site Map.

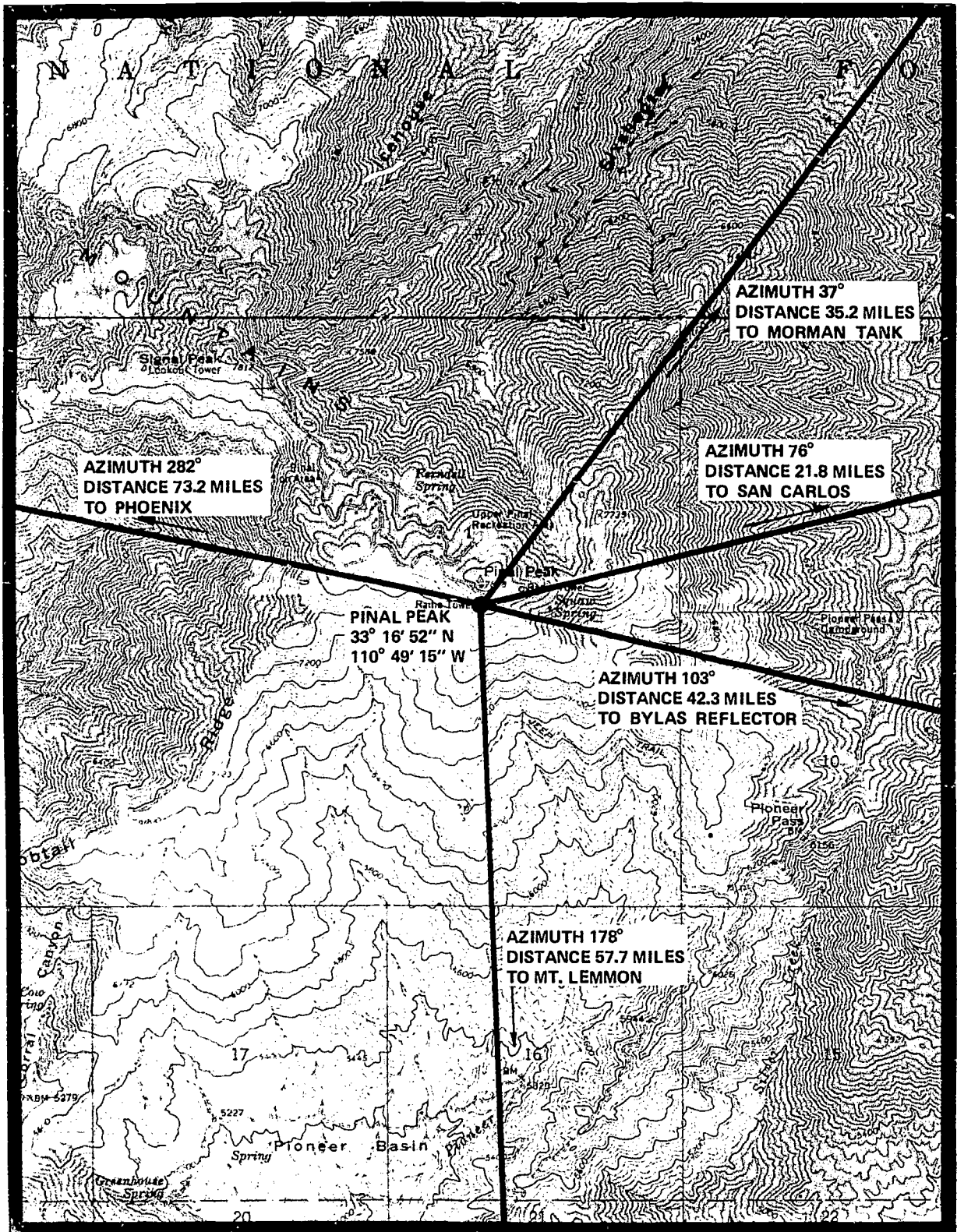

Figure B.9. Pinal Peak Site Map.





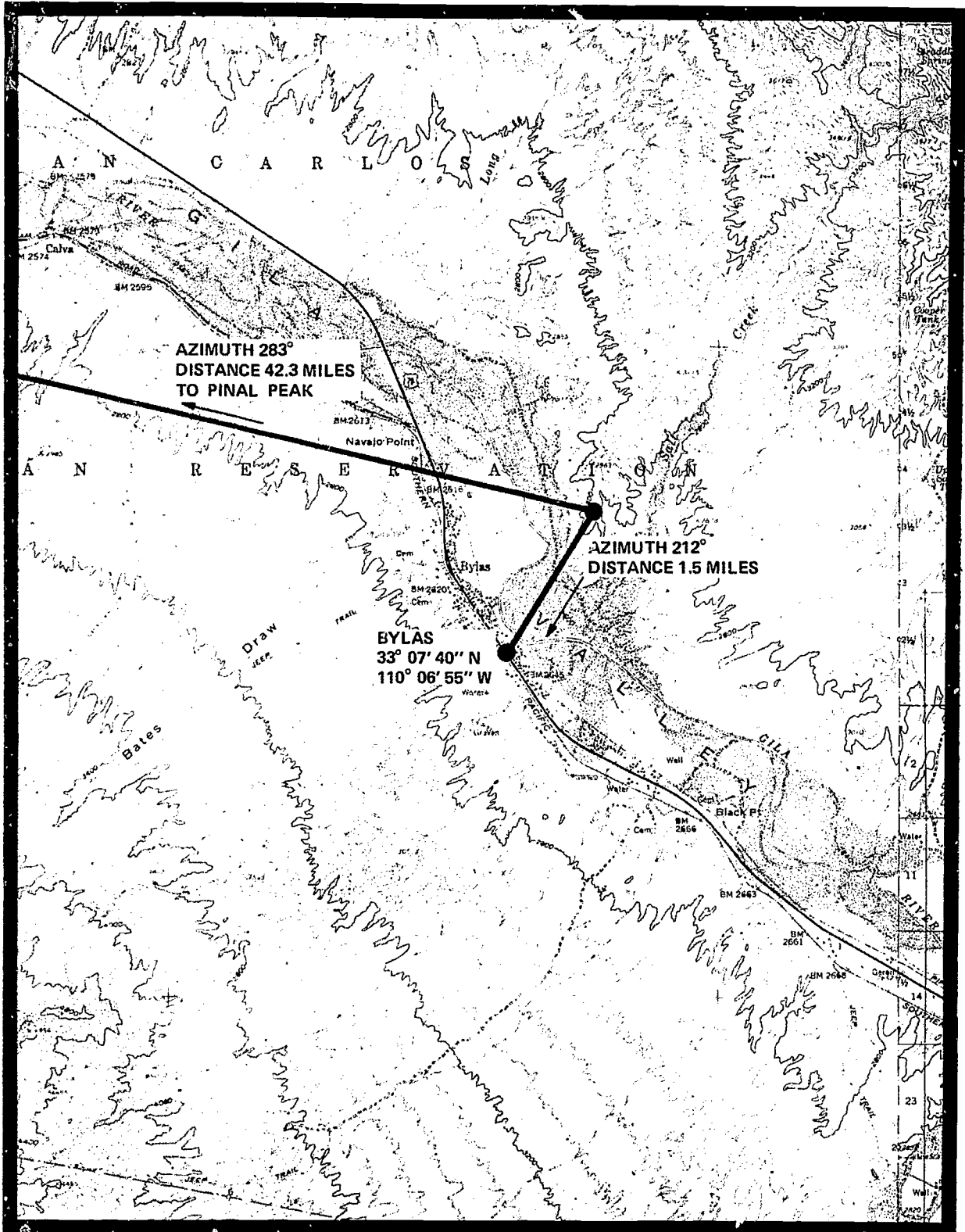

Figure B.11. Bylas Site Map.

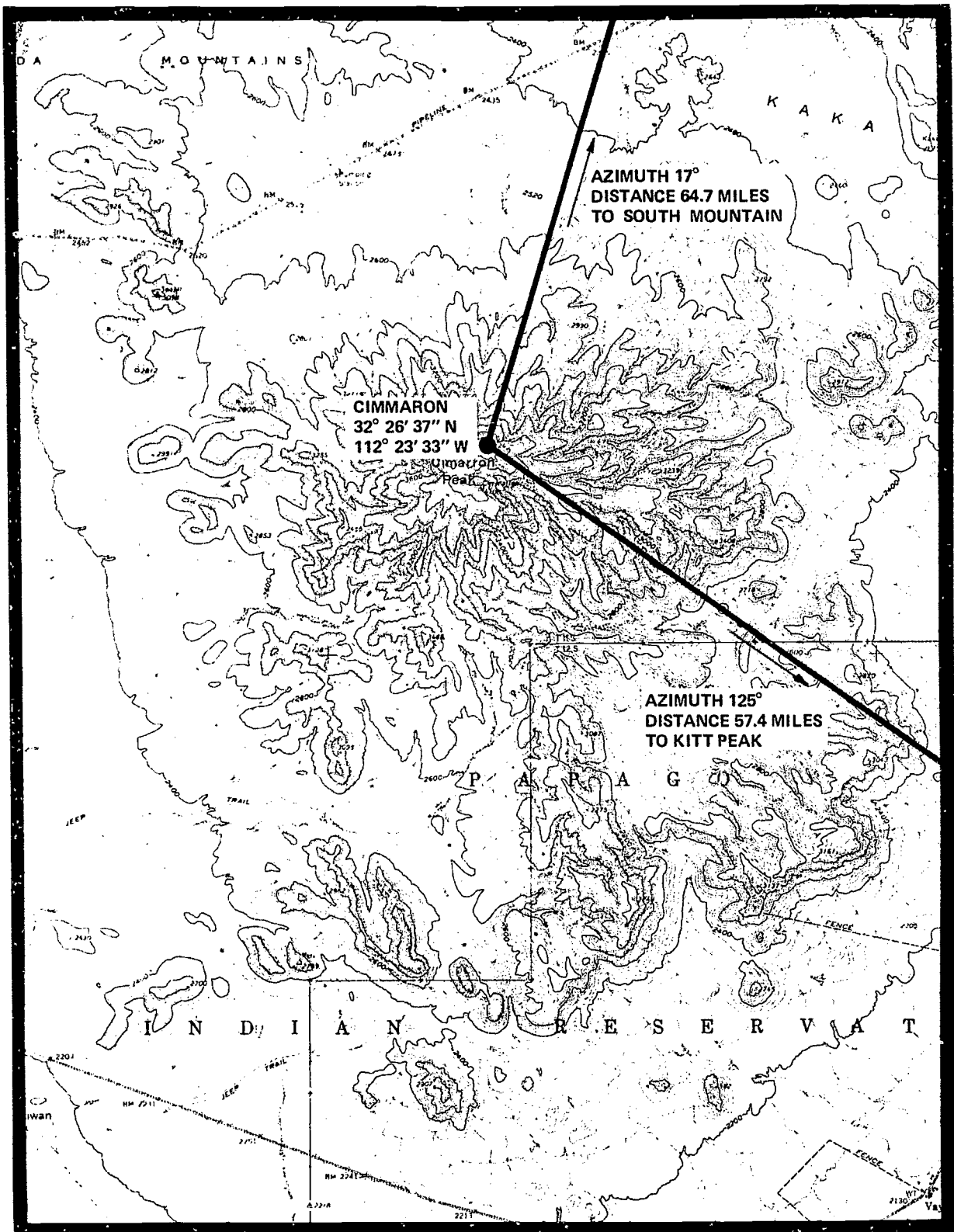

Figure B.12. Cimarron Peak Site Map.





APPENDIX C

SITE PHOTOGRAPHS

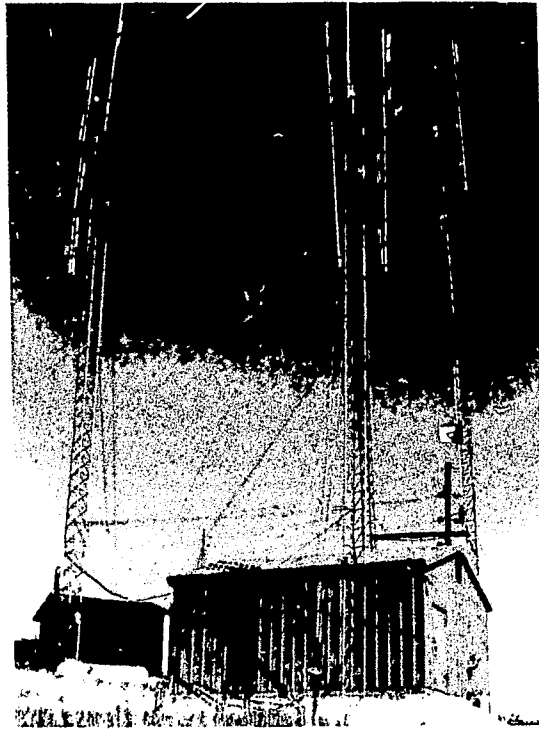

Figure C-1. Mt. Lemmon, Showing the Existing Facilities of General Communications, Inc.

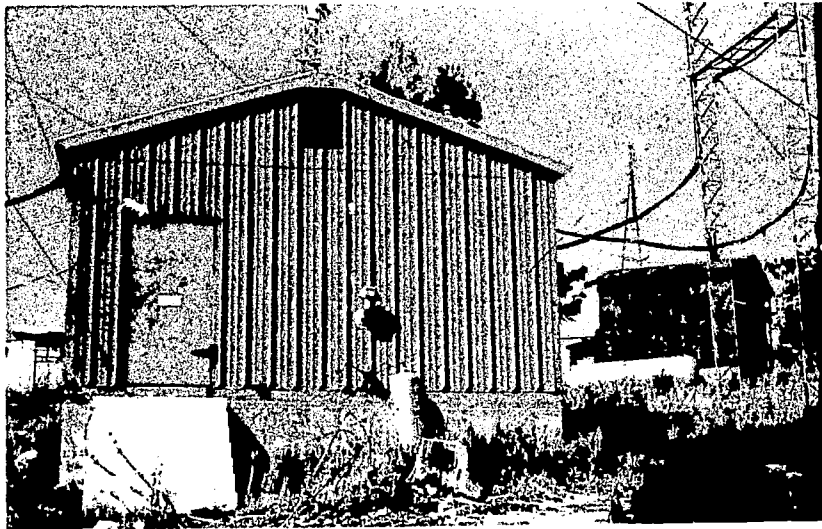

Figure C-2. Mt. Lemmon, Showing the General Communications Communications Equipment Building and Generator

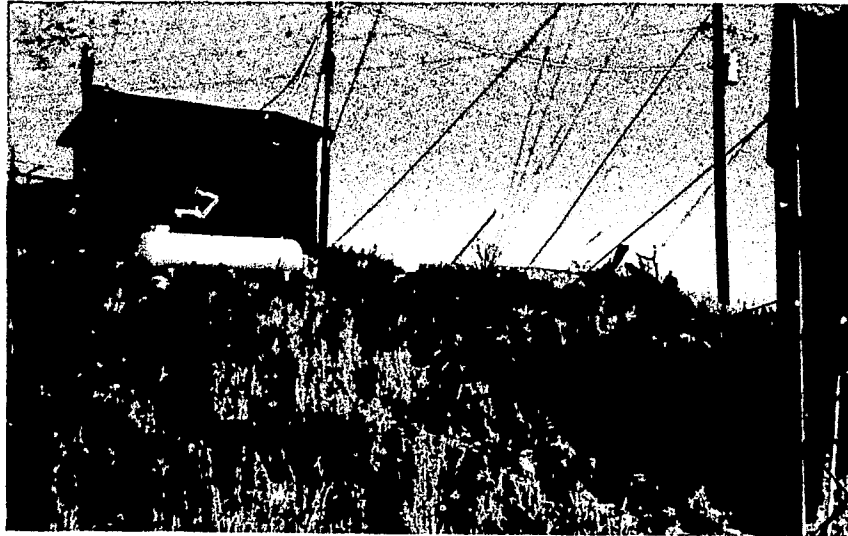

Figure C-3. Mt. Lemmon, Showing the Existing Generator Building and Location (center) of Proposed Tower.

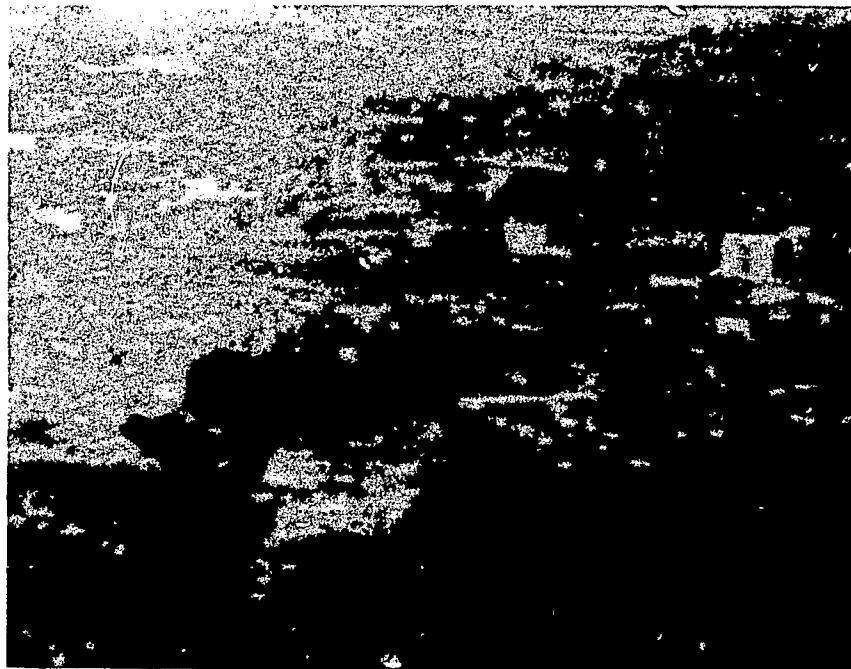

Figure C-4. Telescopic View of Tucson from Mt. Lemmon. Note that line-of-sight to the Medical Center does not exist.

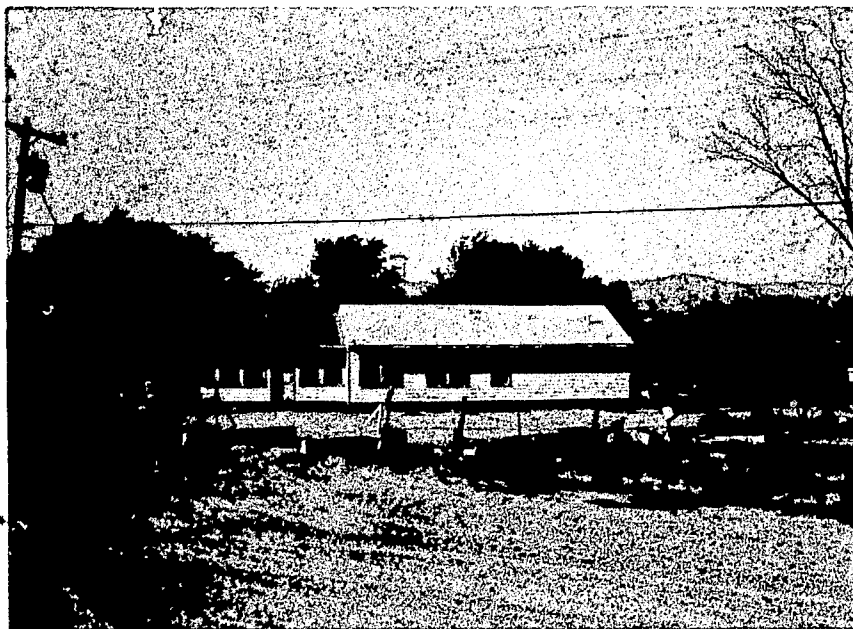

Figure C-5. Bylas Health Center, View to Northeast.



Figure C-6. Bylas Health Center Showing Approximate Site of Proposed Building Addition and Antenna Support.





Figure C-7. Bylas, View to West from Grounds of the Clinic.

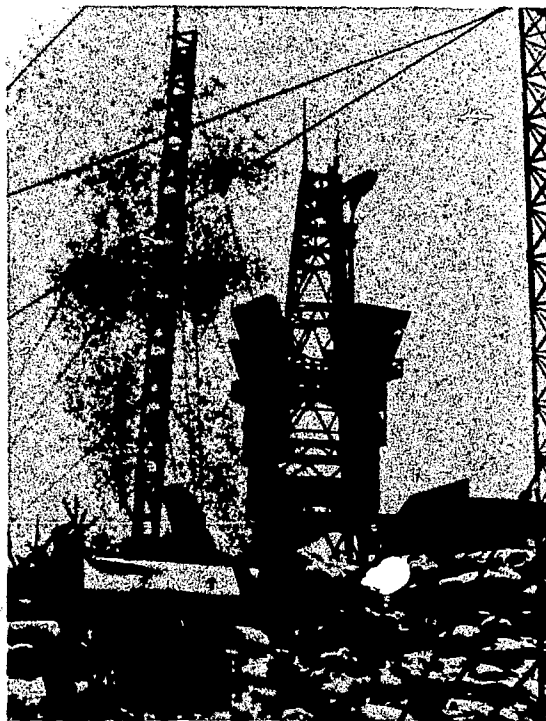

Figure C-8. Pinal Peak BIA Radio Station Shown in Foreground, left of center.



Figure C-9. Pinal Peak, Showing Existing Tower Base and Feed-thru for Transmission Line.

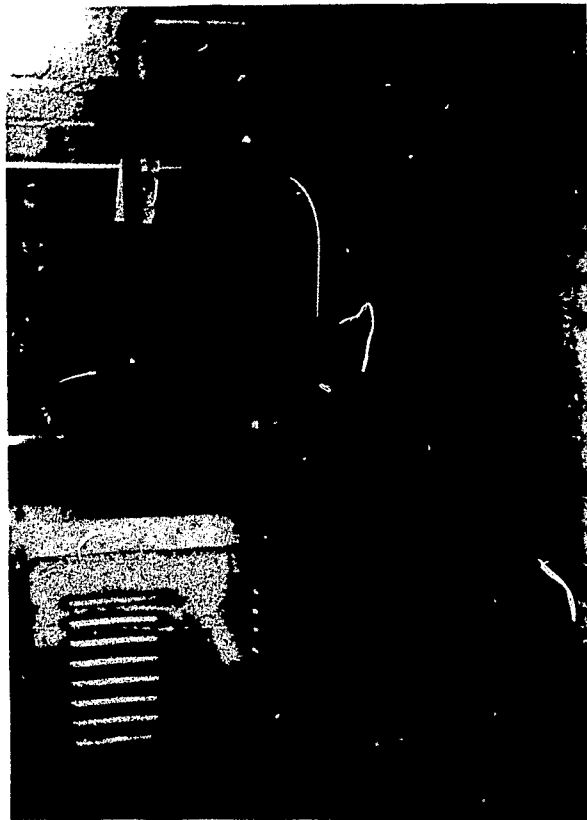

Figure C-10. Pinal Peak Showing the Interior of the Existing BIA Equipment Shelter and Generator (to be removed).

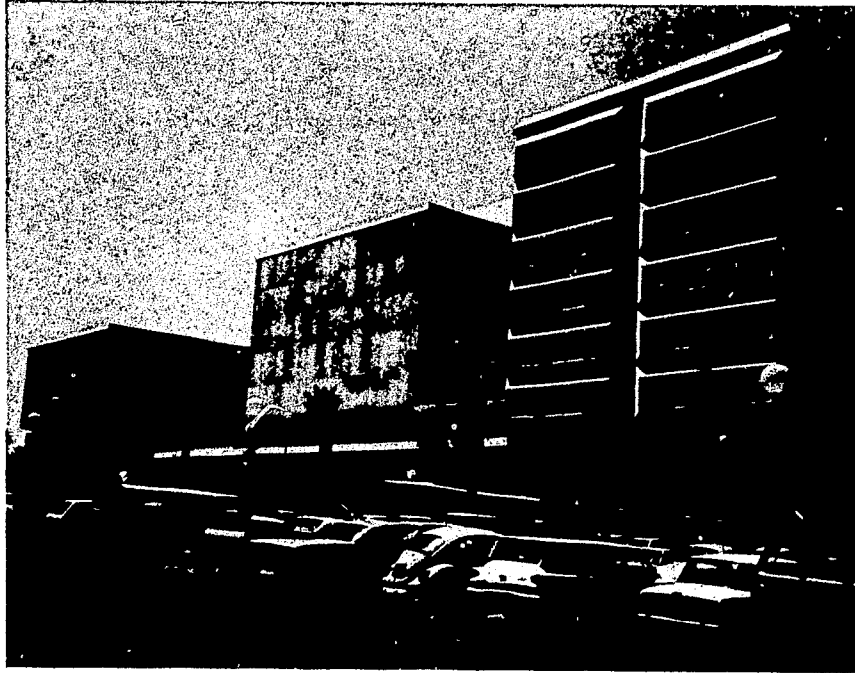

Figure C-11. University of Arizona Medical Center, Tucson.



Figure C-12. View of West Side, University of Arizona Medical Center.

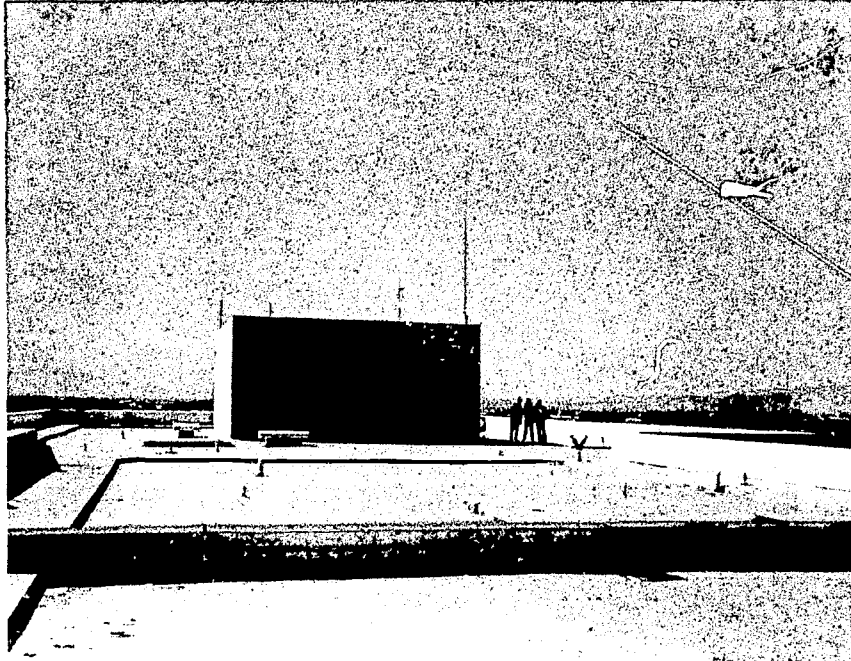

Figure C-13. University of Arizona Medical Center Roof Showing Penthouse. View to the South. Microwave Antenna Proposed Site to Left of Penthouse.

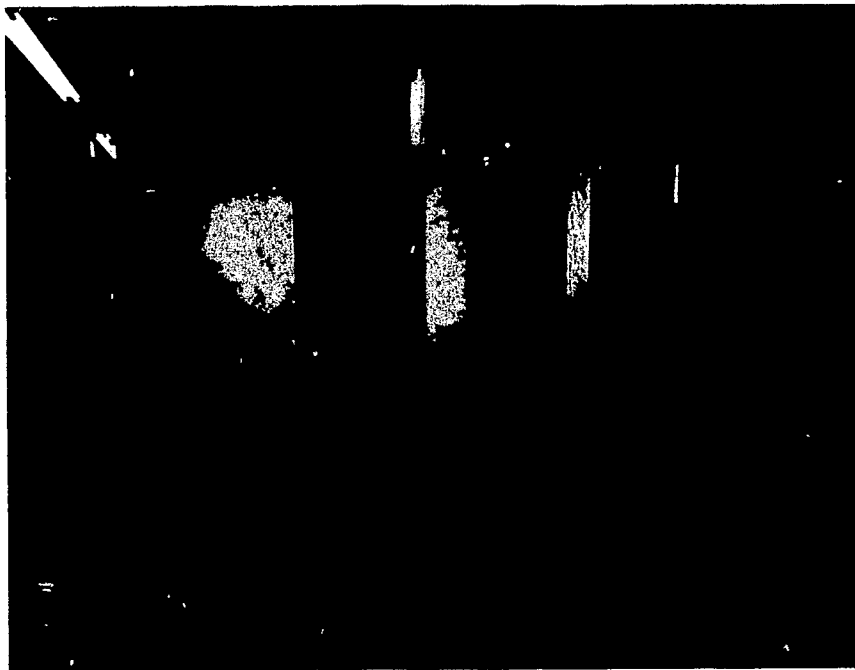

Figure C-14. University of Arizona Medical Center, Showing Proposed Network Equipment Location to the left of the Existing Radio Rack in Penthouse.



Figure C-15. University of Arizona Medical Center Penthouse, Showing Interior View of Southeast Walls and Overhead Cable Tray.

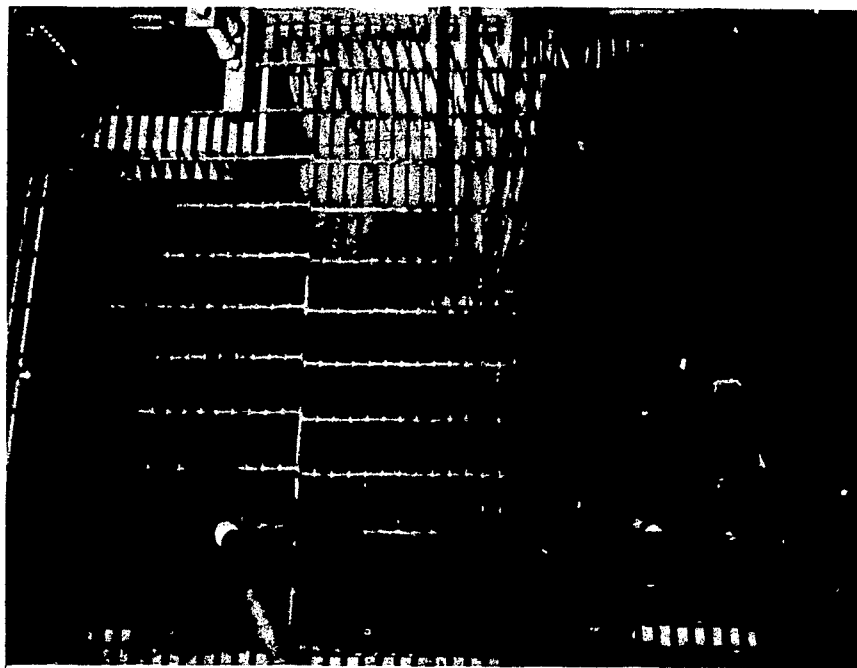

Figure C-16. University of Arizona Medical Center, Showing Cable Chase. View Looking Down from Equipment Area.



Figure C-17. View from the University of Arizona Medical Center Roof Looking West.



Figure C-18. View from the University of Arizona Medical Center Roof Looking South.

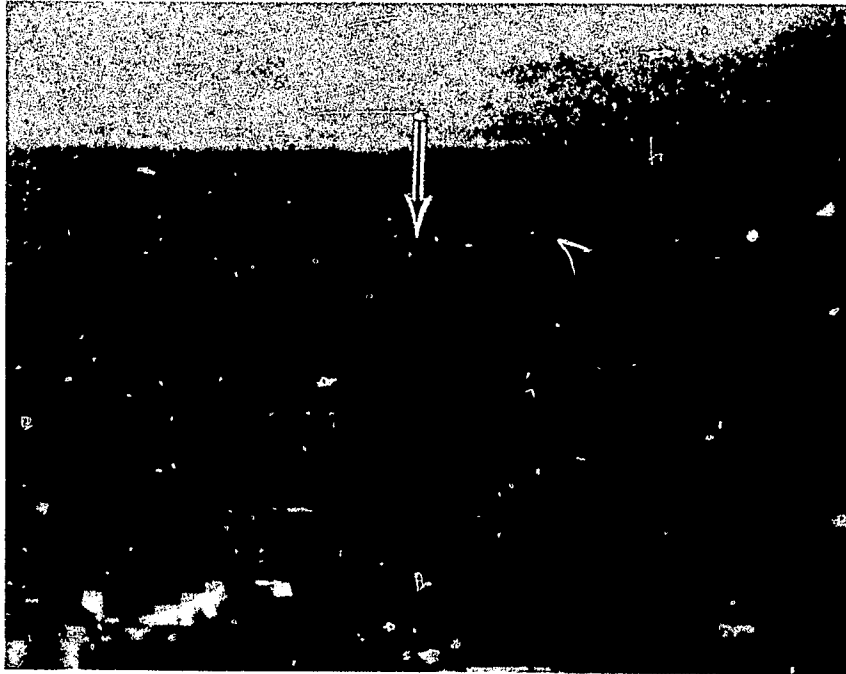

Figure C-19. Telescopic View of HP5C and the Proposed San Xavier Relay Site as seen from the University of Arizona Medical Center Roof.

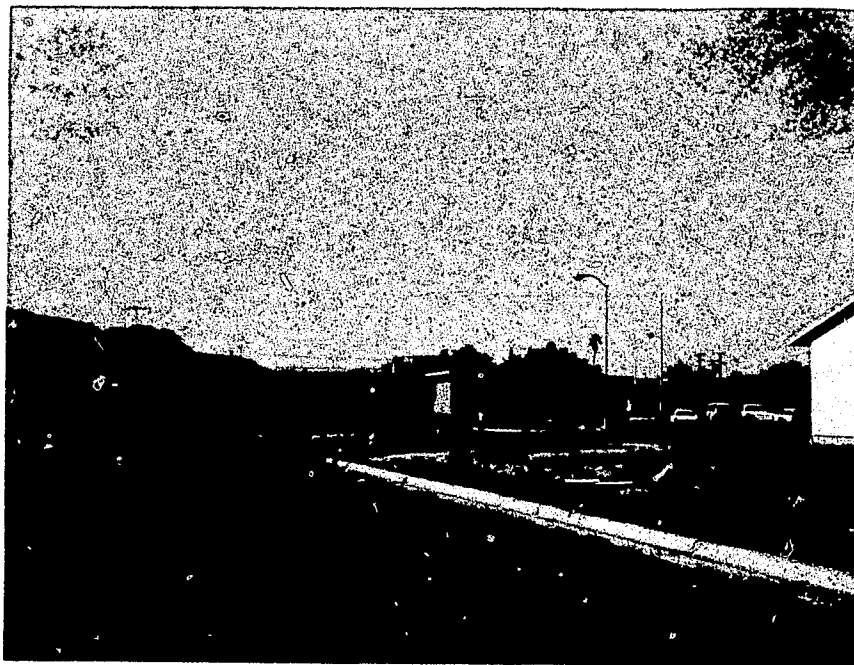
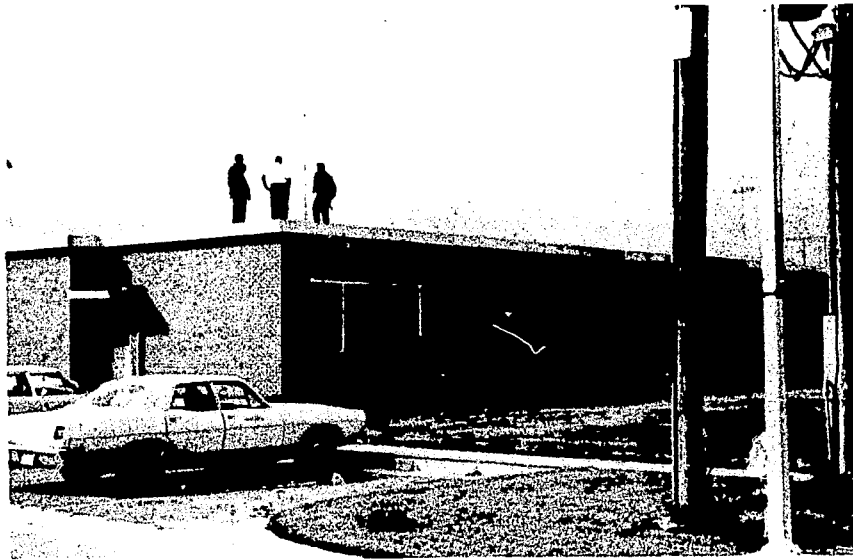

Figure C-20. San Carlos I.H.S. Hospital View Looking North.



**Figure C-21. San Carlos Hospital, Corner of Building Nearest to Teleco Equipment Room and where Tower is to be Located.**



**Figure C-22. San Carlos Hospital Showing Wall in the Teleco Equipment Room where Proposed Microwave Equipment will be Flush Mounted.**



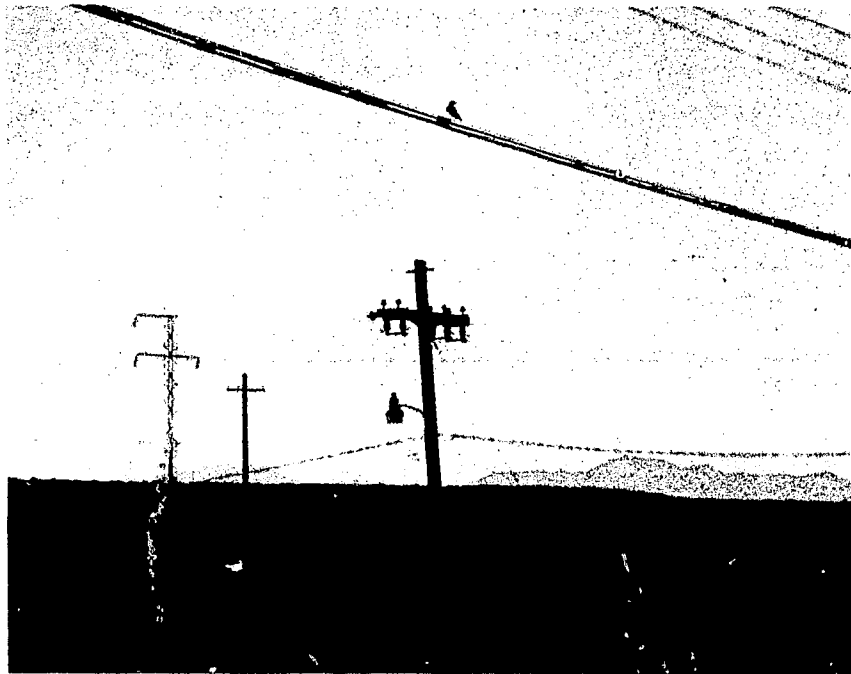

Figure C-23. Pinal Peak, Viewed from San Carlos.



Figure C-24. Sells Hospital, Front View Looking Northwest.

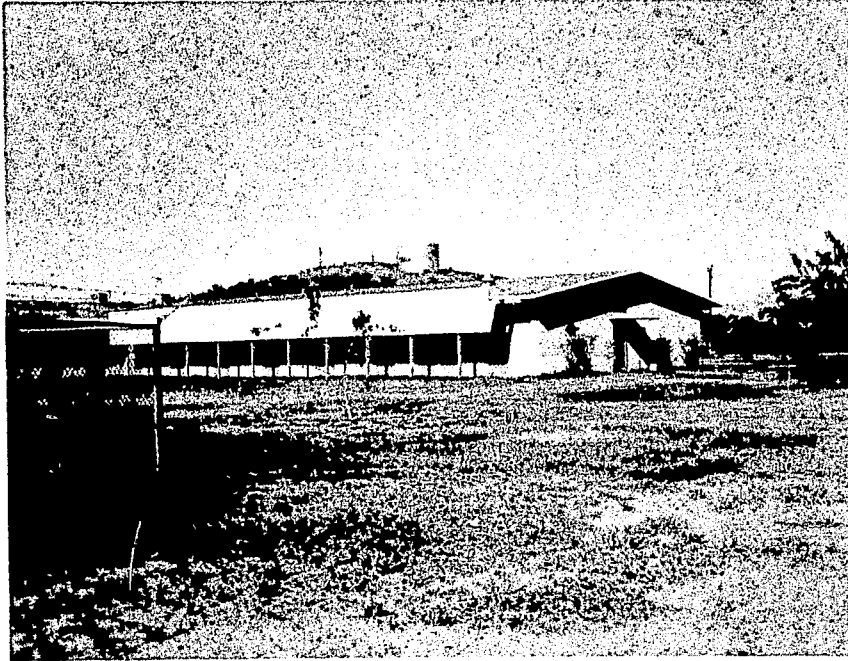

Figure C-25. Sells Hospital, View from Rear Showing Proposed Tower Site Near Center of Hospital Wing.



Figure C-26. Kitt Peak as Viewed from South End of Grounds at Sells Hospital.

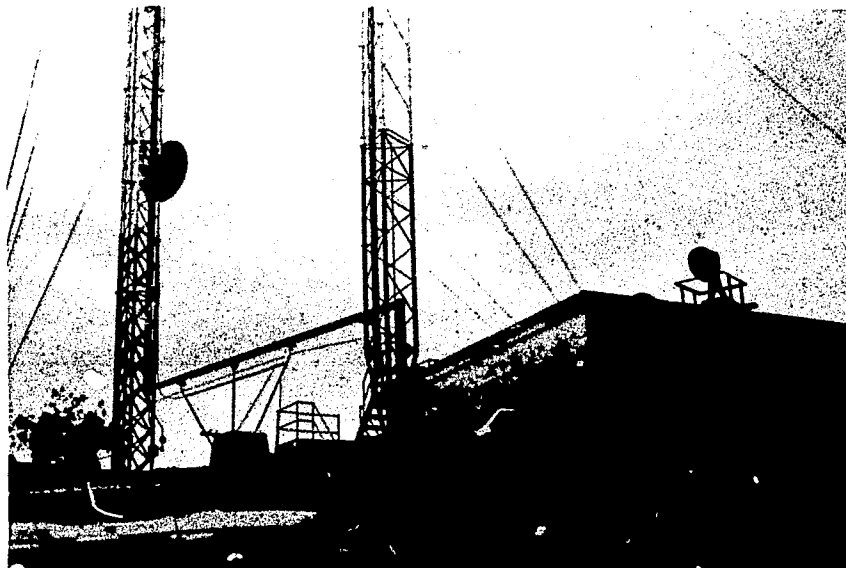

Figure C-27. South Mountain Showing KAET Tower (left) and Equipment Building.

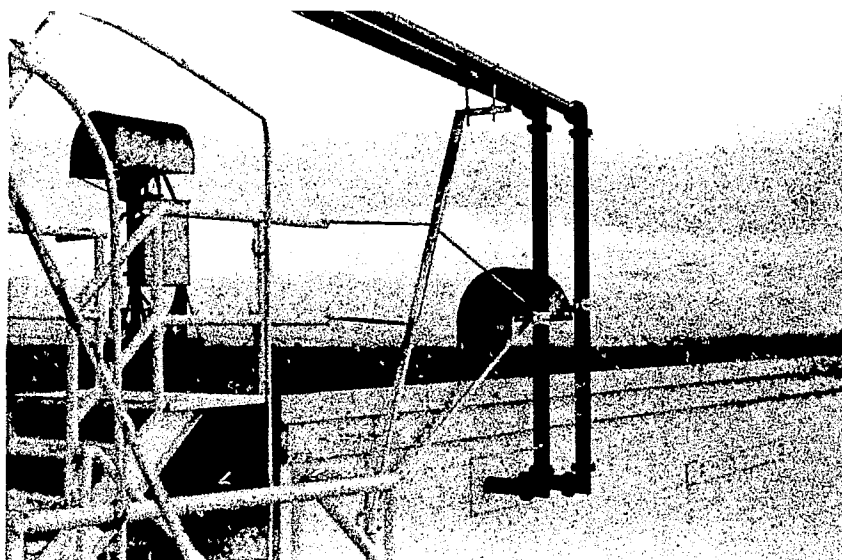

Figure C-28. South Mountain, Showing Roof of KAET Building.



Figure C-29. South Mountain Showing KAET Transmission Line Feedthru, Interior View.



Figure C-30. South Mountain, Showing the Front of the Existing KAET Equipment Racks.



Figure C-31. South Mountain, Showing the Rear of the Existing KAET Equipment Racks.

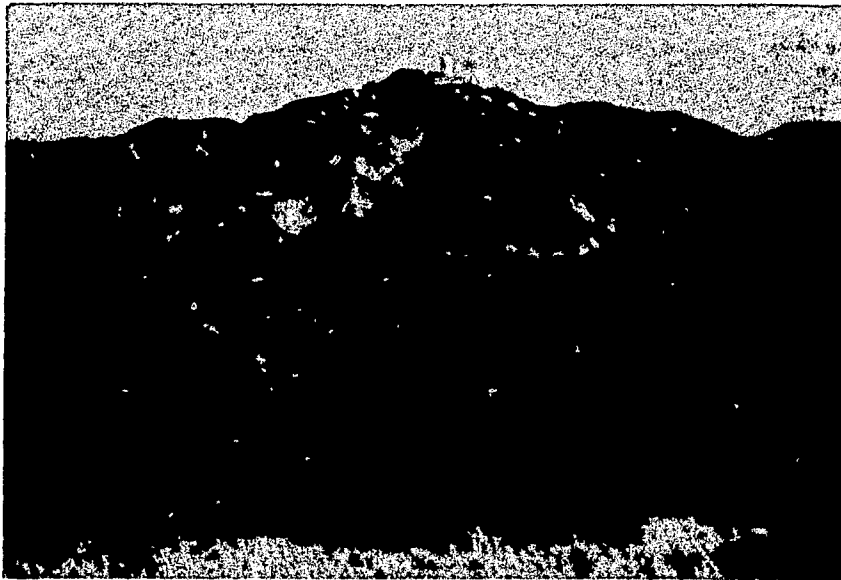

Figure C-32. Kitt Peak, View Looking Southeast.



Figure C-33. Proposed Kitt Peak Relay Site, View Looking East.



Figure C-34. Kitt Peak, View of Proposed Relay Site.



Figure C-35. Kitt Peak Showing Proposed Relay Site at the Left and a Portion of the University's Observatory Compound in the Background, View Looking North.



Figure C-36. Kitt Peak, Showing Underground Power System Vault Near Proposed Microwave Relay Site.



Figure C-37. Kitt Peak, View Toward Tucson from Proposed Relay Site.



Figure C-38. Existing I.H.S. Relay at Kitt Peak (200 yards south of proposed new relay site).





Figure C-39. Pisinimo, Showing the Existing Meeting Hall and Clinic with Proposed Relay Site in Foreground.

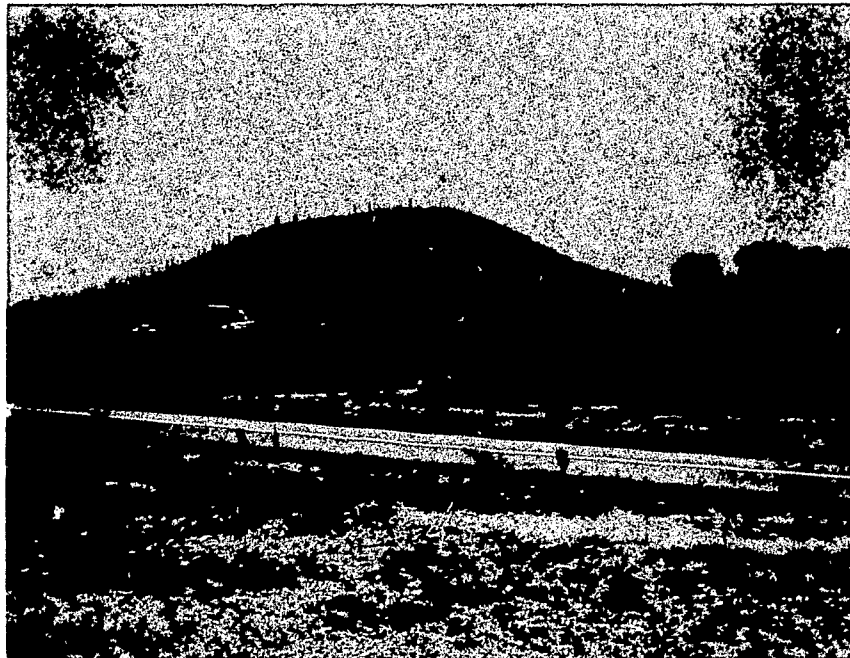

Figure C-40. Health Program Systems Center Near San Xavier Mission. View to West.



Figure C-41. Health Program Systems Center, Near San Xavier Mission. West Side of Building.



Figure C-42. Kitt Peak as Viewed from Proposed Antenna Site Near Health Program Systems Center.

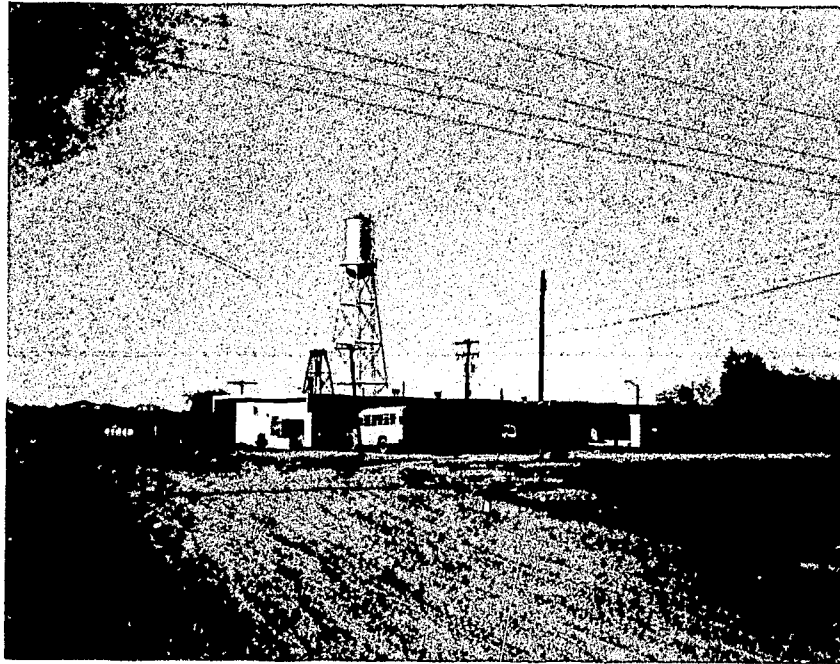

Figure C-43. Santa Rosa Health Center, Looking North.

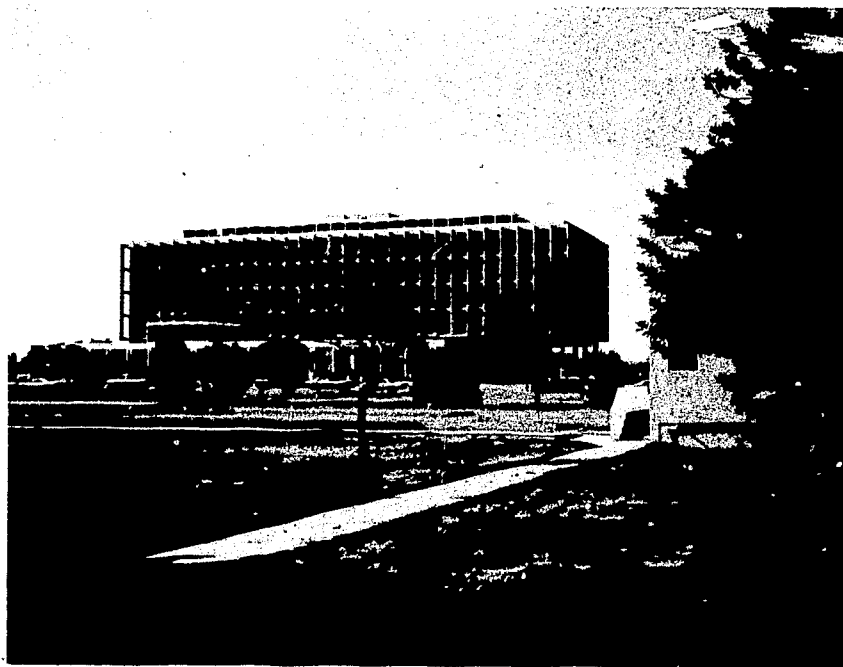

Figure C-44. Phoenix Indian Medical Center.

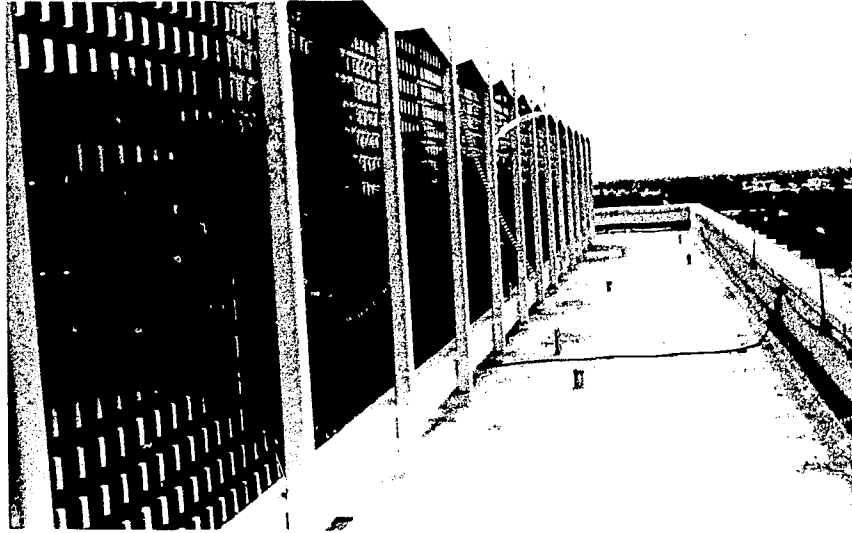

Figure C-45. Phoenix Indian Medical Center Roof Showing Lightning Rod Ground System and Grillwork Surrounding the Penthouse.



Figure C-46. Phoenix Indian Center Roof Area Adjacent to Penthouse, Site of Proposed Prefabricated Equipment Shelter. Air Duct Shown in Center.

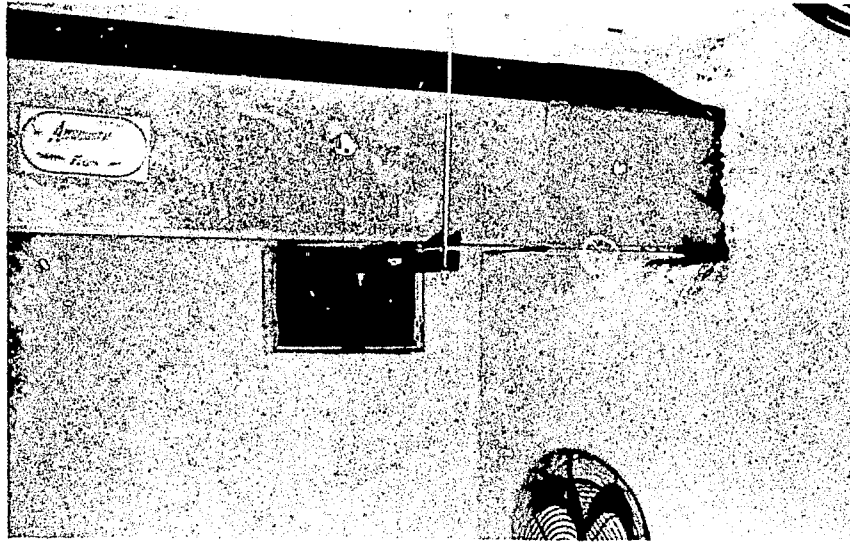

Figure C-47. Phoenix Indian Medical Center, Elevator Equipment Room Showing Proposed Cable Route from Elevator Shaft (access hole seen in center of photo) Paralled with Existing Duct thru Outer Wall (to the right).

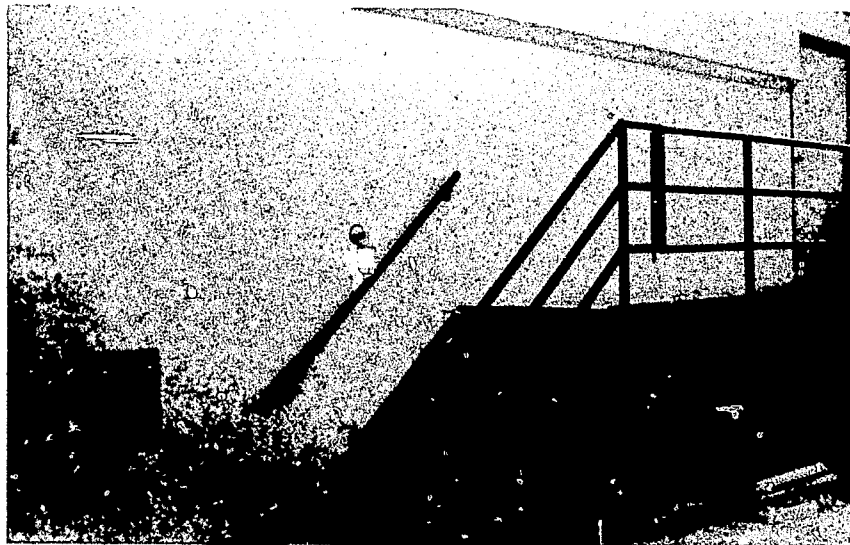

Figure C-48. Phoenix Indian Center, Exterior View of Elevator Equipment Room, Showing Cable Feedthru Near Duct Port, Lower Left.

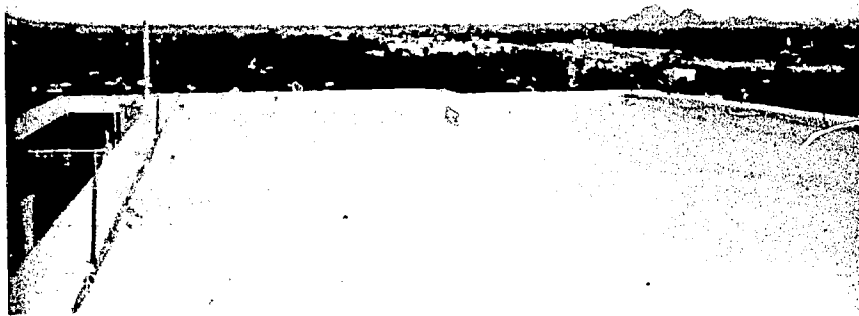

Figure C-49. Phoenix Indian Medical Center Elevator Equipment Room Roof. View Looking West. Top of Penthouse.



Figure C-50. Phoenix Indian Medical Center, Showing Approximate Location of Proposed Control Console.

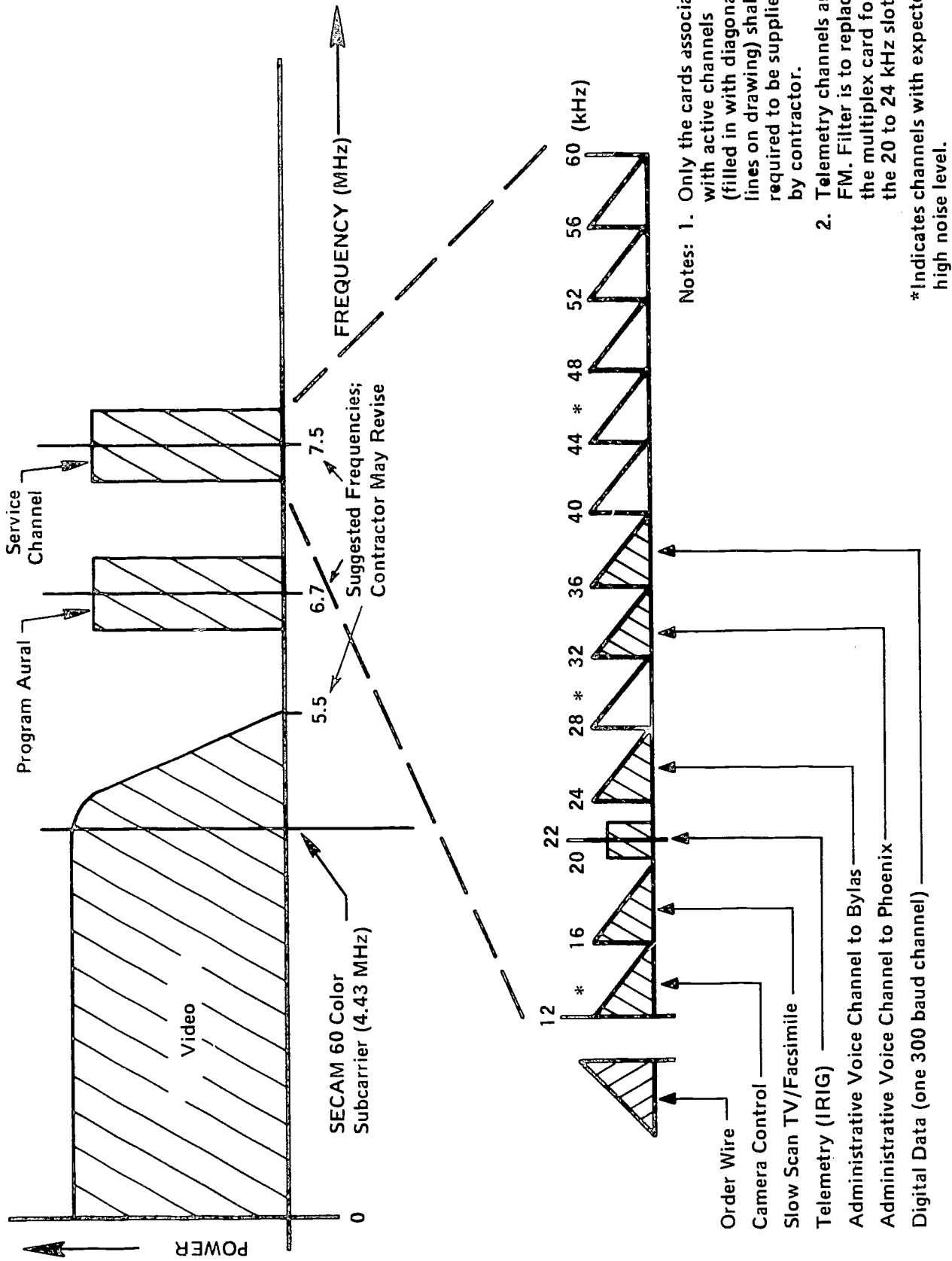

Figure C-51. Phoenix Indian Medical Center, Showing Proposed Monitor and Camera Mounting Positions.

**APPENDIX D**

**DRAWINGS**





- Notes:
1. Only the cards associated with active channels (filled in with diagonal lines on drawing) shall be required to be supplied by contractor.
  2. Telemetry channels are FM. Filter is to replace the multiplex card for the 20 to 24 kHz slot.
- \*Indicates channels with expected high noise level.

Figure D.1. Channelization Plan, Link from San Carlos to Pinal Peak.

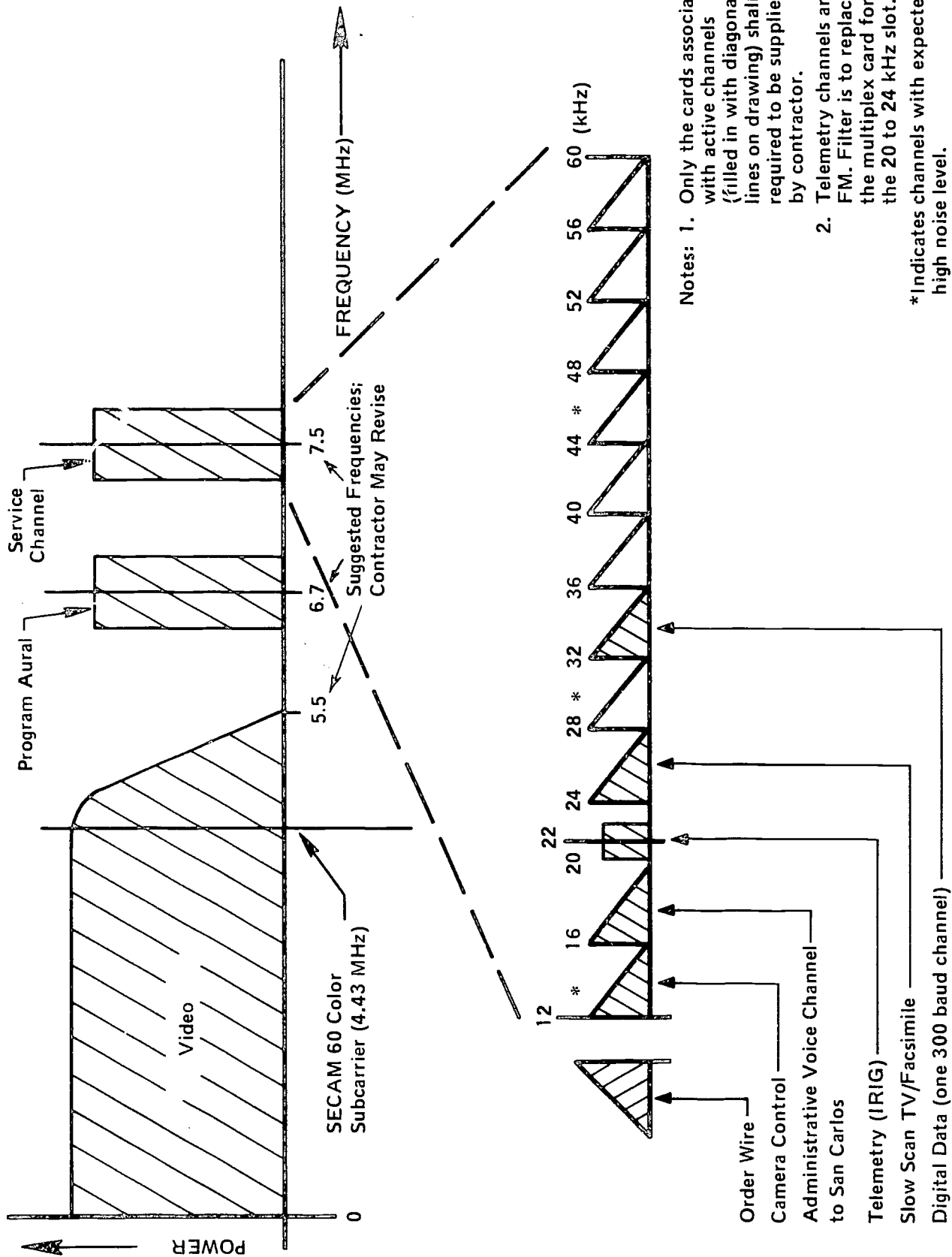

- Notes:
1. Only the cards associated with active channels (filled in with diagonal lines on drawing) shall be required to be supplied by contractor.
  2. Telemetry channels are FM. Filter is to replace the multiplex card for the 20 to 24 kHz slot.
- \* Indicates channels with expected high noise level.

Figure D.2. Channelization Plan, Link from Bylas to Pinal Peak.

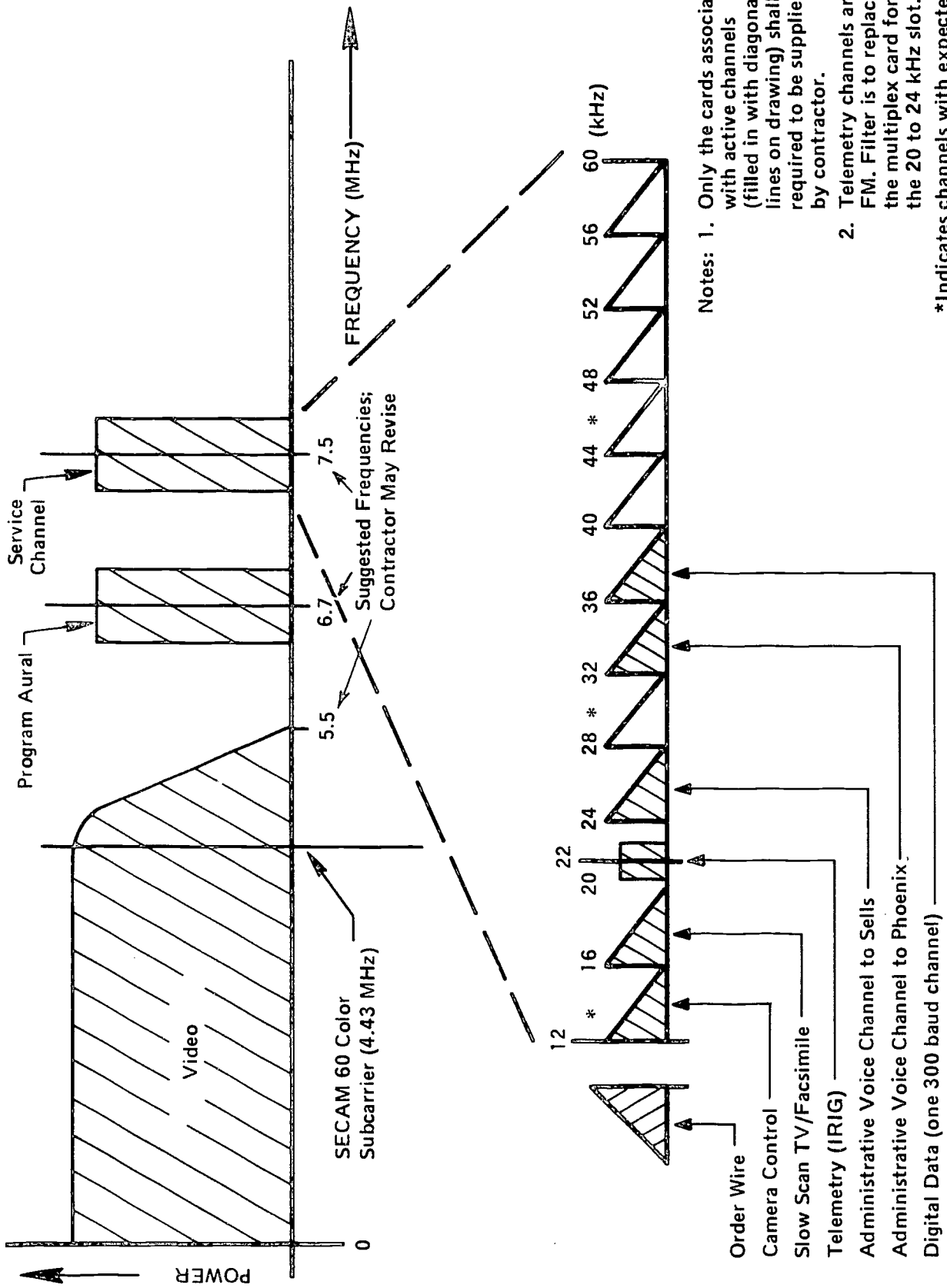

- Notes:
1. Only the cards associated with active channels (filled in with diagonal lines on drawing) shall be required to be supplied by contractor.
  2. Telemetry channels are FM. Filter is to replace the multiplex card for the 20 to 24 kHz slot.
- \*Indicates channels with expected high noise level

Figure D.3. Channelization Plan, Link from University of Arizona to San Xavier.

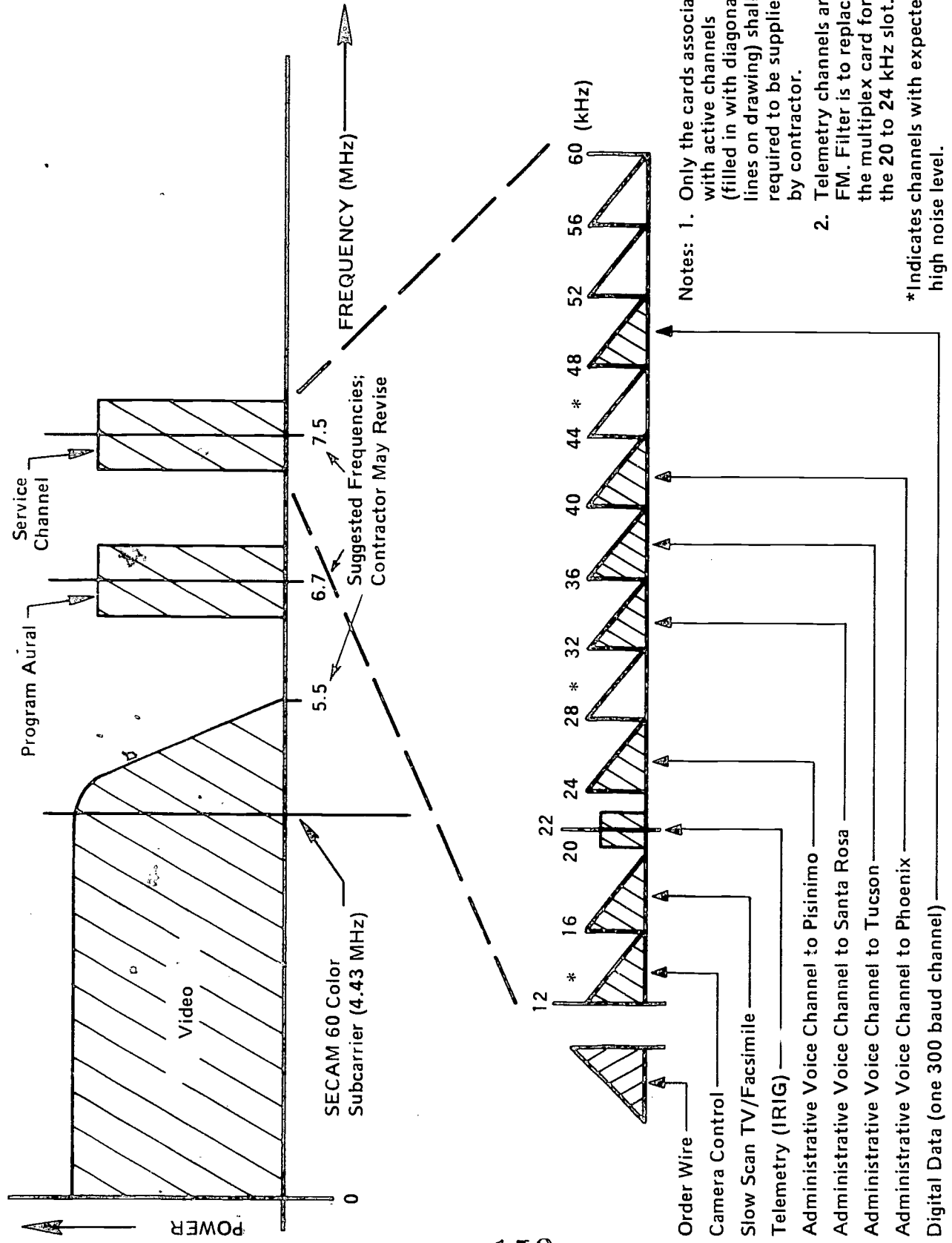
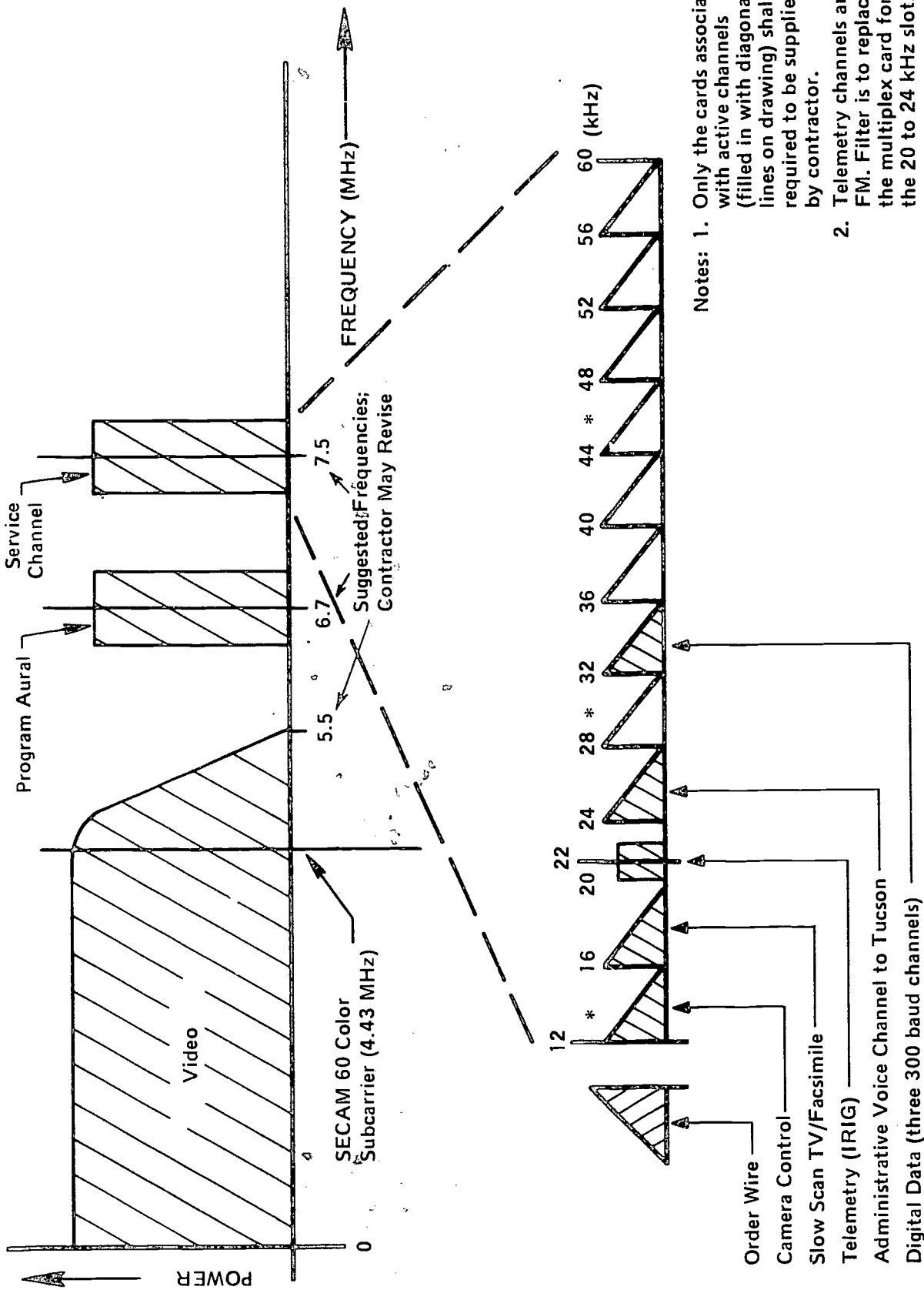
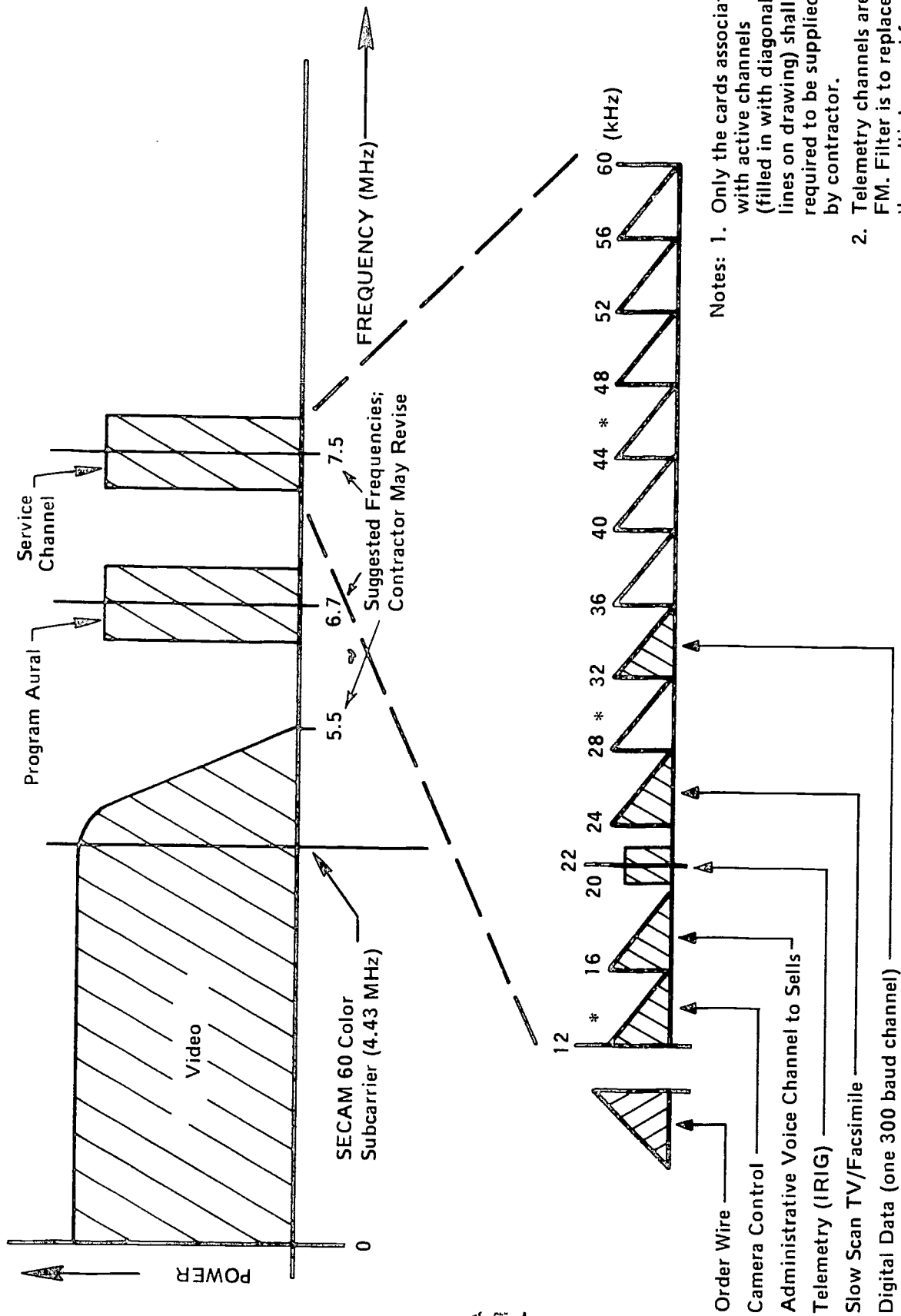

Figure D.4. Channelization Plan, Link from Sells to Kitt Peak.



- Notes:
1. Only the cards associated with active channels (filled in with diagonal lines on drawing) shall be required to be supplied by contractor.
  2. Telemetry channels are FM. Filter is to replace the multiplex card for the 20 to 24 kHz slot.
- \* Indicates channels with expected high noise level.

Figure D.5. Channelization Plan, Link from Kitt Peak to San Xavier.



- Notes:
1. Only the cards associated with active channels (filled in with diagonal lines on drawing) shall be required to be supplied by contractor.
  2. Telemetry channels are FM. Filter is to replace the multiplex card for the 20 to 24 kHz slot.
- \*Indicates channels with expected high noise level.

Figure D.6. Channelization Plan, Link from Santa Rosa (Gu Achi) to Kitt Peak.

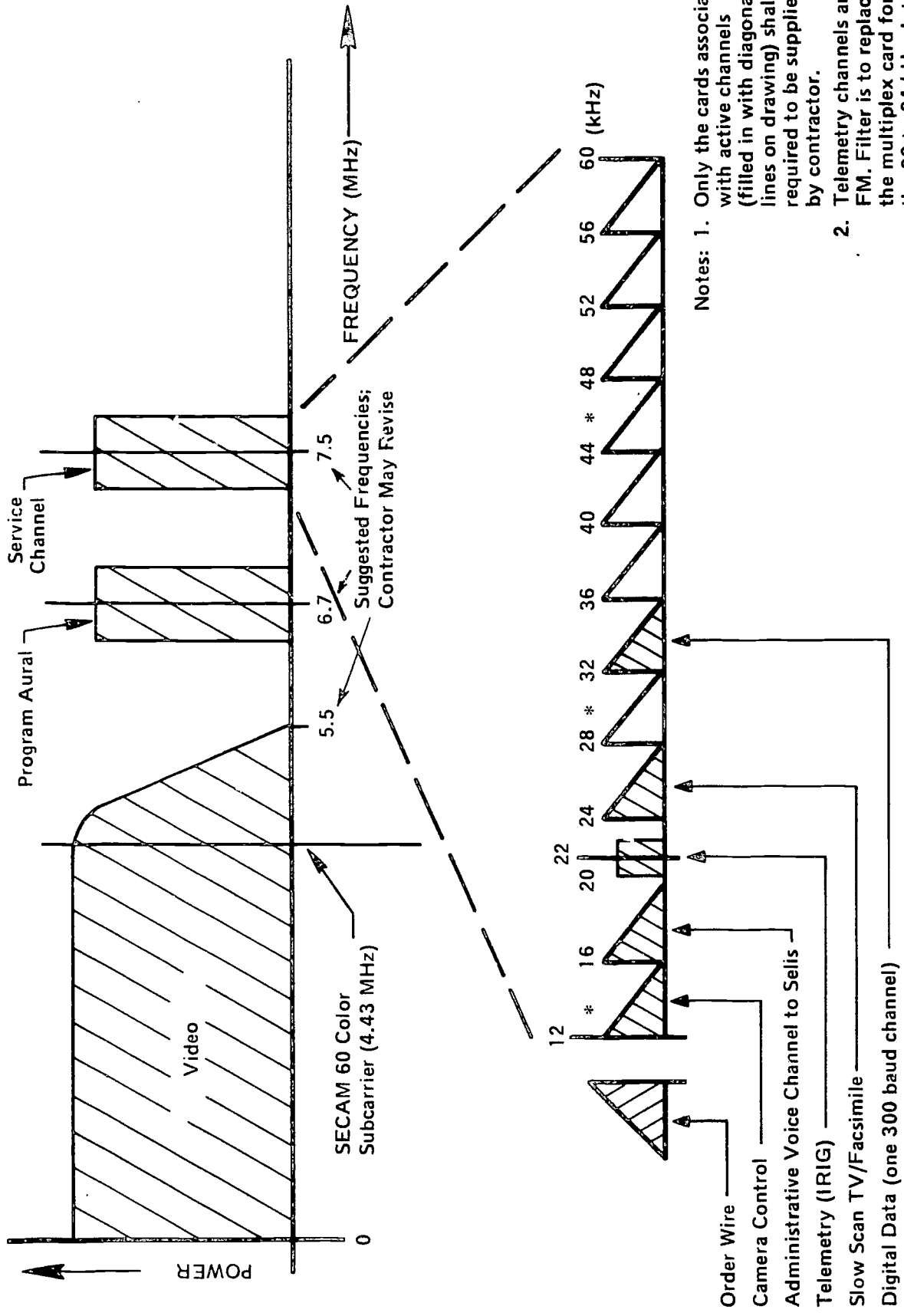

- Notes:
1. Only the cards associated with active channels (filled in with diagonal lines on drawing) shall be required to be supplied by contractor.
  2. Telemetry channels are FM. Filter is to replace the multiplex card for the 20 to 24 kHz slot.
- \*Indicates channels with expected high noise level.

Figure D.7. Channelization Plan, Link from Pisimino to Kitt Peak.

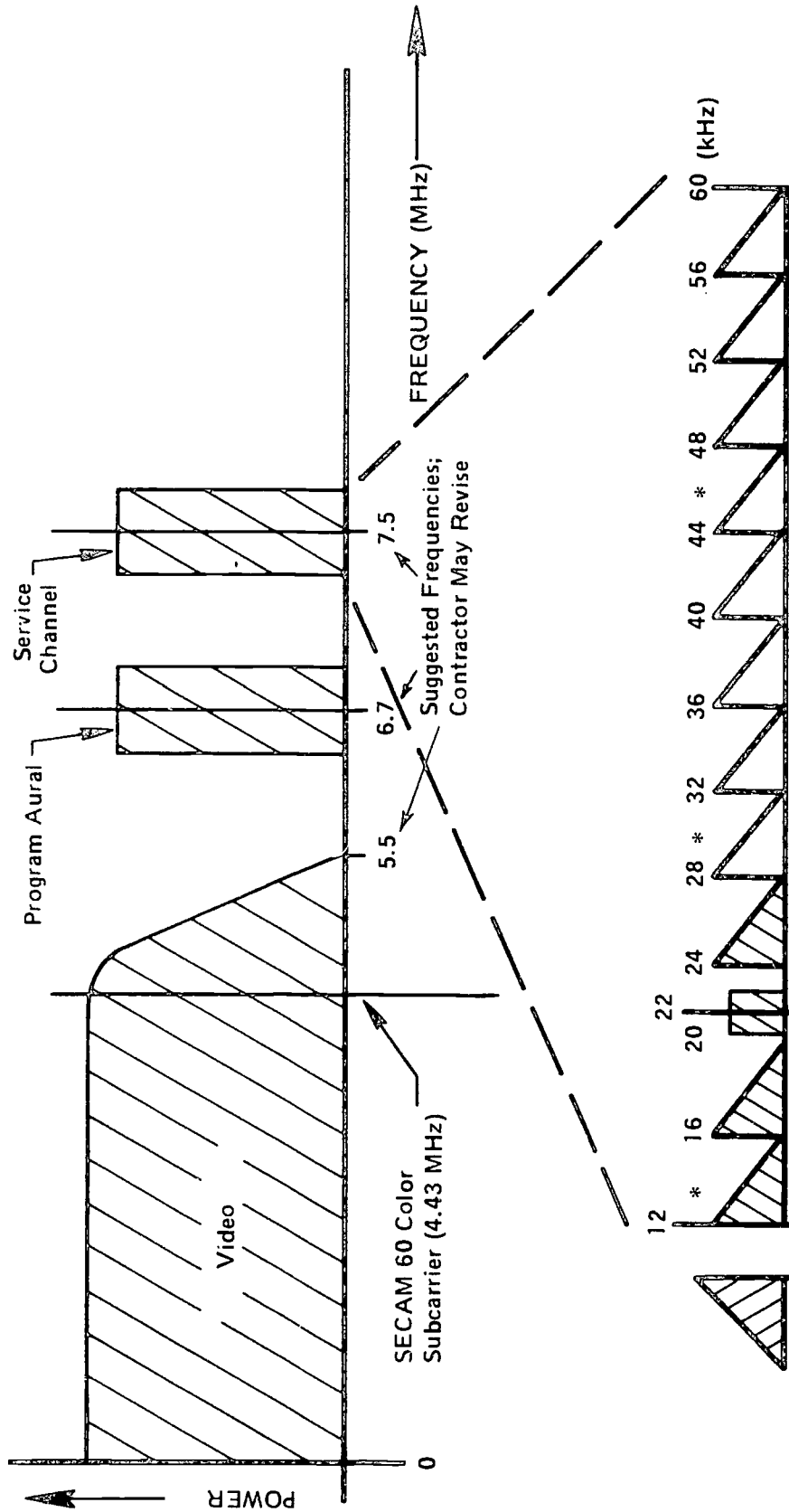

Notes: 1. Only the cards associated with active channels (filled in with diagonal lines on drawing) shall be required to be supplied by contractor.

2. Telemetry channels are FM. Filter is to replace the multiplex card for the 20 to 24 kHz slot.

\*Indicates channels with expected high noise level.

- Order Wire
- Camera Control
- Administrative Voice Channel from Sells to Phoenix
- Telemetry (IRIG)
- Slow Scan TV/Facsimile

Figure D.8. Channelization Plan, Link from Kitt Peak to Phoenix through Relays at Cimarron and South Mountain.



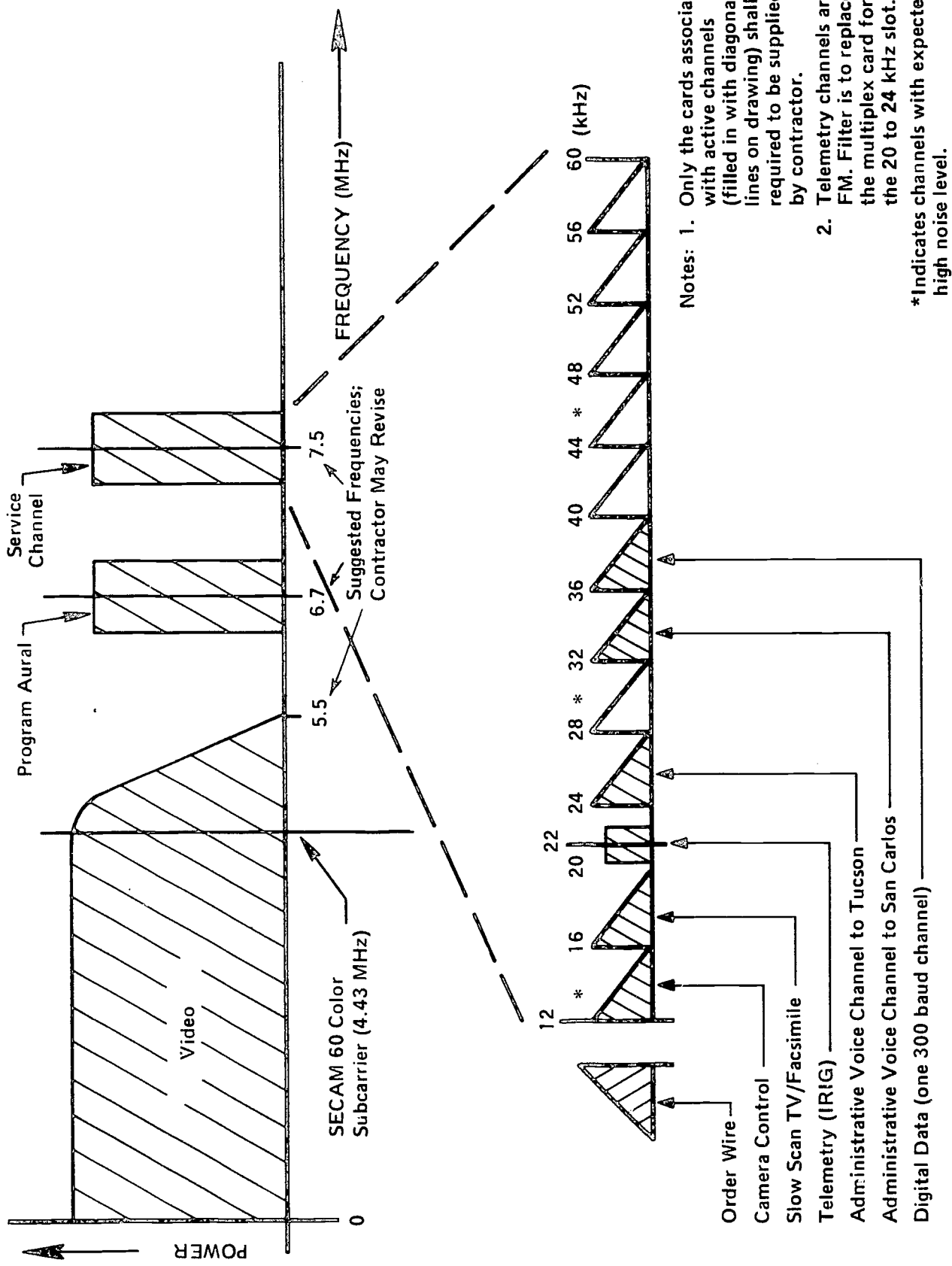

Figure D.9. Channelization Plan, Link from Phoenix to Pinal Peak.

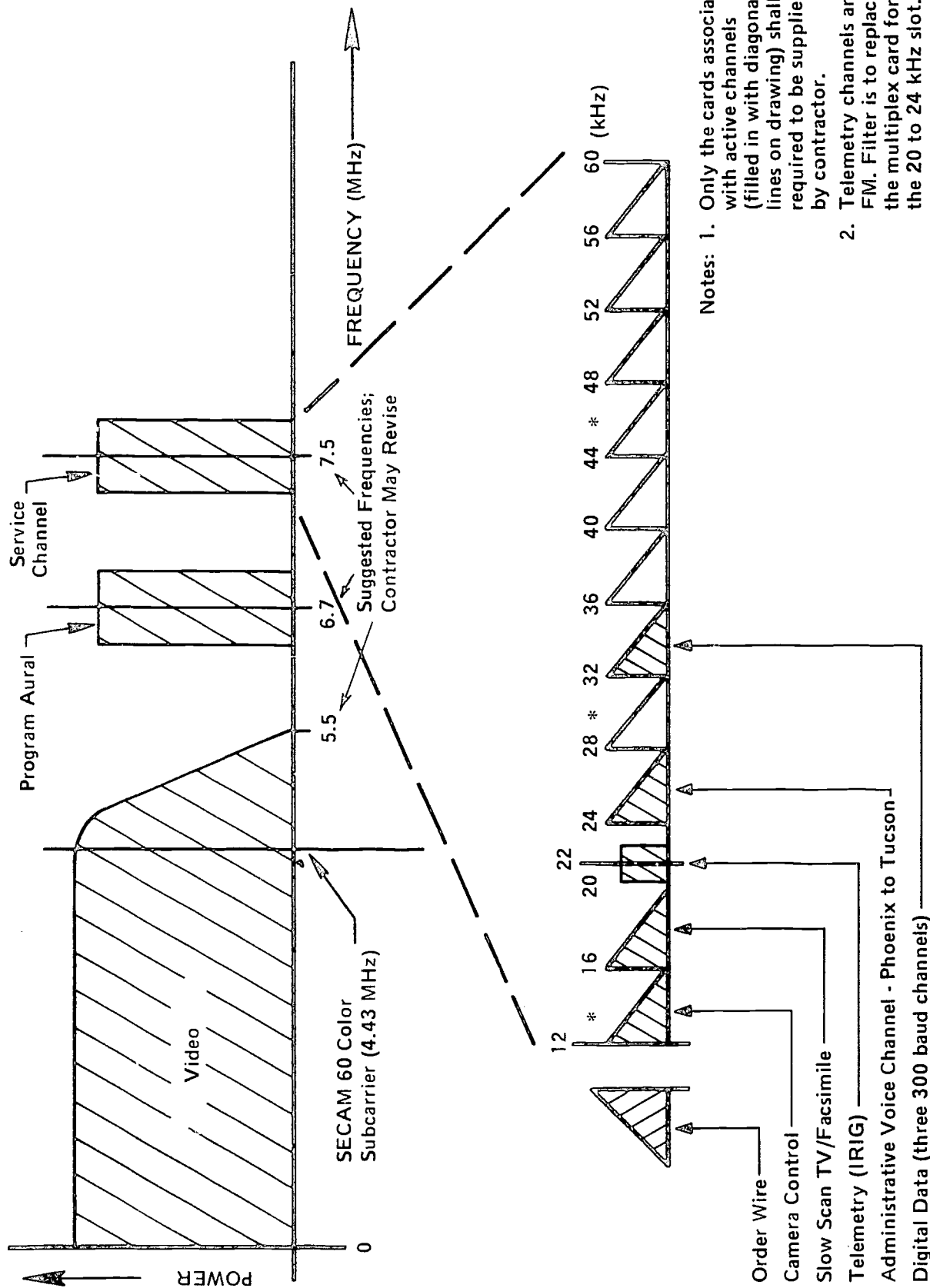

Figure D.10. Channelization Plan, Link from Pinal Peak to San Xavier via Mt. Lemmon.

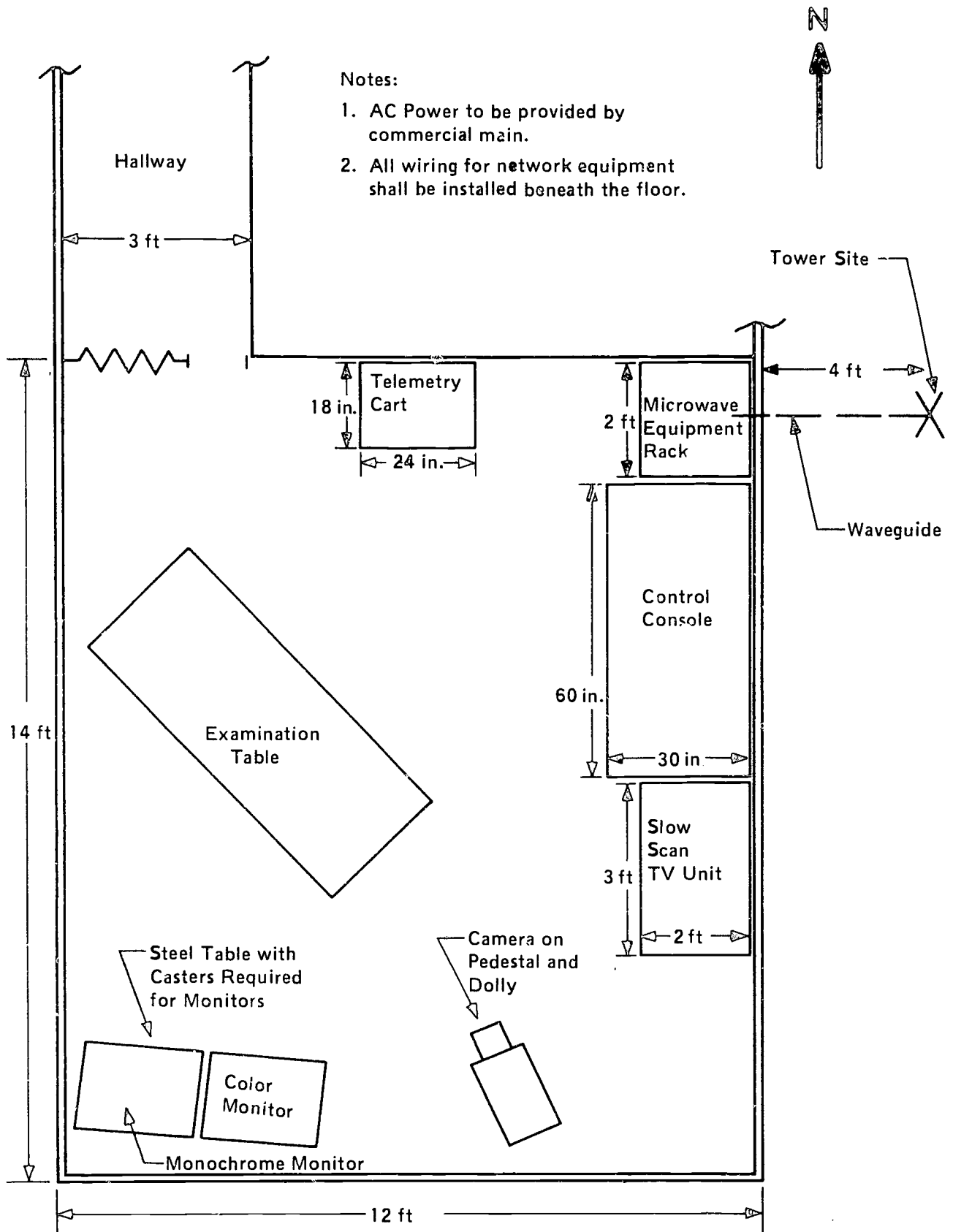
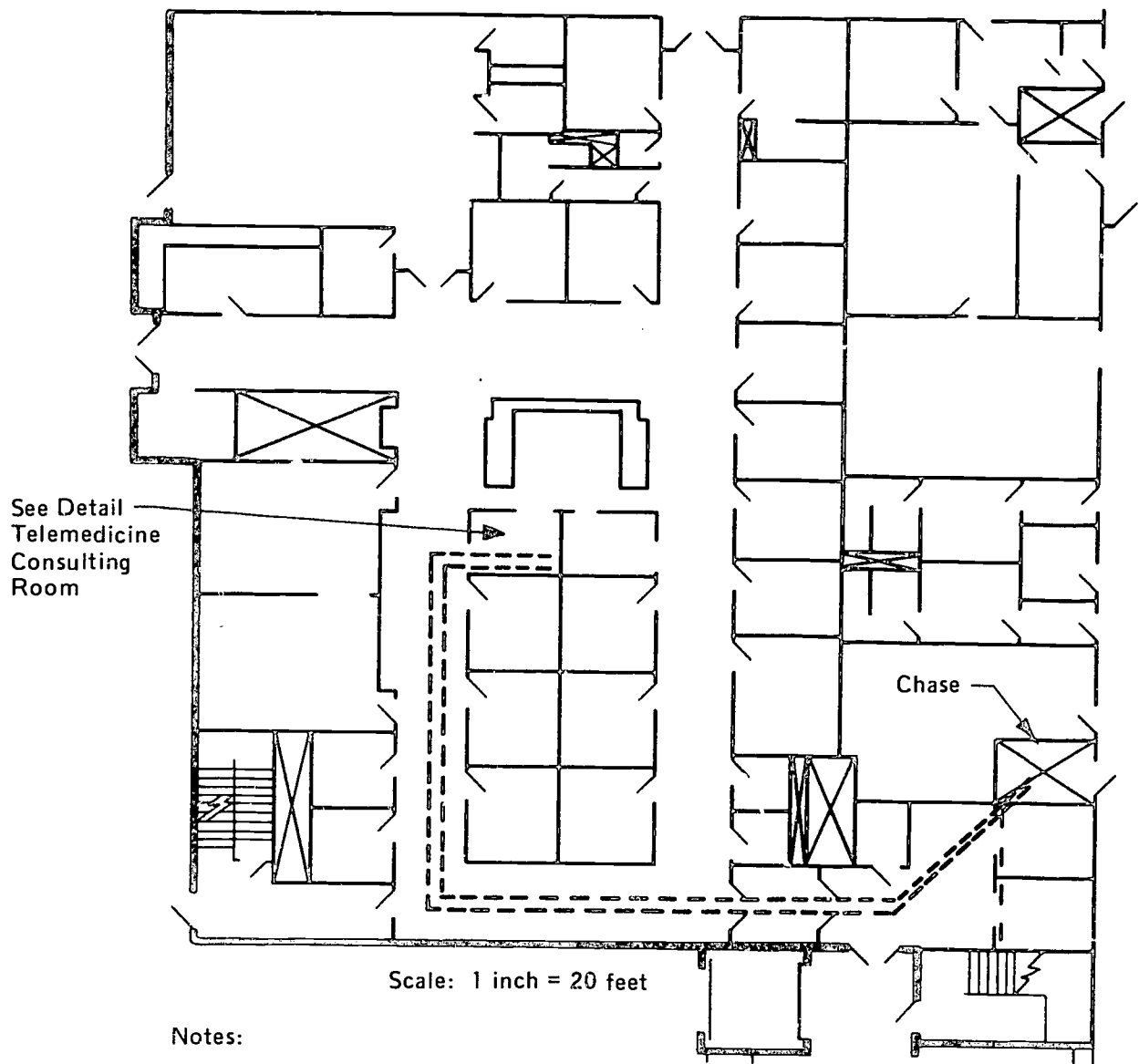

Figure D.11. Proposed Facilities, Bylas Field Health Station.



Notes:

1. The 2 inch conduit required between the first floor and second floor sites will be installed by the Physical Resources Department staff under contract with the Telemedicine Project Contractor. With the conduit, the Physical Resources Department staff will install three (3) coaxial cables (Belden 9231 or equivalent) and a single, multiple pair cable (Belden 9775 or equivalent).
2. The 2 inch conduit required between the first floor site and the penthouse will be installed by the Physical Resources Department staff under contract with the Telemedicine Project Contractor. Also installed by the same group will be four coaxial cables (Belden 9231 or equivalent) and a six pair audio cable.
3. All cable will be supplied by the Telemedicine Contractor.
4. All required AC power outlets and/or connector boxes will be supplied by the Physical Resources Department.
5. Vertical distance from the penthouse to the first floor is approximately 140 feet. First floor to second floor is approximately 14 feet.

Figure D.12. First Floor, University of Arizona Medical Center, Proposed Conduit and Cable Runs.

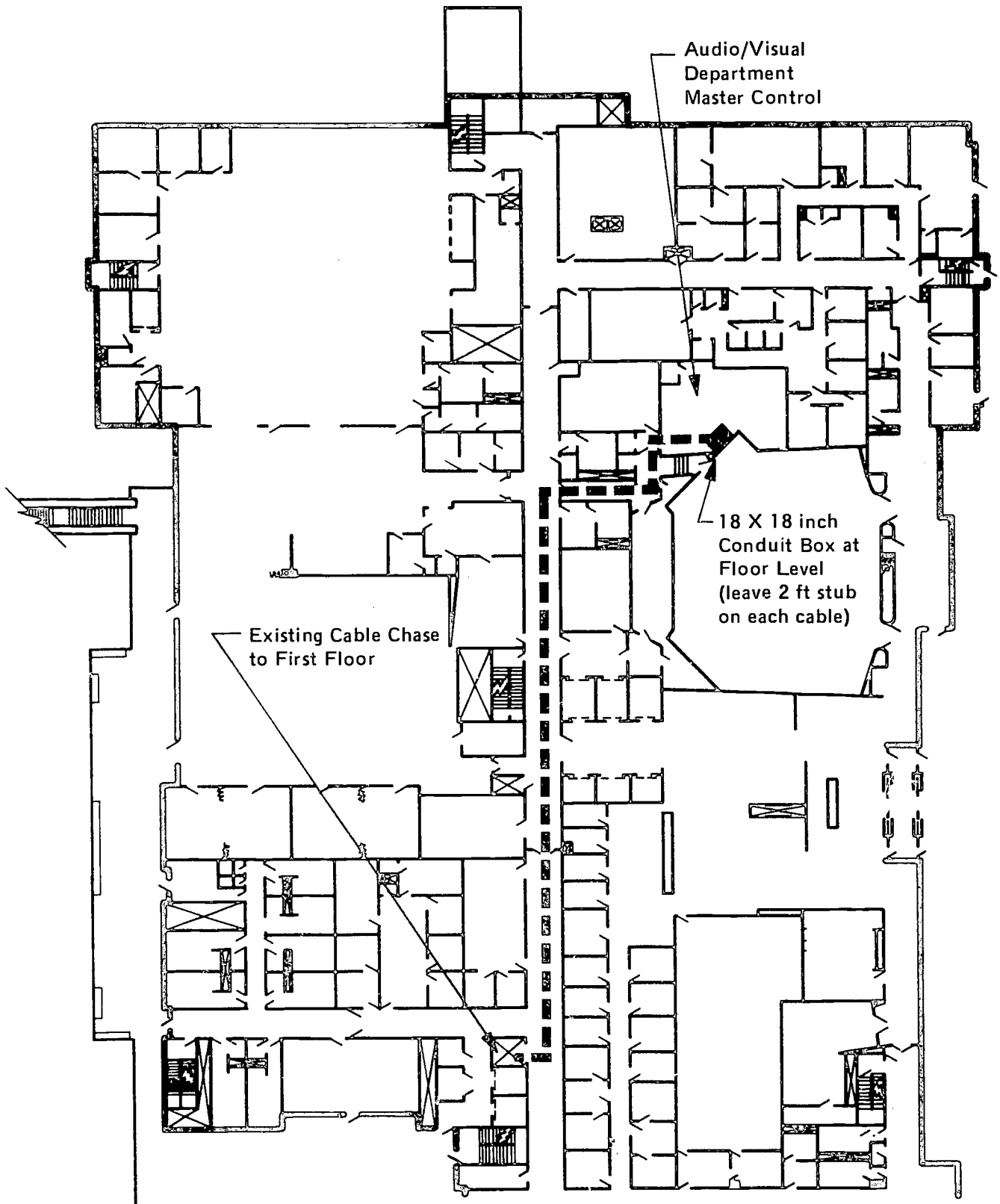

Figure D.13. Second Floor, University of Arizona Medical Center, Proposed Conduit and Cable Run.

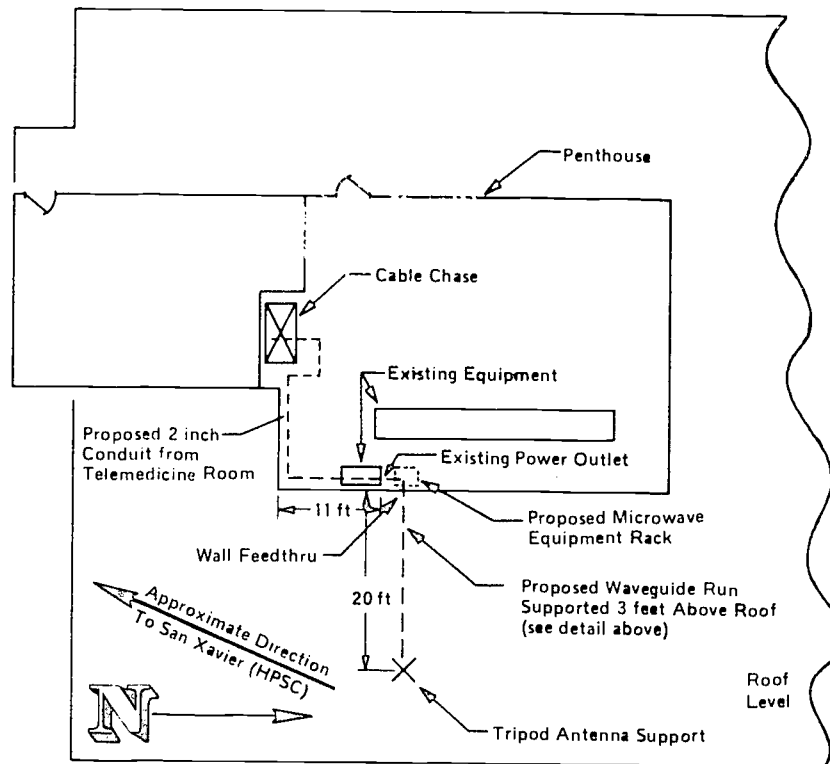
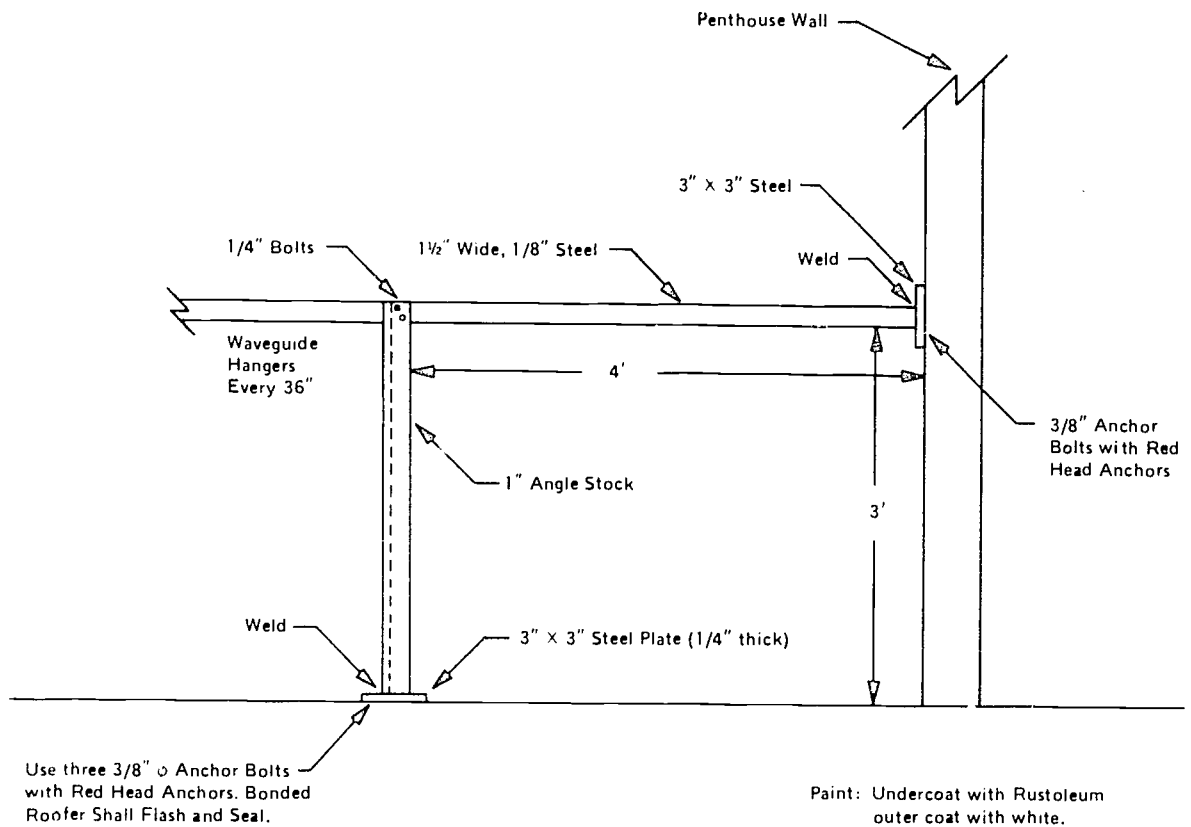

Figure D.14. Penthouse Level, University of Arizona Medical Center, Existing and Proposed Facilities.

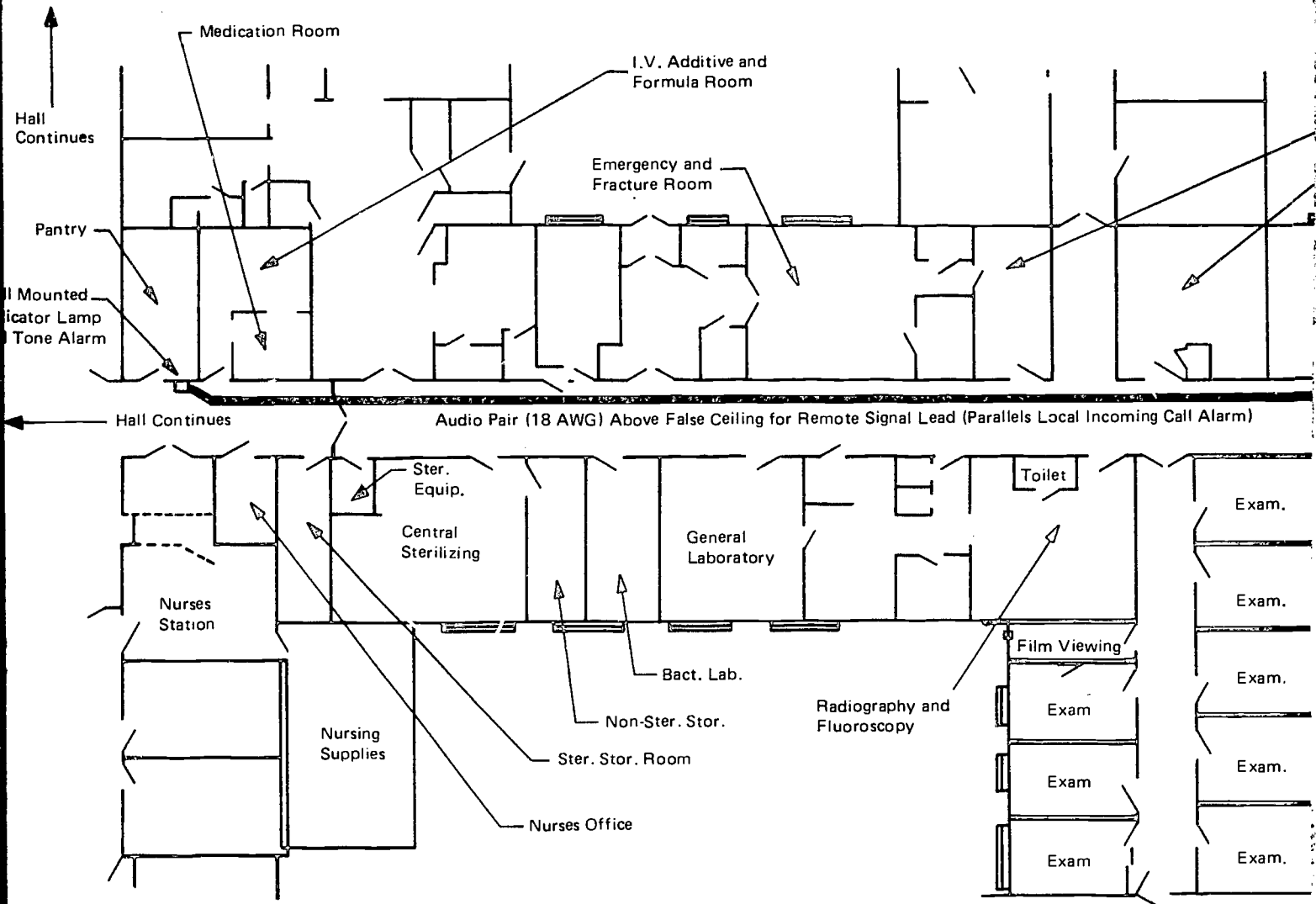

Figure D. 15. Existing and Proposed Facilities, San Carlos Hospital. Page #1

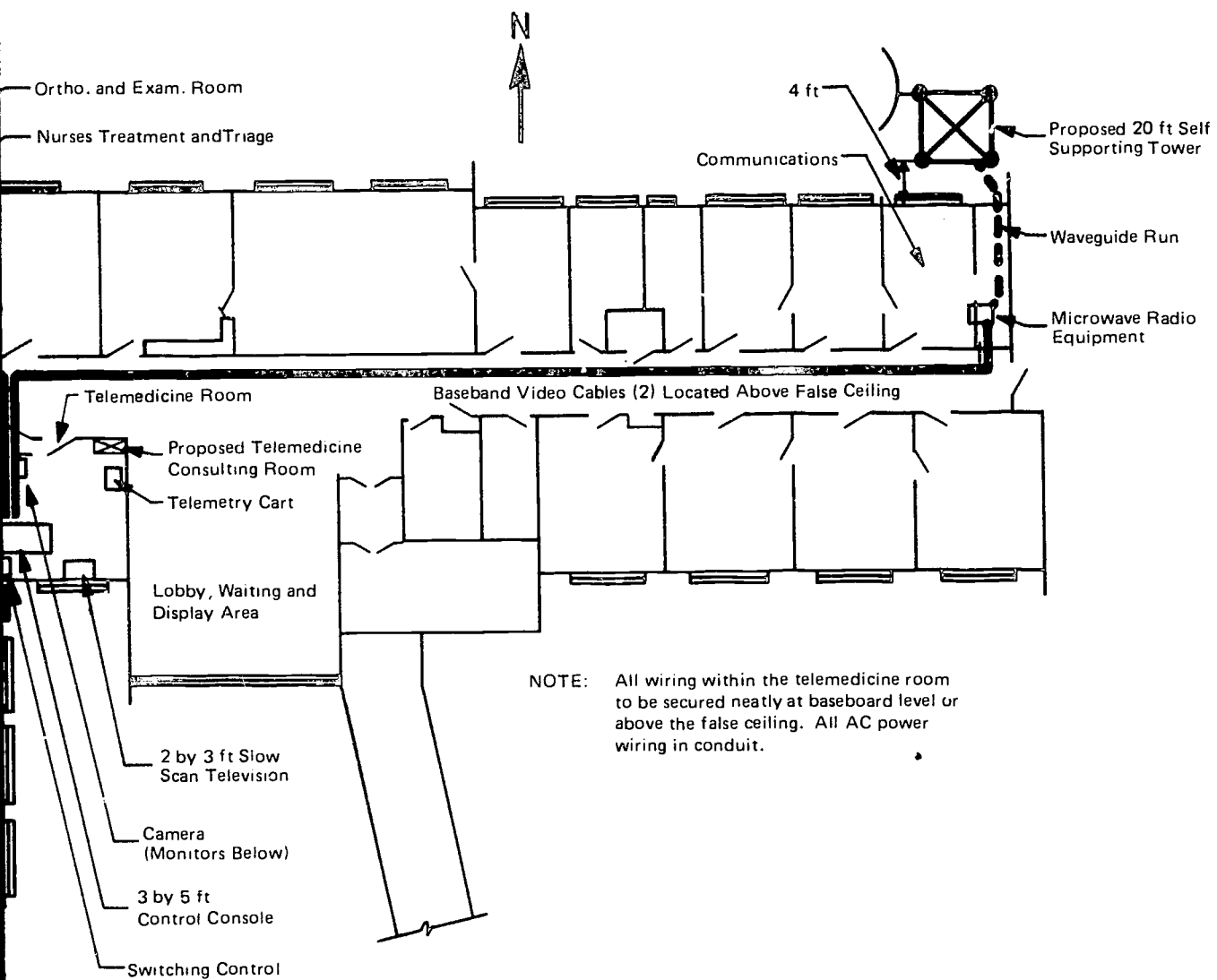

Figure D.15. Existing and Proposed Facilities, San Carlos Hospital.

Page #2



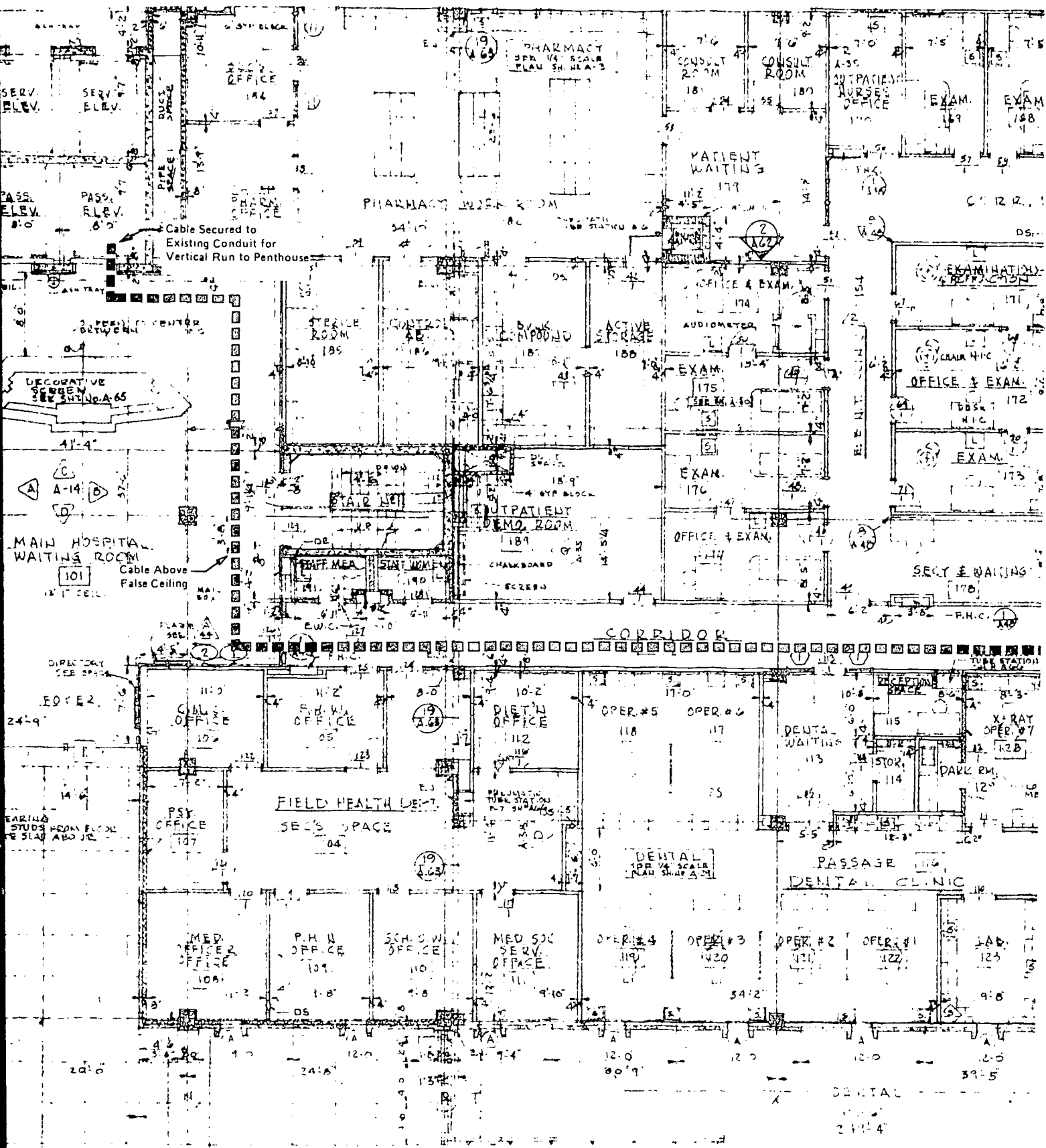
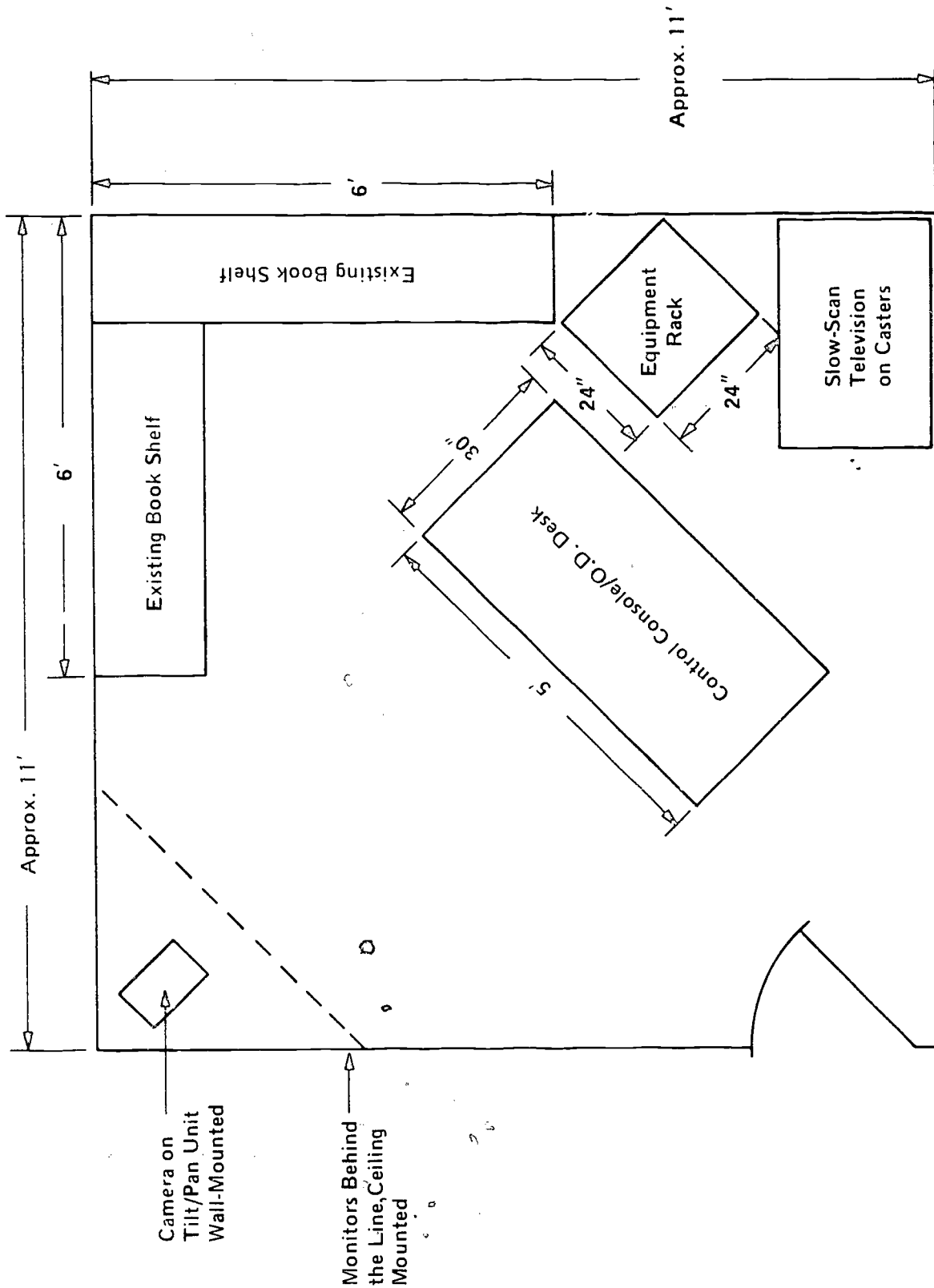

Figure D. 16. Existing and Proposed Facilities, Phoenix Indian Medical Center. Page #1





Note: Contractor to provide extra set of monitors on roll around pedestals. Contractor also to provide pedestal and manual cradle head for alternate mounting of camera.

Figure D.17. Approximate Equipment Locations, Pt. Dixon Indian Medical Center, First Floor.

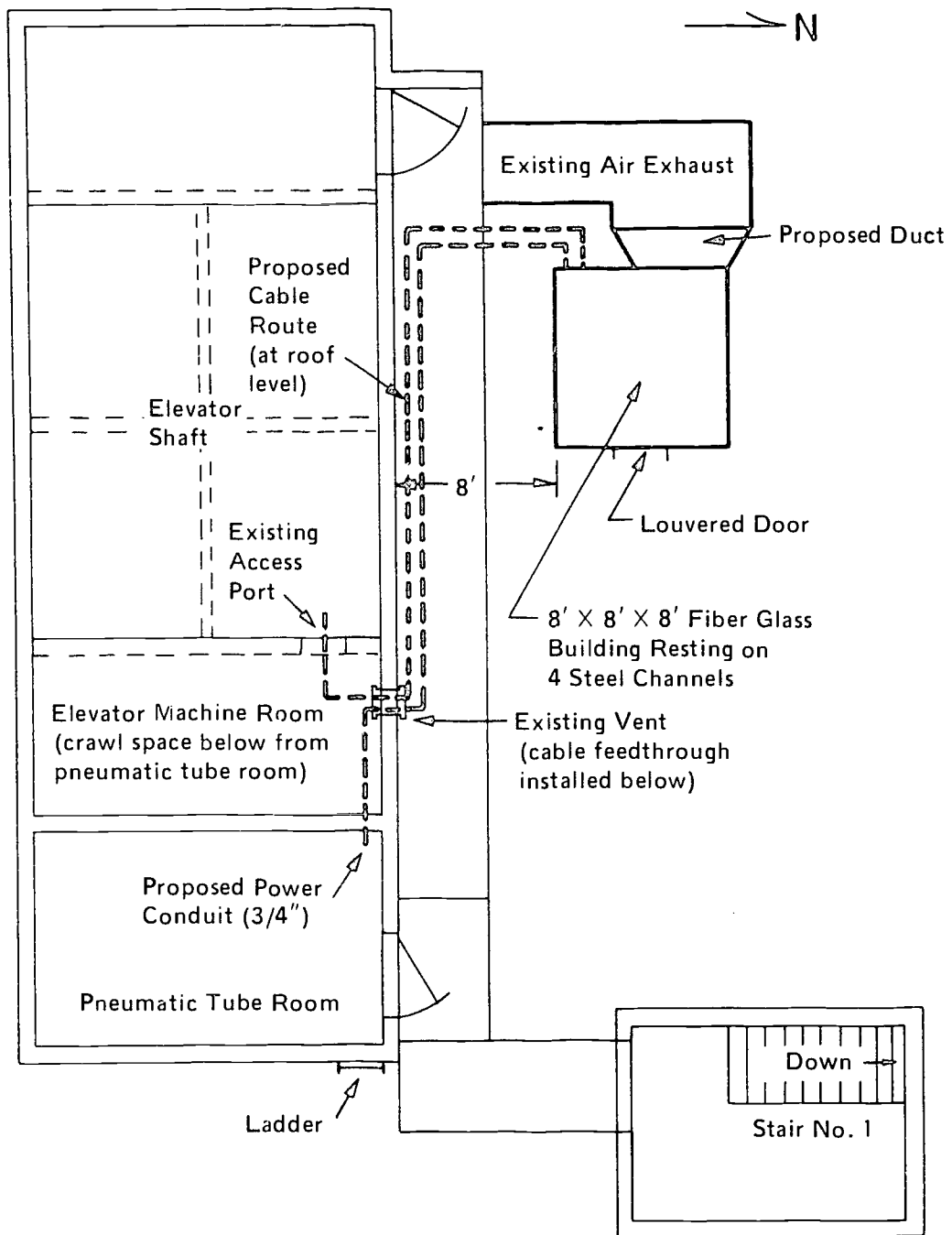

Notes:

1. Hospital to supply emergency and main power within the pneumatic tube room.
2. Cable vertical run in shaft to be secured to existing conduit.
3. Cable run consists of six coaxial cables.
4. Fiber glass prefab building to rest on four 4" X 6" X 1/4" steel channels:  $\square 4'' \begin{matrix} 6'' \\ \end{matrix}$ .
5. Existing exhaust air duct to be diverted through proposed equipment building.
6. Microwave dishes on 10' stub tower on roof above elevator machine room.

Figure D.18. Proposed Radio Facilities, Roof and Penthouse, Phoenix Indian Medical Center.

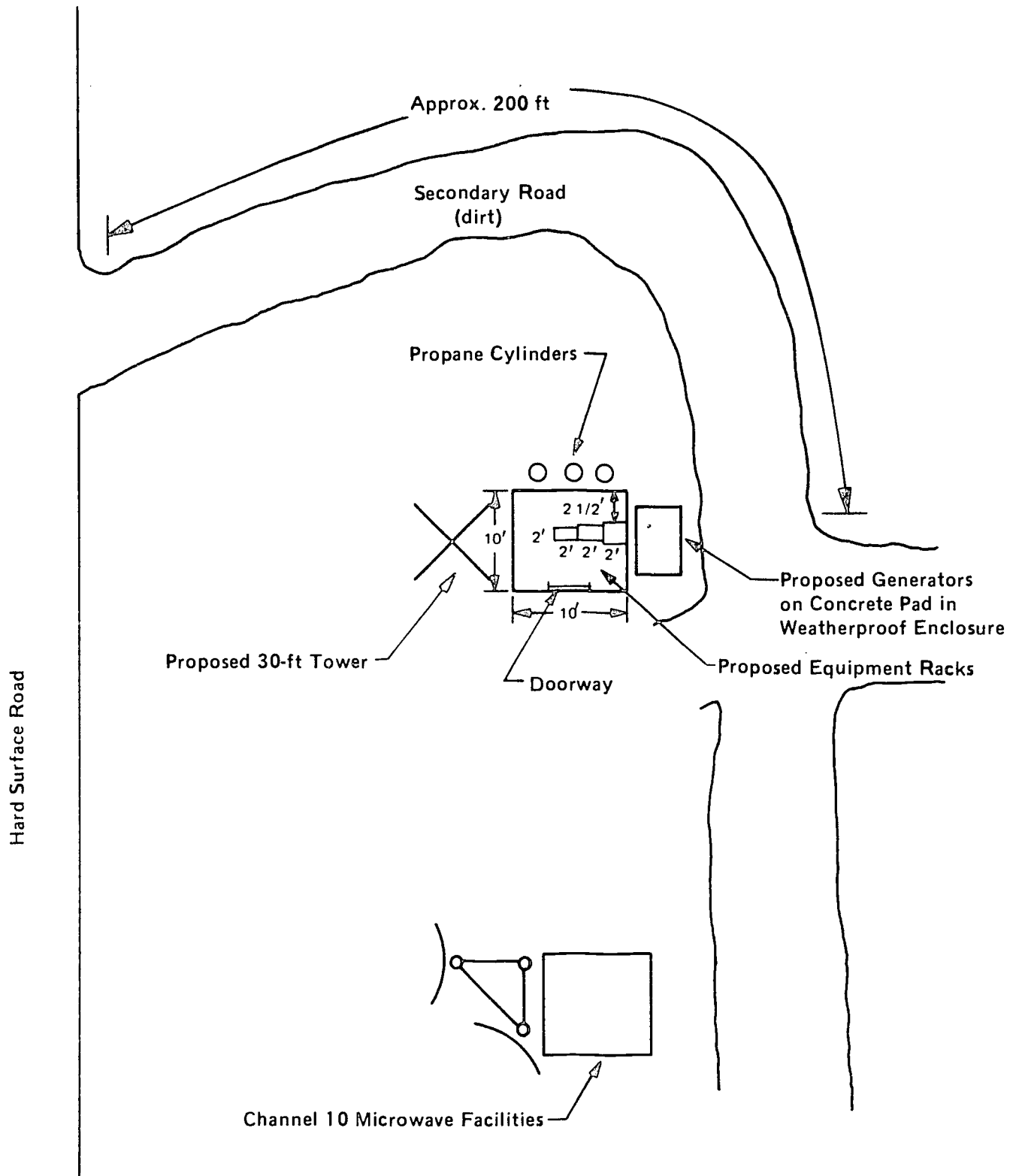

Note: Existing tower and generator must be removed. New tower will be located as shown. Existing VHF antennas shall be relocated thereon.

Figure D.19. Existing and Proposed Facilities, Pinal Peak.

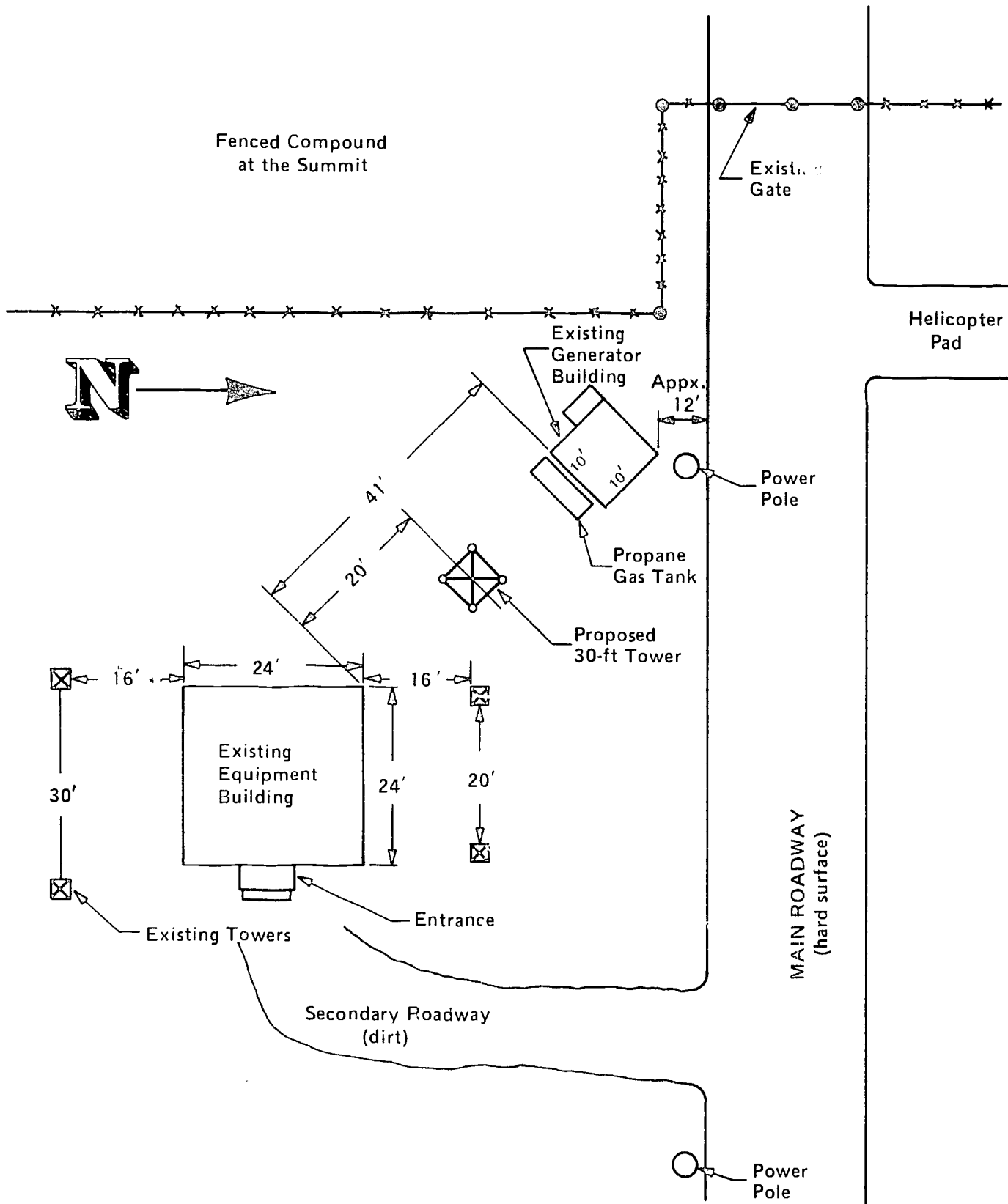

Figure D.20. Existing and Proposed Facilities, Mt. Lemmon.

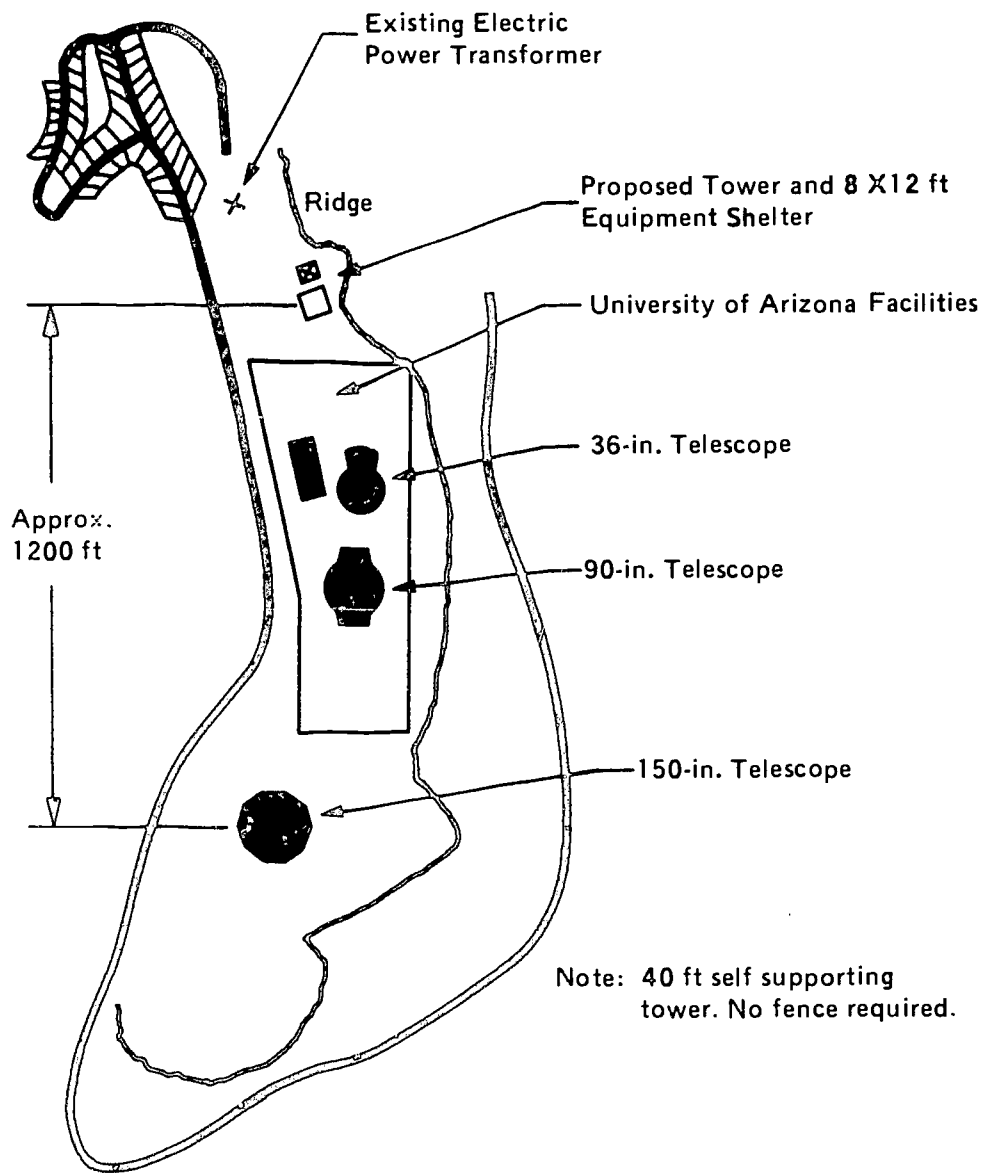

Figure D.21. Proposed Communication Facilities, Kitt Peak.

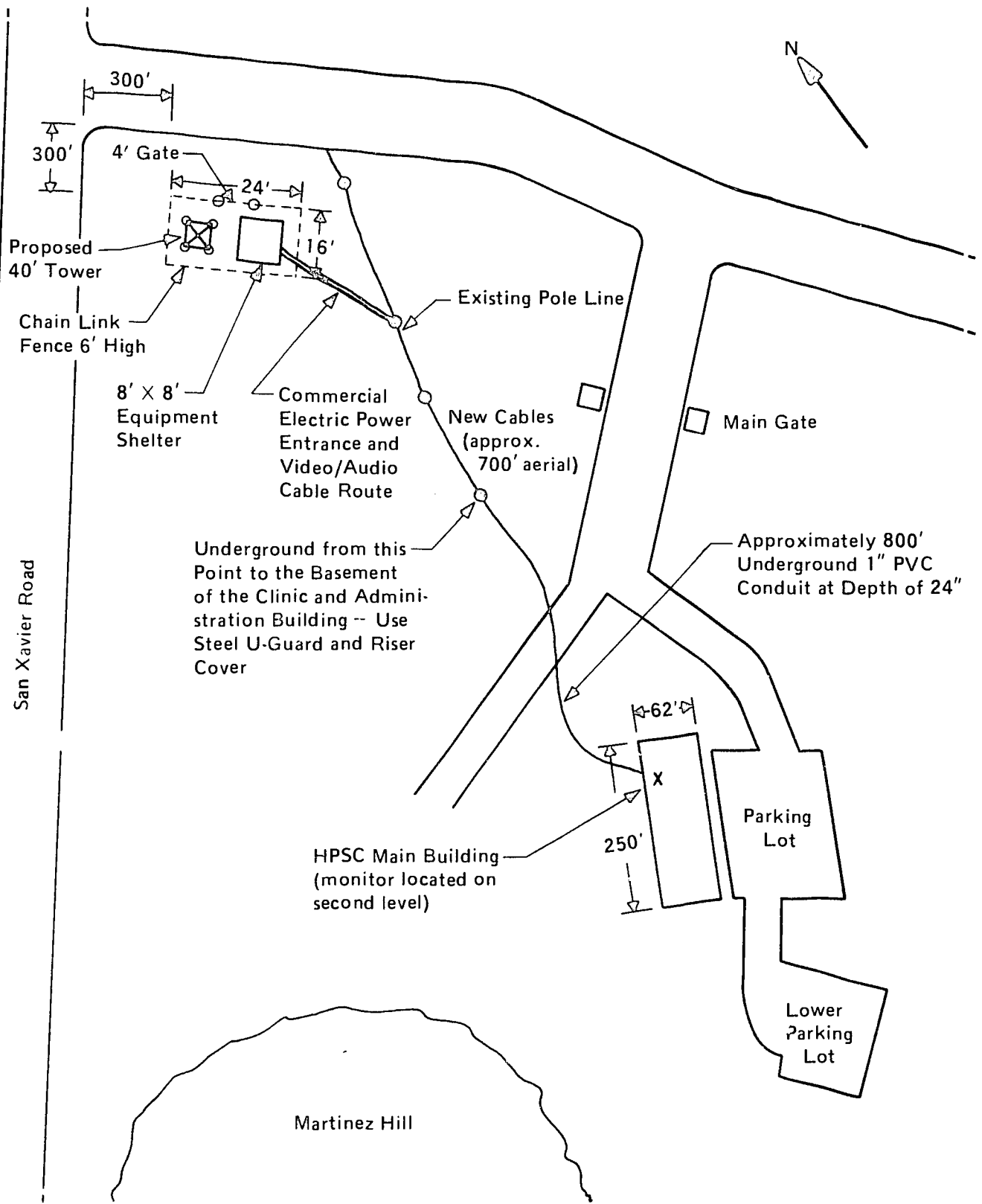
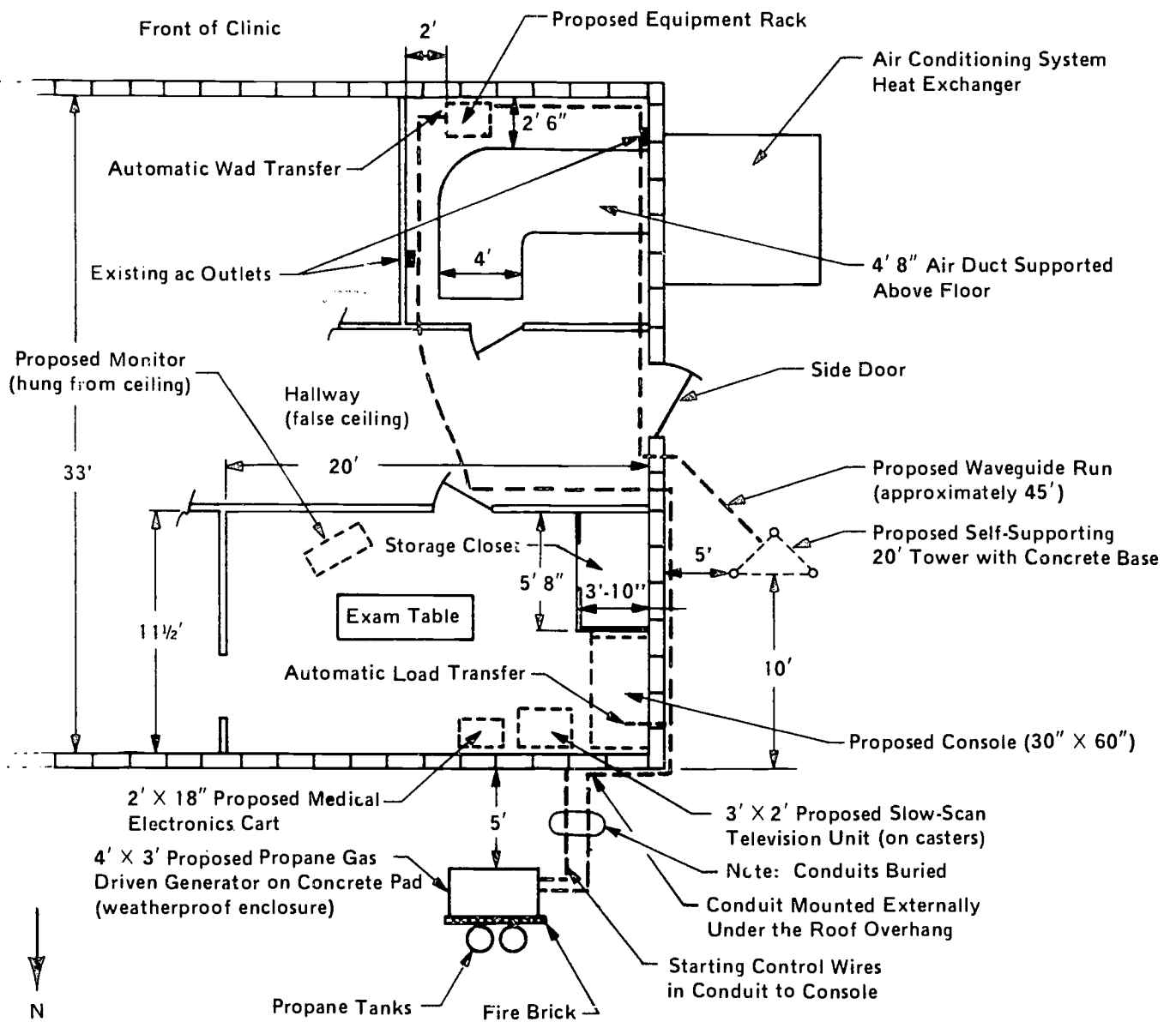

Figure D.22. Proposed Communications Facilities, San Xavier.





Note: Existing Wood Cabinets are to be Removed in Order to Make Room for the Proposed Console.

Figure D.23. Proposed Floor Plan and Equipment Arrangement, Santa Rosa Clinic.





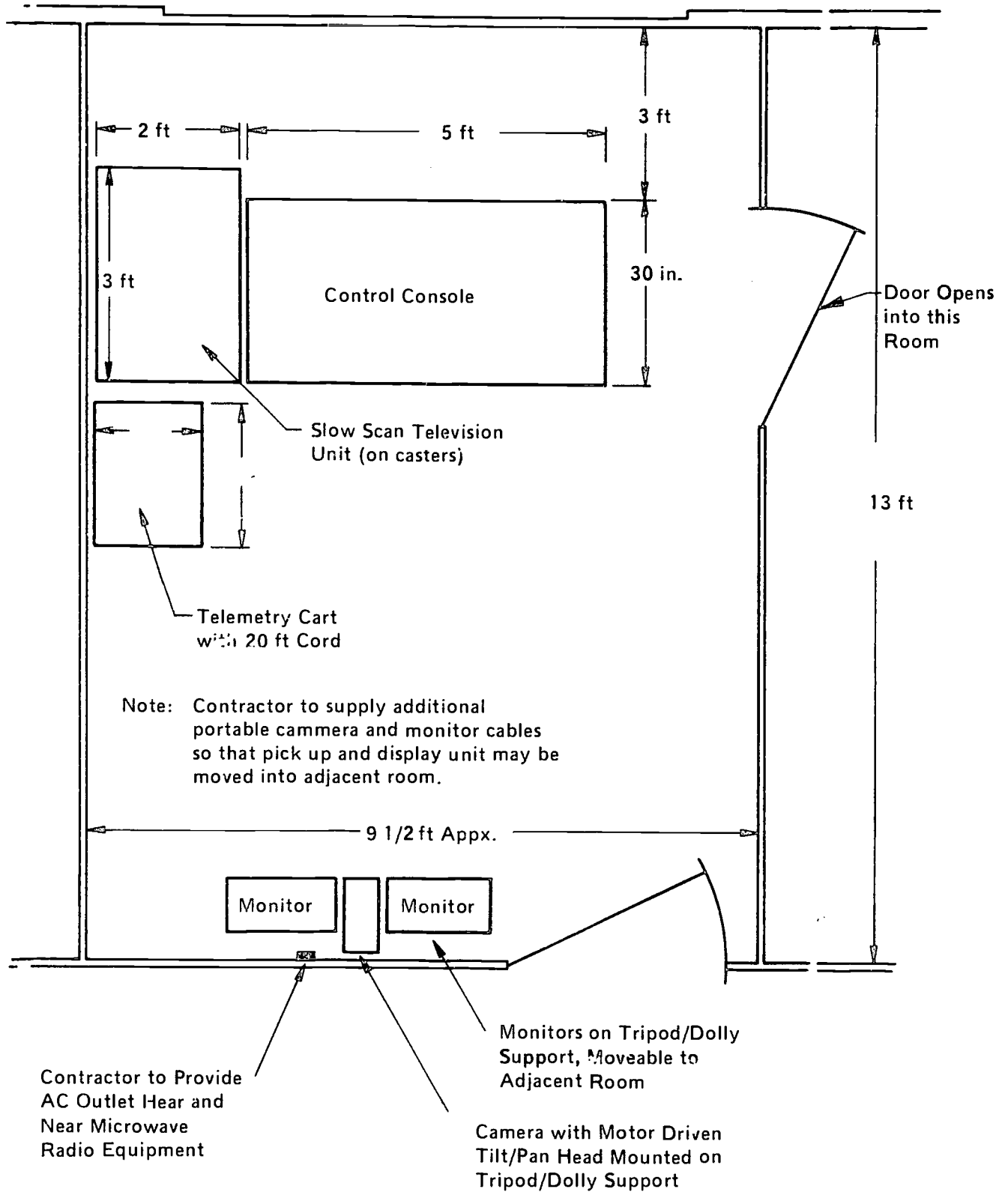

Figure D.25. Equipment Positions, Sells Hospital.



	San Xavier (loop back)	Sells	Pisinimo	Santa Rosa	To San Xavier (Receive)
From San Xavier (Transmit)	(RESET)	Sells	Pisinimo	Santa Rosa	

Note: Identical control panels will be provided for the other communication services.

Figure D.27. The Kitt Peak Video Switching Control Panel Located at Phoenix.  
(Shown approximately full size).

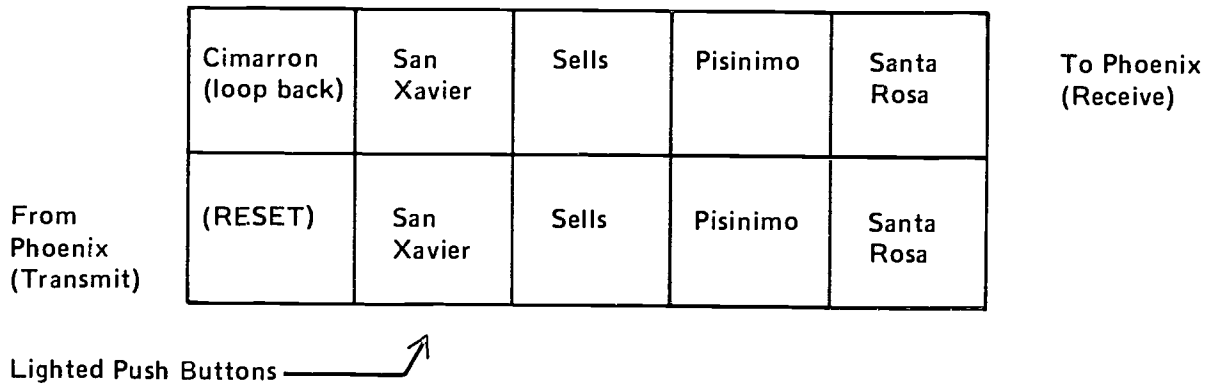

(Receive buttons are interlocked - only one at a time may be activated).

(Transmit buttons are independent except for the reset button which de-activates the other indicator lamps and resets all switches so marked on the matrix drawing).

Note: Identical panels will be provided for telemetry and slow-scan TV.

Figure D.28. The Kitt Peak Video Switching Control Panel Located at the University of Arizona Medical Center, Tucson.  
(Shown approximately full size).

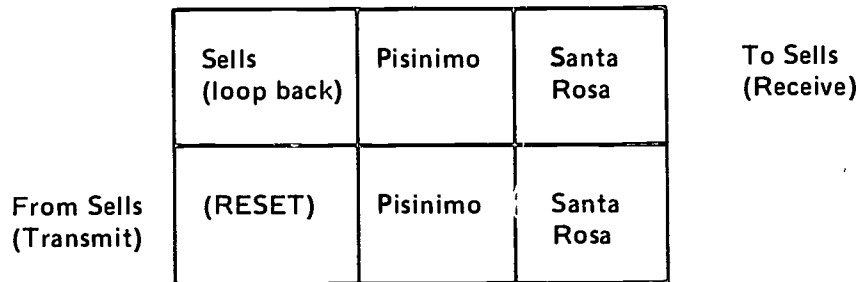

**Note:** Identical control panels will be provided for the other communication services, as well.

**Figure D.29.** The Kitt Peak Video Switching Panel Located at Sells.  
(Shown approximately full size).



	To Tucson	To Mt. Lemmon/Pinal Peak	To Kitt Peak	
Tucson	Tucson	Tucson	Tucson	To Tucson
Tucson	Tucson	Tucson	Tucson	To Mt. Lemmon/Pinal Peak
Tucson	Tucson	Tucson	Tucson	To Kitt Peak

Figure D.30. San Xavier Switch Function Assignments.

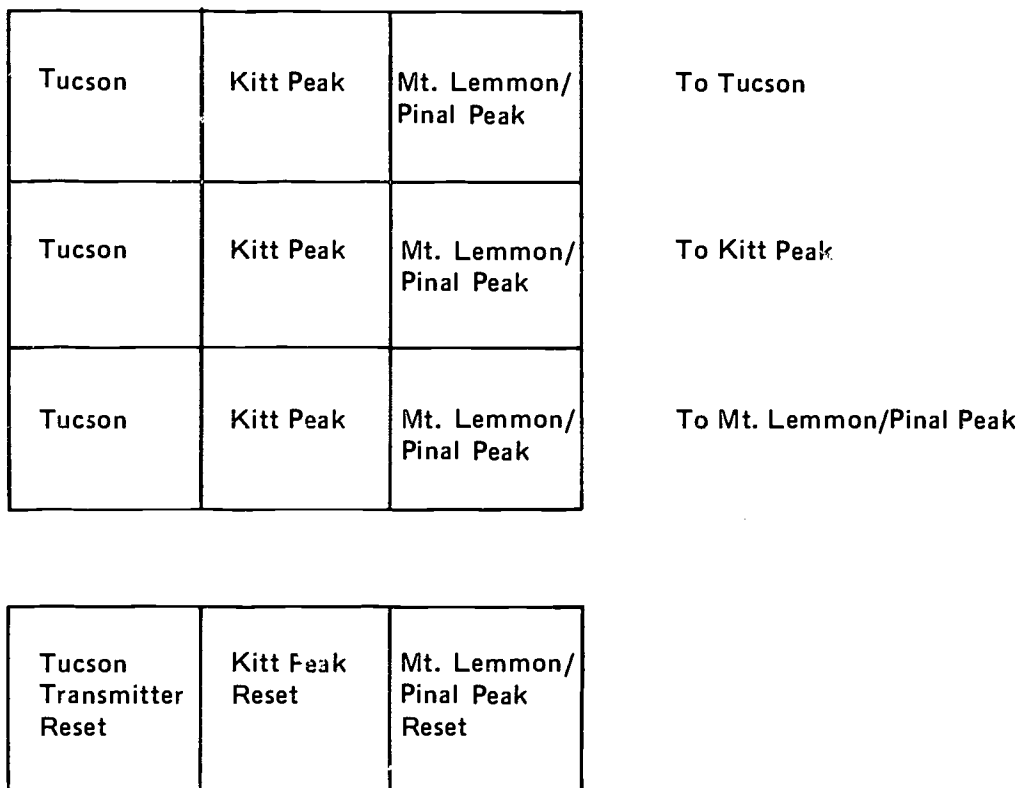

**Notes:**

Horizontal rows use interlocking push buttons. (Only one may be activated at a time.)

Identical panels will be provided for switching telemetry and slow-scan television.

**Figure D.31. The San Xavier Video Switching Control Panel  
Located at Arizona Medical Center, Tucson.**

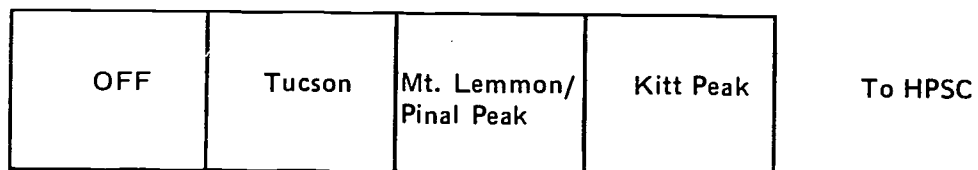
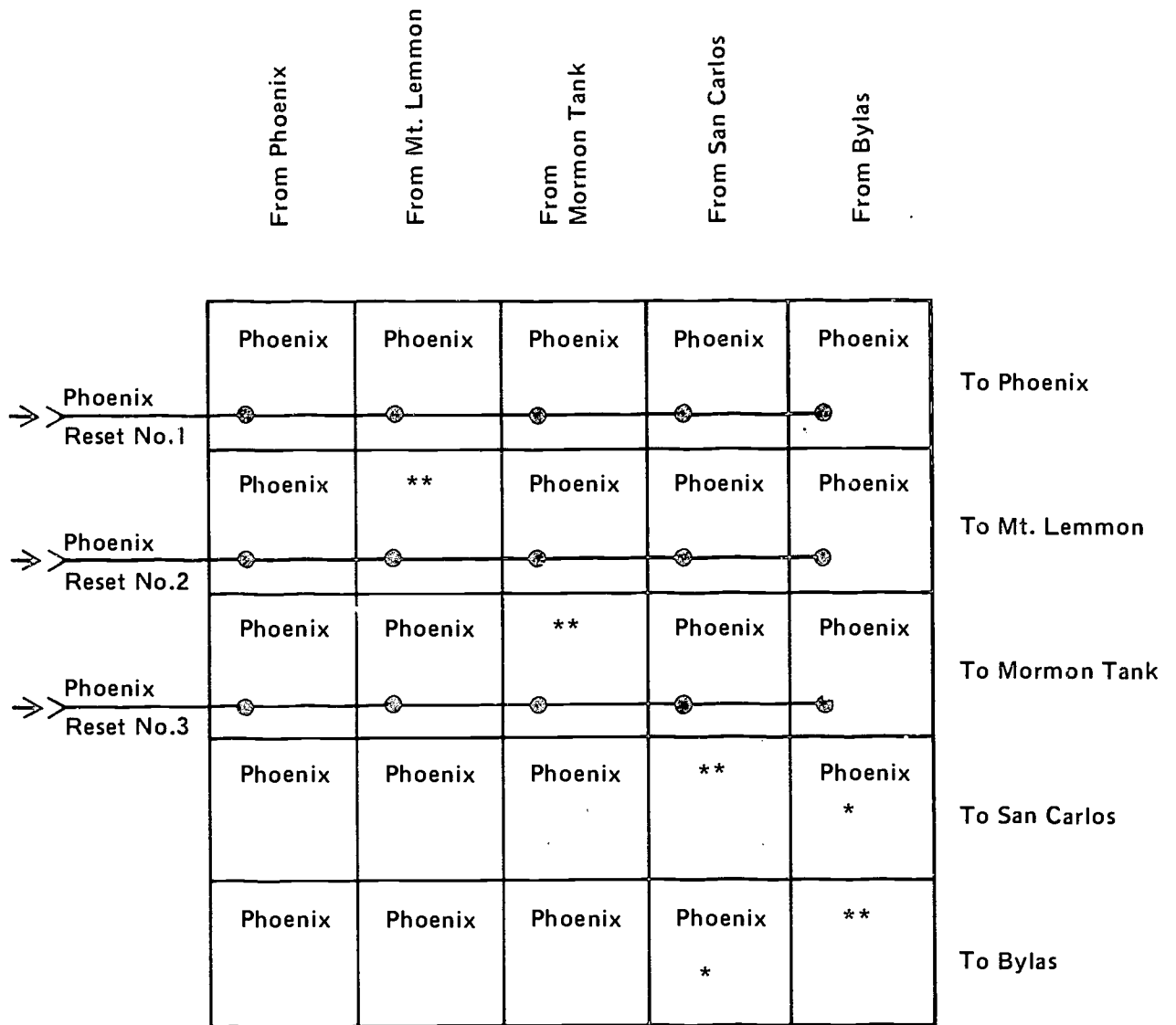

Figure D.32. HPSC Monitor Switch Control Panel Located at Arizona Medical Center, Tucson.



Note: Tucson may request monitor service through Phoenix to view signals from Mormon Tank, Bylas, San Carlos and elsewhere. Such service is subject to the availability of a circuit.

- \* Normally always activated, acts as "reset".
- \*\* Positions not used.

Figure D.33. Pinal Peak Switch, Function Assignments.

RESET	Phoenix	Mt. Lemmon	Mormon Tank Relay	San Carlos	Bylas	To Phoenix
RESET	Phoenix	(Blank)	Mormon Tank Relay	San Carlos	Bylas	To Mt. Lemmon
RESET	Phoenix	Mt. Lemmon	(Blank)	San Carlos	Bylas	To Mormon Tank Relay
	Phoenix	Mt. Lemmon	Mormon Tank Relay	(Blank)	Bylas	To San Carlos
	Phoenix	Mt. Lemmon	Mormon Tank Relay	San Carlos	(Blank)	To Bylas

Figure D.34. The Pinal Peak Video Switching Control Panel Located at Phoenix.  
(Shown approximately full size)

### Local Matrix

RESET	PHOENIX	SOUTH MTN	PINAL PEAK	TO PHOENIX CONTROL
RESET	PHOENIX	SOUTH MTN	PINAL PEAK	TO PINAL PEAK
RESET	PHOENIX	SOUTH MTN	PINAL PEAK	TO SOUTH MTN

Figure D.35. Local Control Panel and Matrix at Phoenix  
(for Switching at Phoenix).

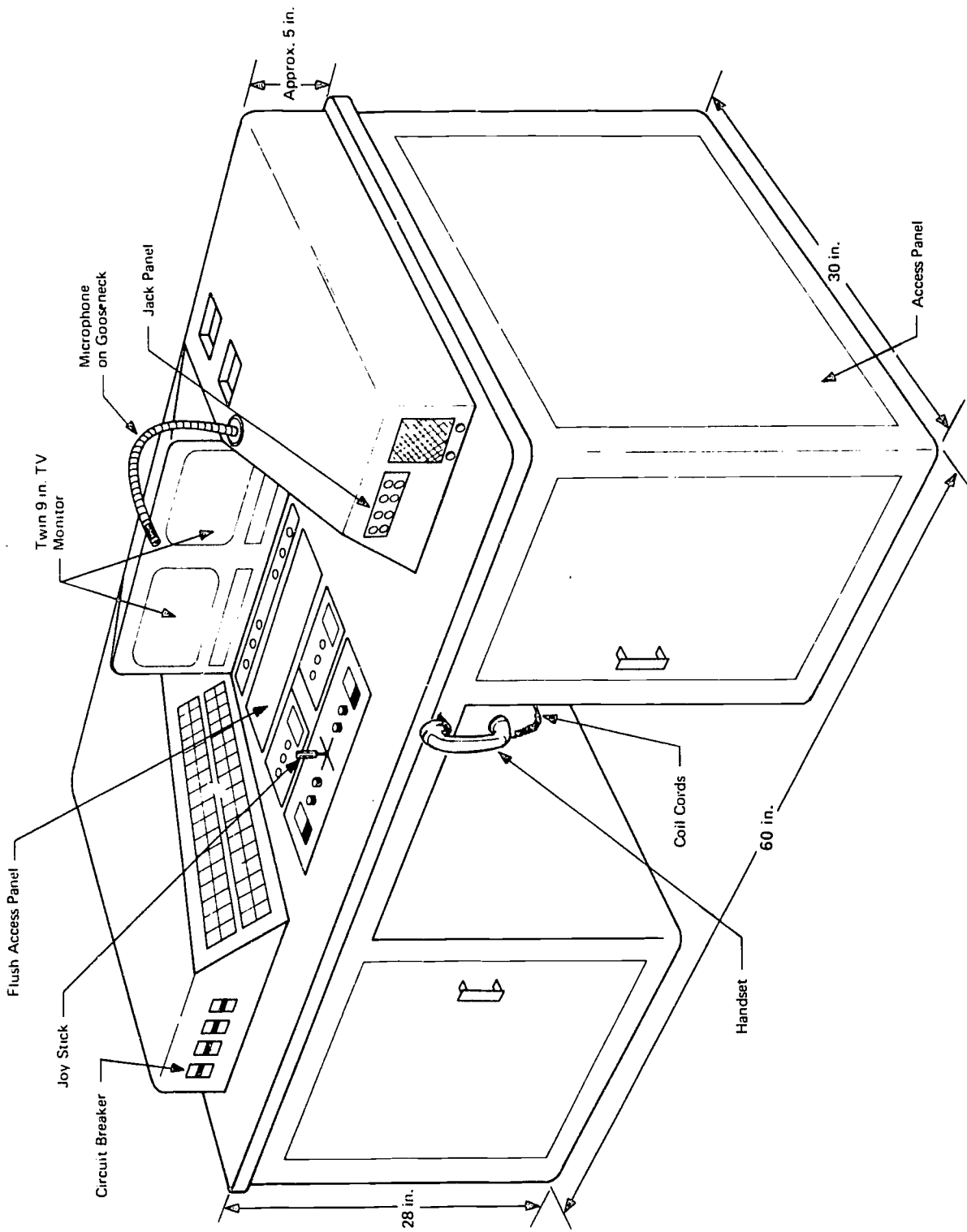

Figure D.36. Typical Control Console.

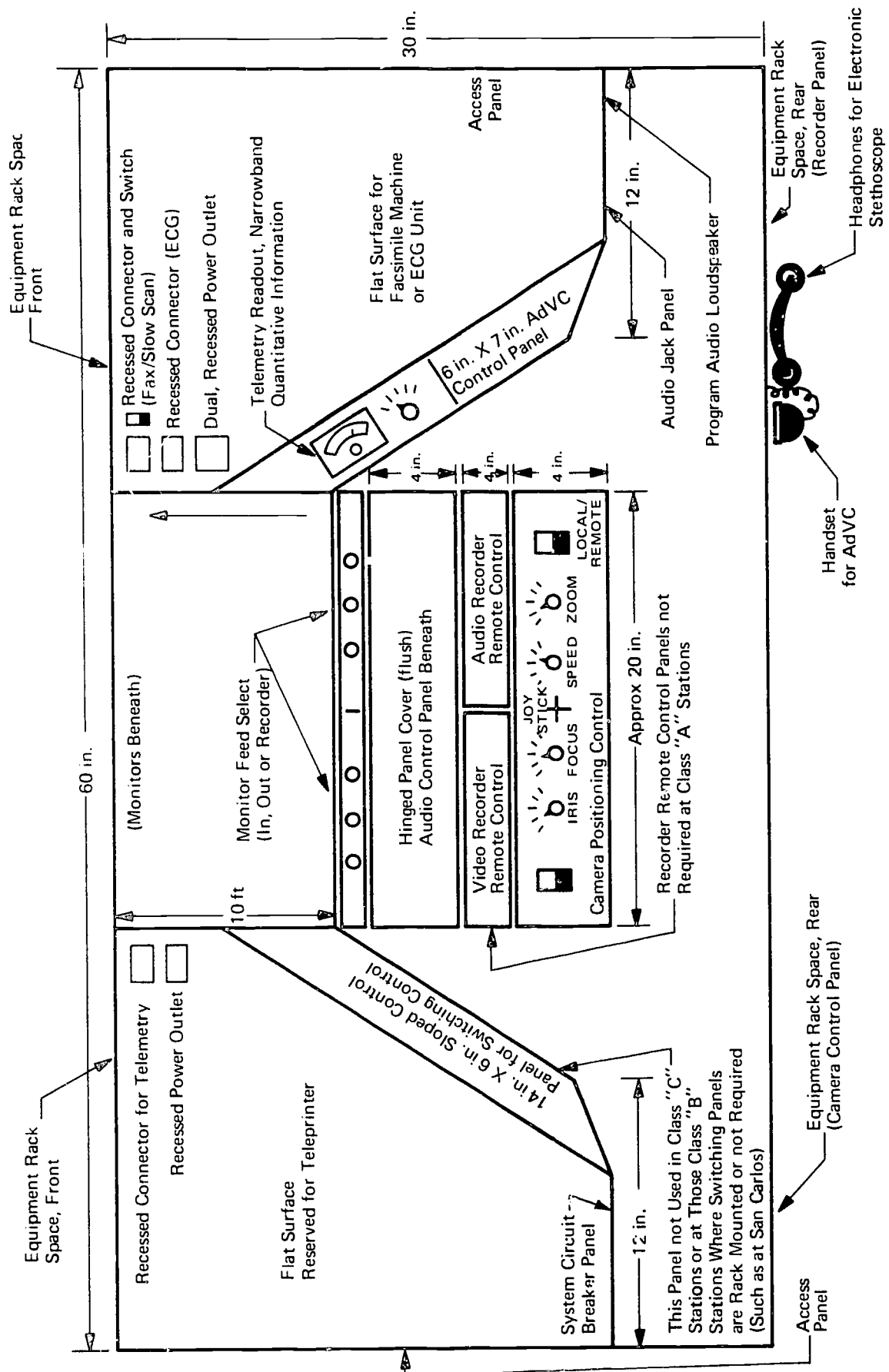

Figure D.37. Console, Top View.



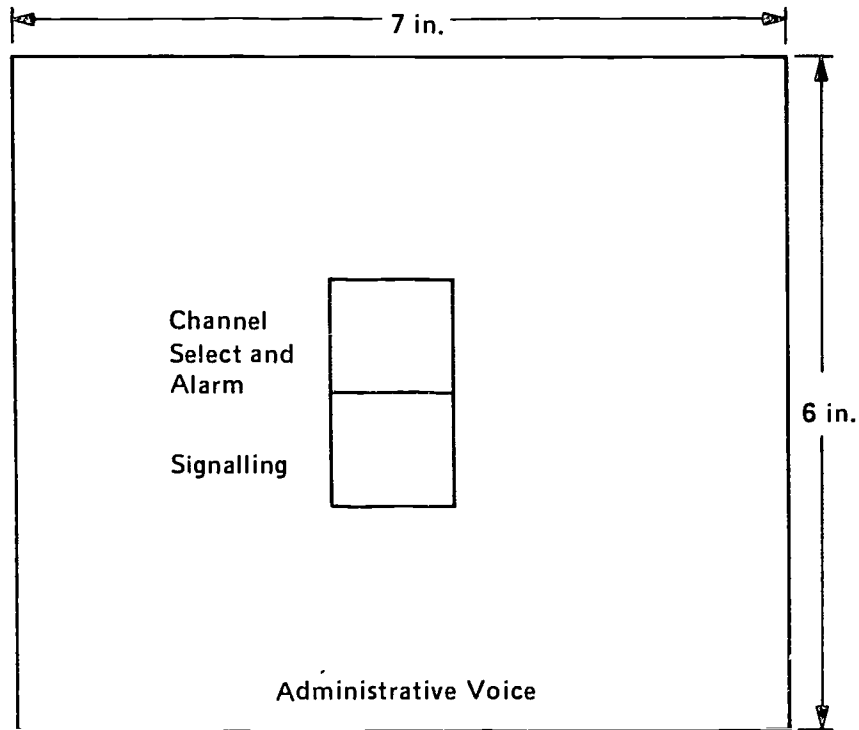

Figure D.38. AdVC Panel Layout, all Class "a" Stations (Bylas, Pisinimo, Santa Rosa).

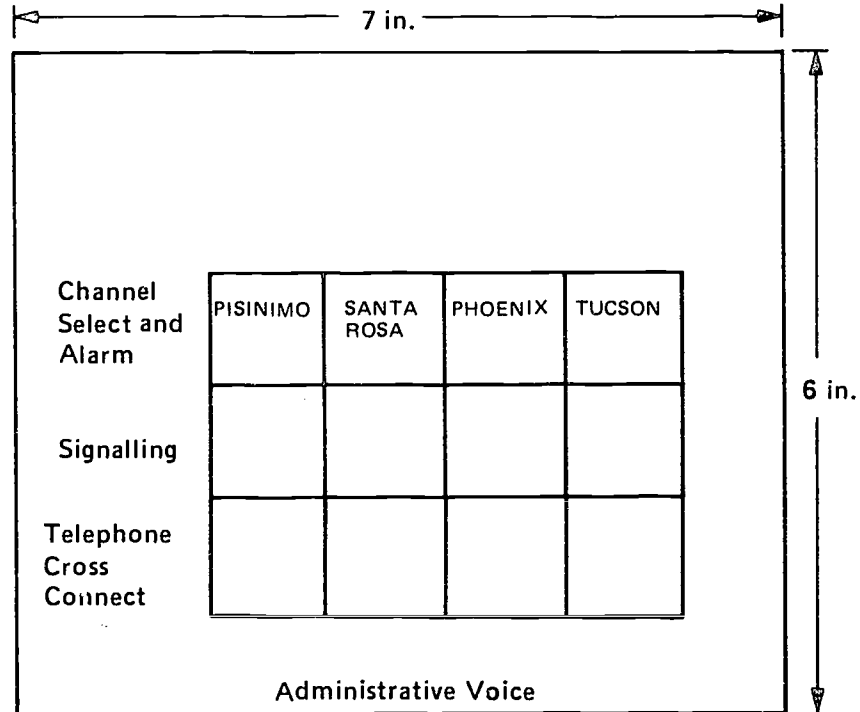

Figure D.39. AdVC Panel, Sells Hospital.

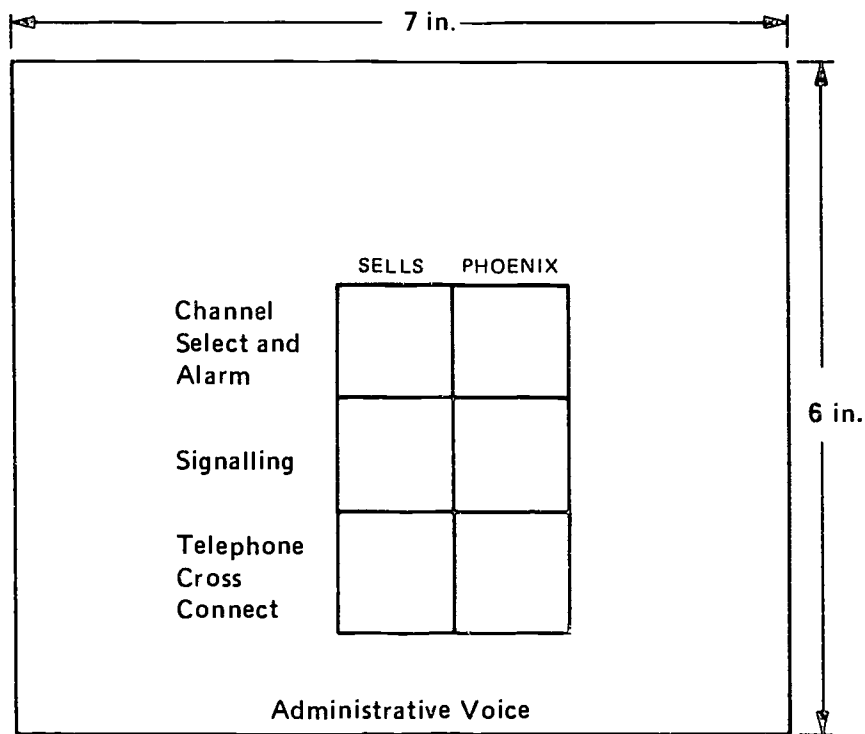

Figure D.40. AdVC Panel, University of Arizona Medical Center (Tucson).

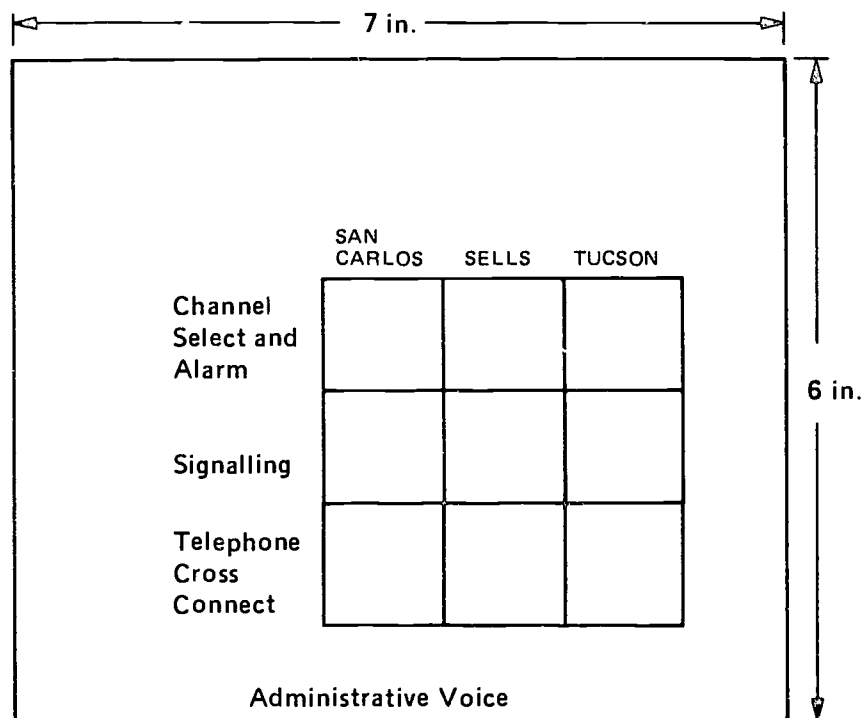

Figure D.41. AdVC Panel, Phoenix Medical Center.

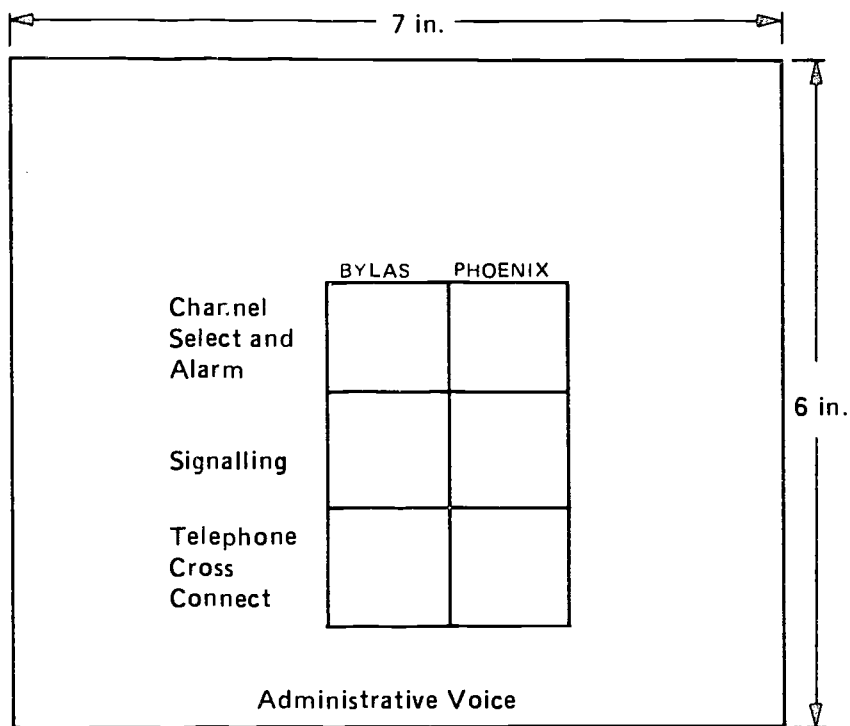

Figure D.42. AdVC Panel Layout, San Carlos.

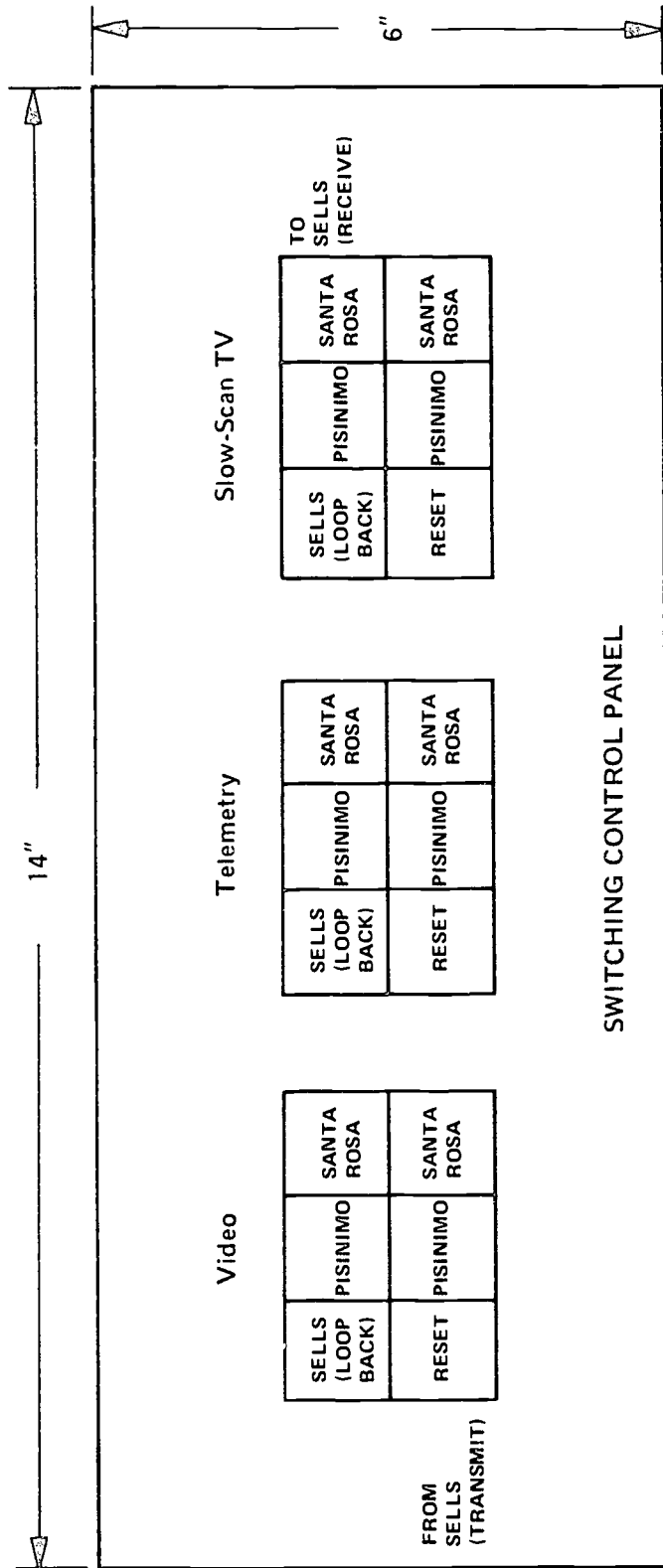
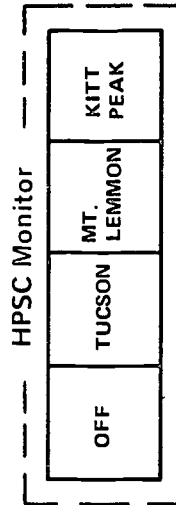
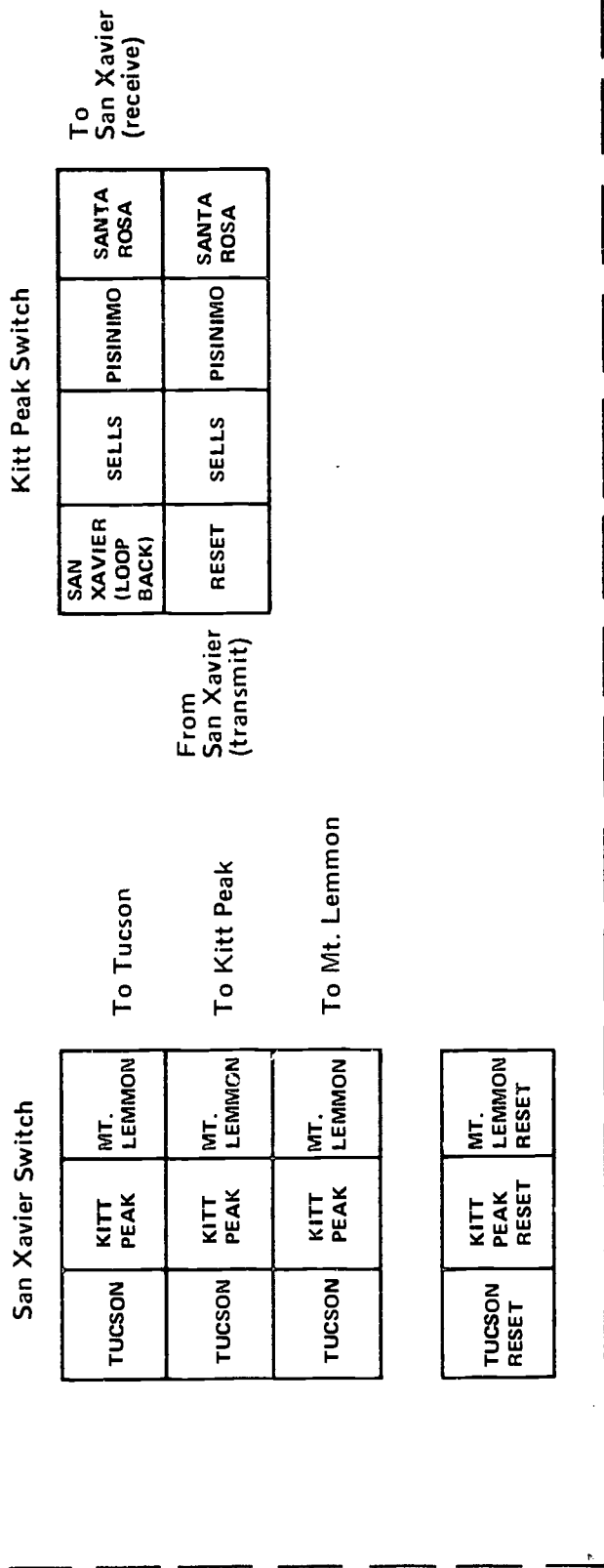

Figure D.43. Switching Control Panel Layout, Sells.



SLOW-SCAN TV SWITCHING CONTROL

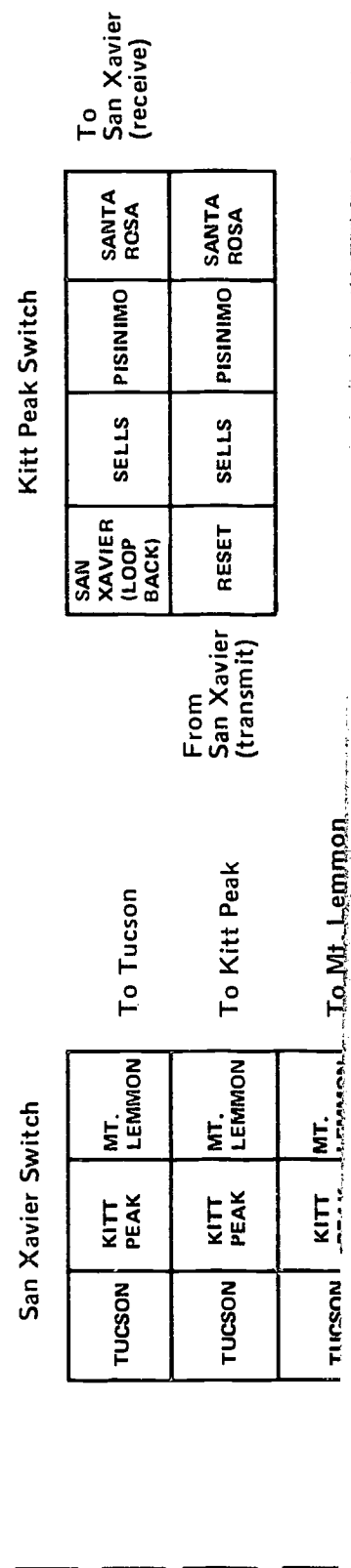

Figure D.44. Switching Control Panel Layout, Tucson  
 Page #1 213

TUCSON RESET	KITT PEAK RESET	MT. LEMMON RESET
-----------------	-----------------------	------------------------

TELEMETRY SWITCHING CONTROL

San Xavier Switch

TUCSON	KITT PEAK	MT. LEMMON
TUCSON	KITT PEAK	MT. LEMMON
TUCSON	KITT PEAK	MT. LEMMON

To Tucson

From  
San Xavier  
(transmit)

To Kitt Peak

To Mt. Lemmon

Kitt Peak Switch

SAN XAVIER (LOOP BACK)	SELLS	PISINIMO	SANTA ROSA
RESET	SELLS	PISINIMO	SANTA ROSA

To  
San Xavier  
(receive)

Note: All push buttons to be rear illuminated type with designations as indicated above engraved thereon. Panel is to be finished in blue. Lettering and dashed lines painted in white. Panel is to be hinged at left to swing out for maintenance.

Figure D.44. Switching Control Panel Layout, Tucson.

Page # 2

VIDEO SWITCHING CONTROL

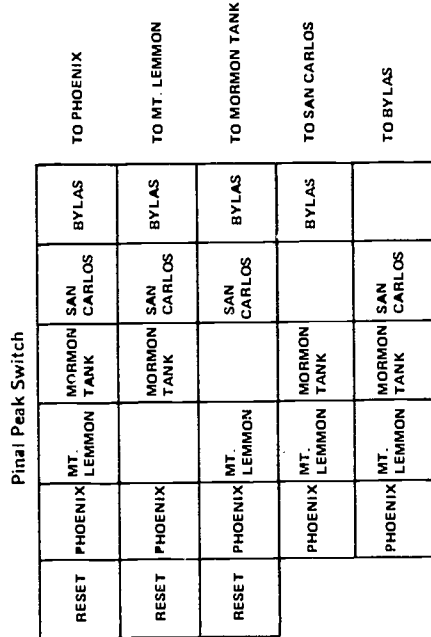
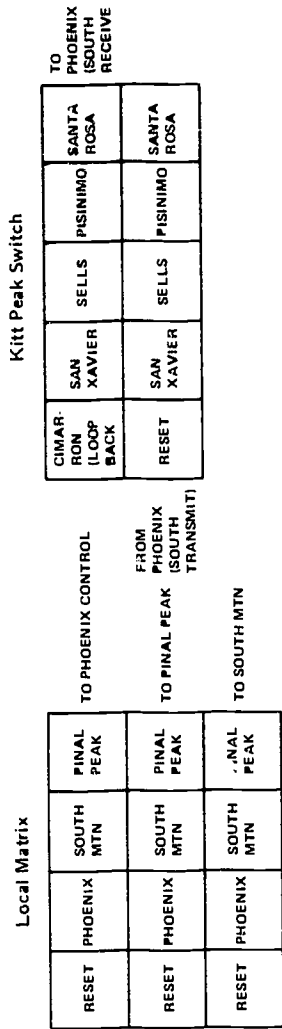

SLOW-SCAN TV SWITCHING CONTROL

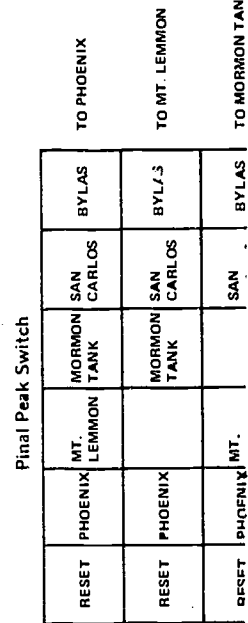
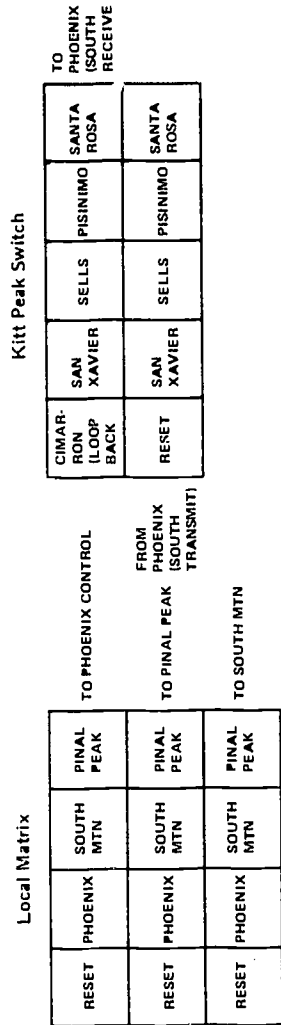

39"

Figure D. 45. Switching Control Panel Layout, Phoenix  
Page # 1.



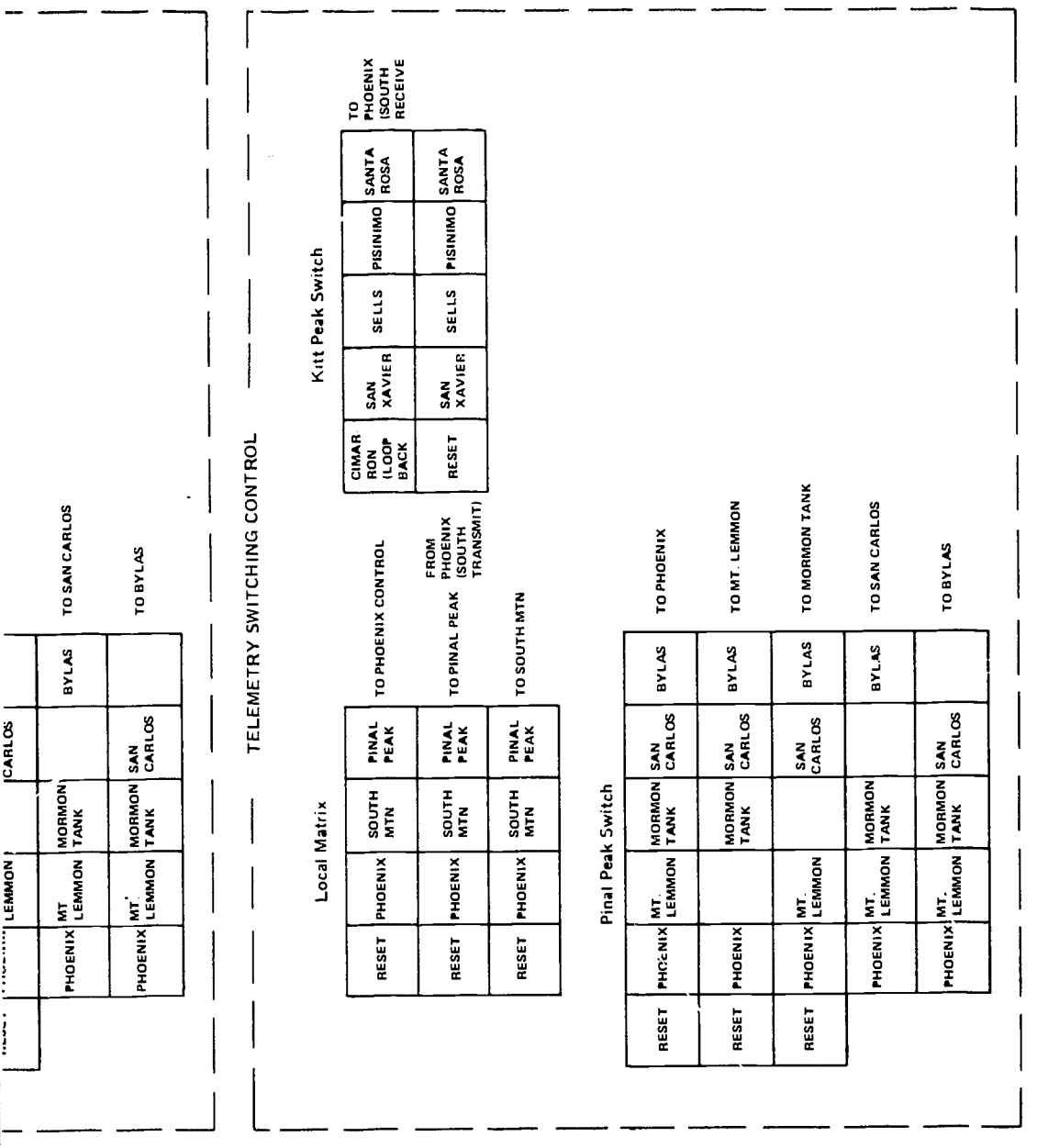

Note: All push button to be rear illuminated type with designations as indicated above engraved thereon. Panel is to be finished in blue. Lettering and dashed lines are to be painted in white. Panel to be hinged at left to swing out for maintenance.

Figure D.45. Switching Control Panel Layout, Phoenix.

Page #2.





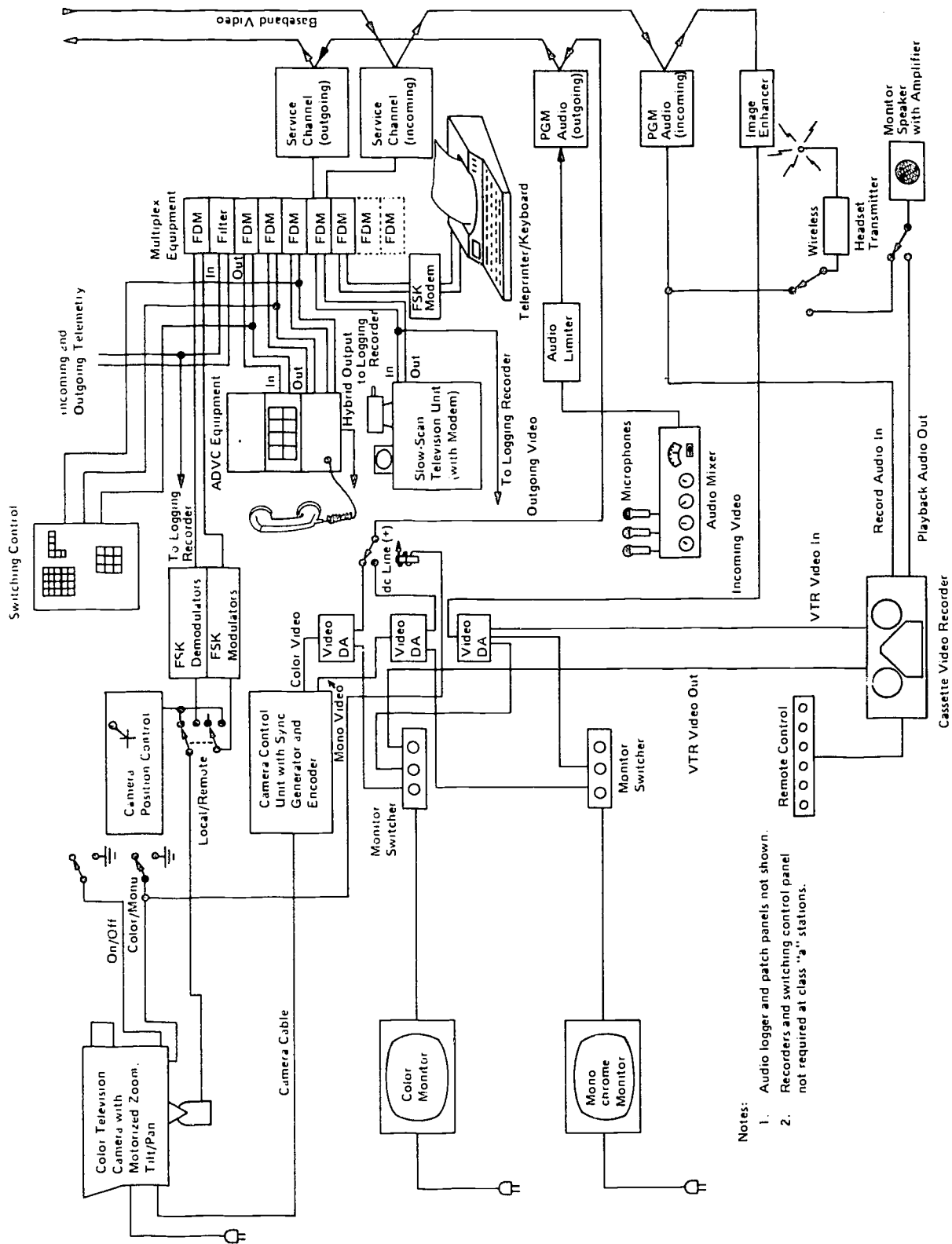

- Notes:
1. Audio logger and patch panels not shown.
  2. Recorders and switching control panel not required at class "b" stations.

Figure D.46. Functional Block Diagram, Typical Class "b" Station.

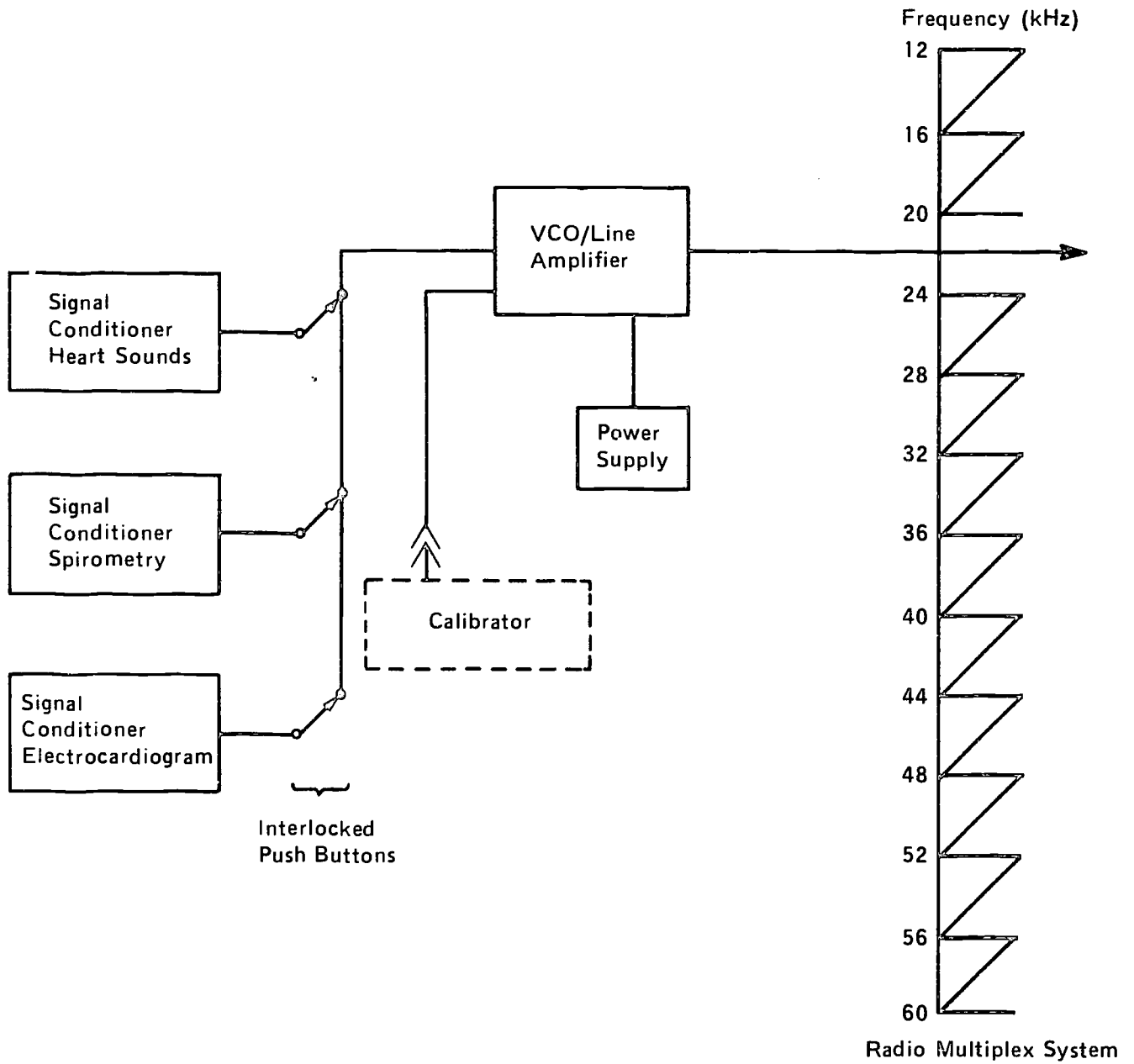

Figure D.47. Physiological Signals Transmission System.

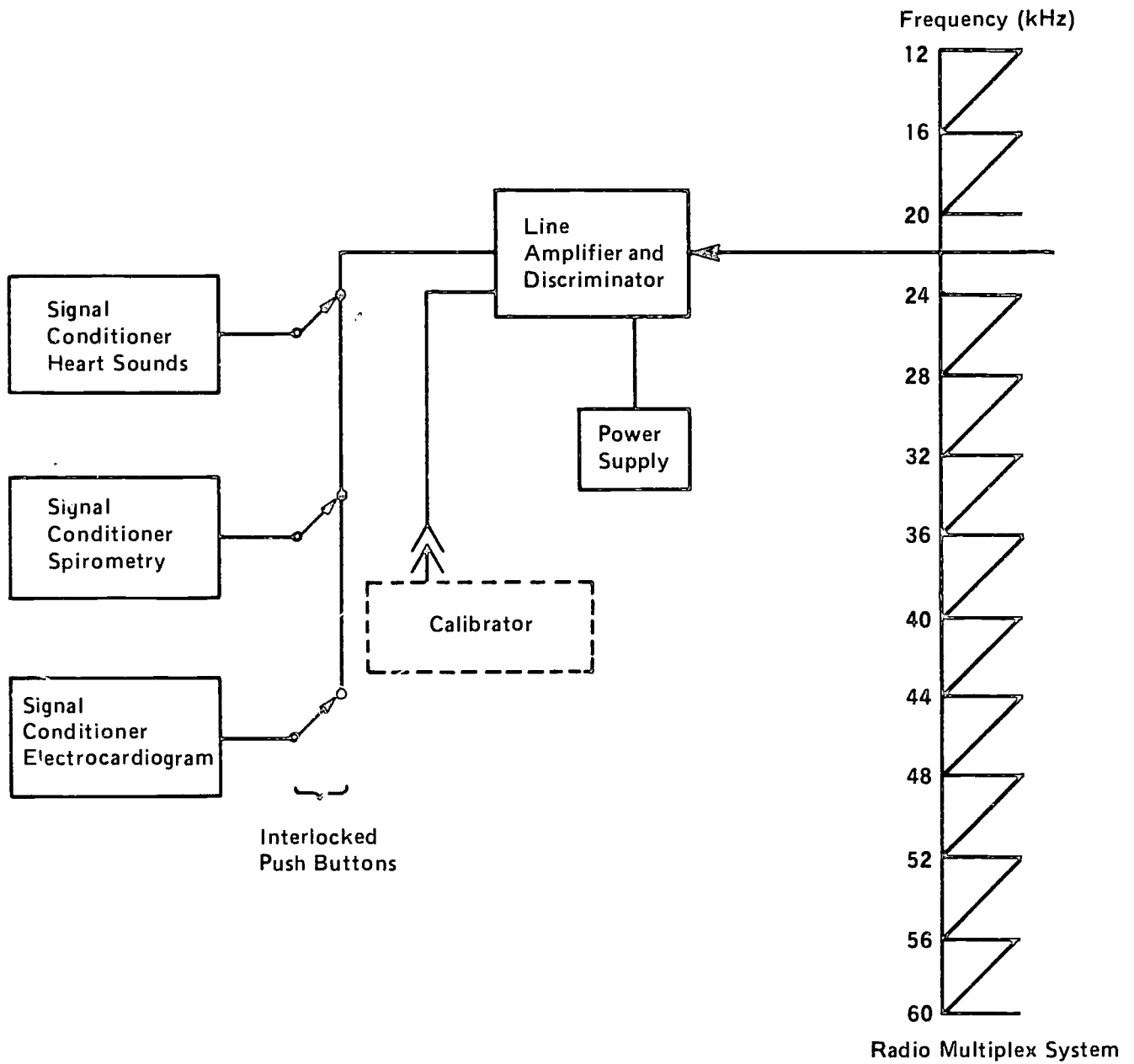

Figure D.48. Physiological Signals Receiving System.

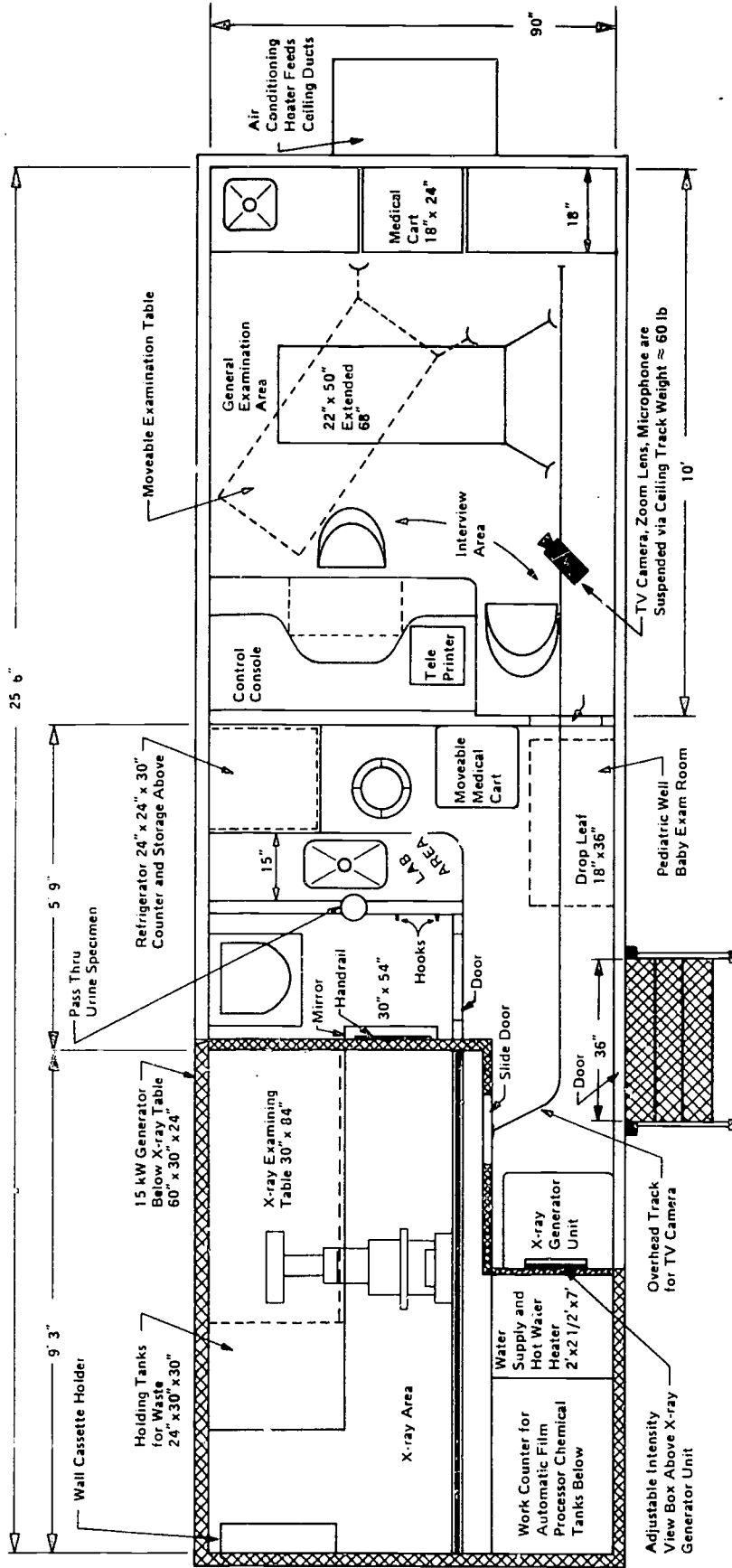
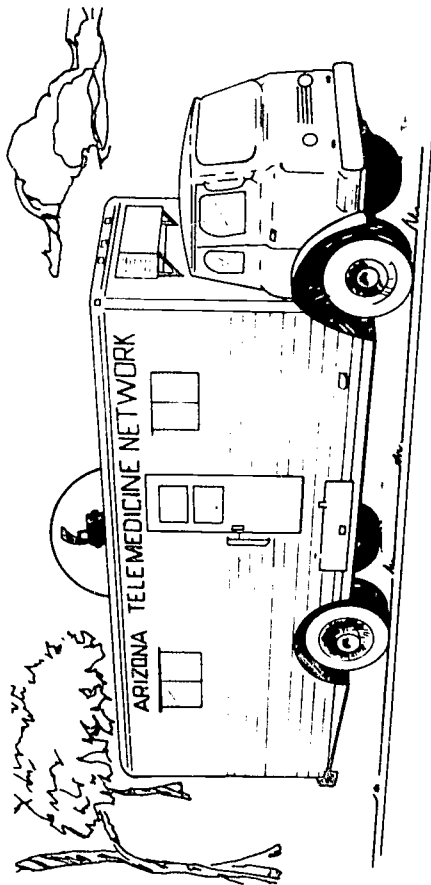
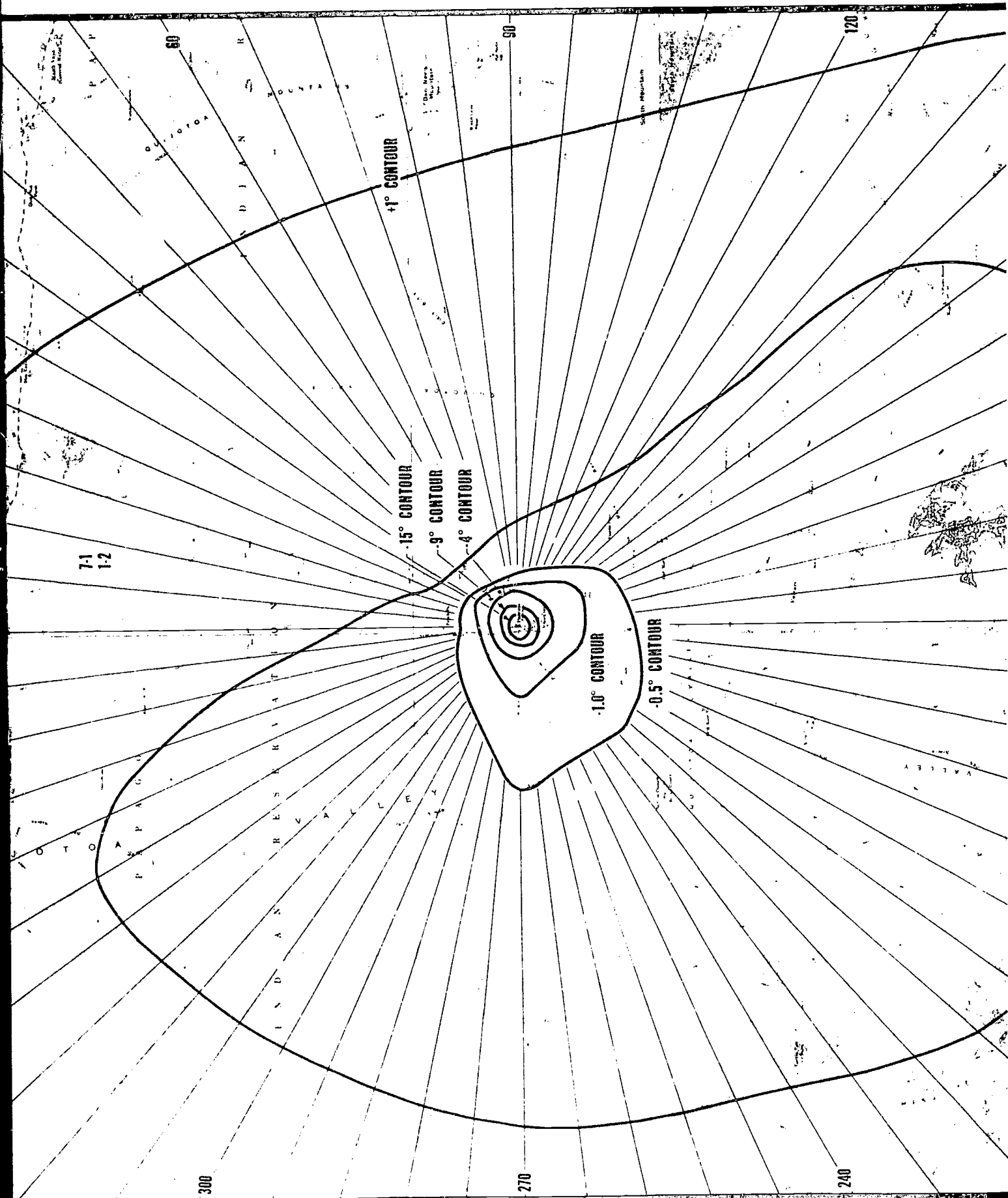

Figure D.49. Proposed Mobile Unit.



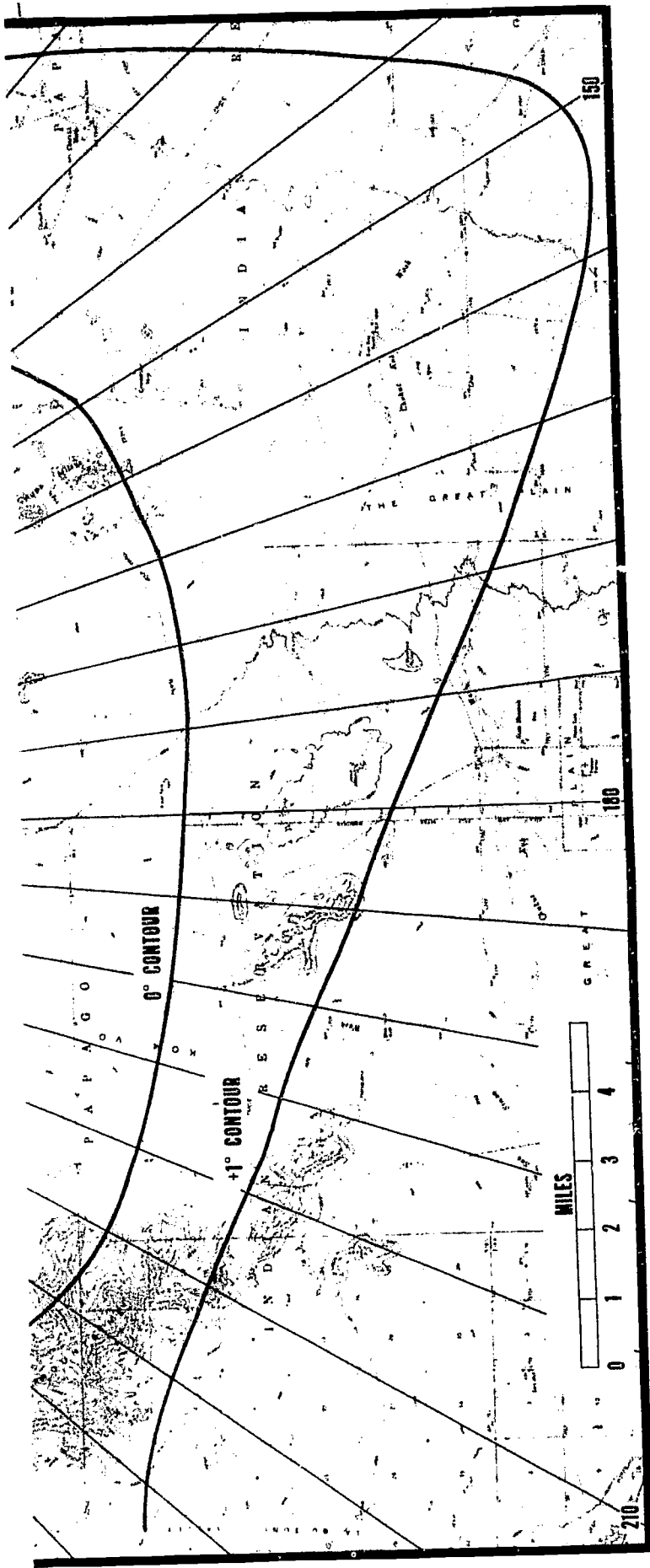

Figure D.50. Position Guide Overlay, Pisinimo Mobile Unit.

Page #2

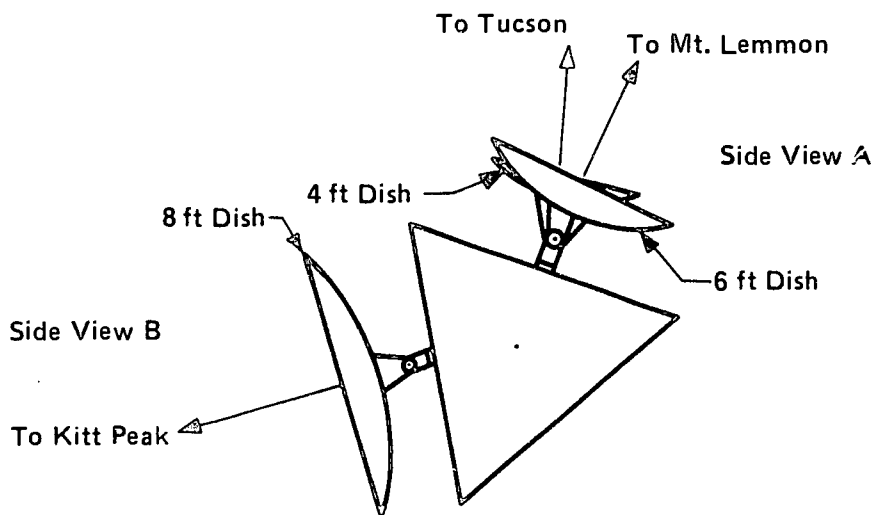
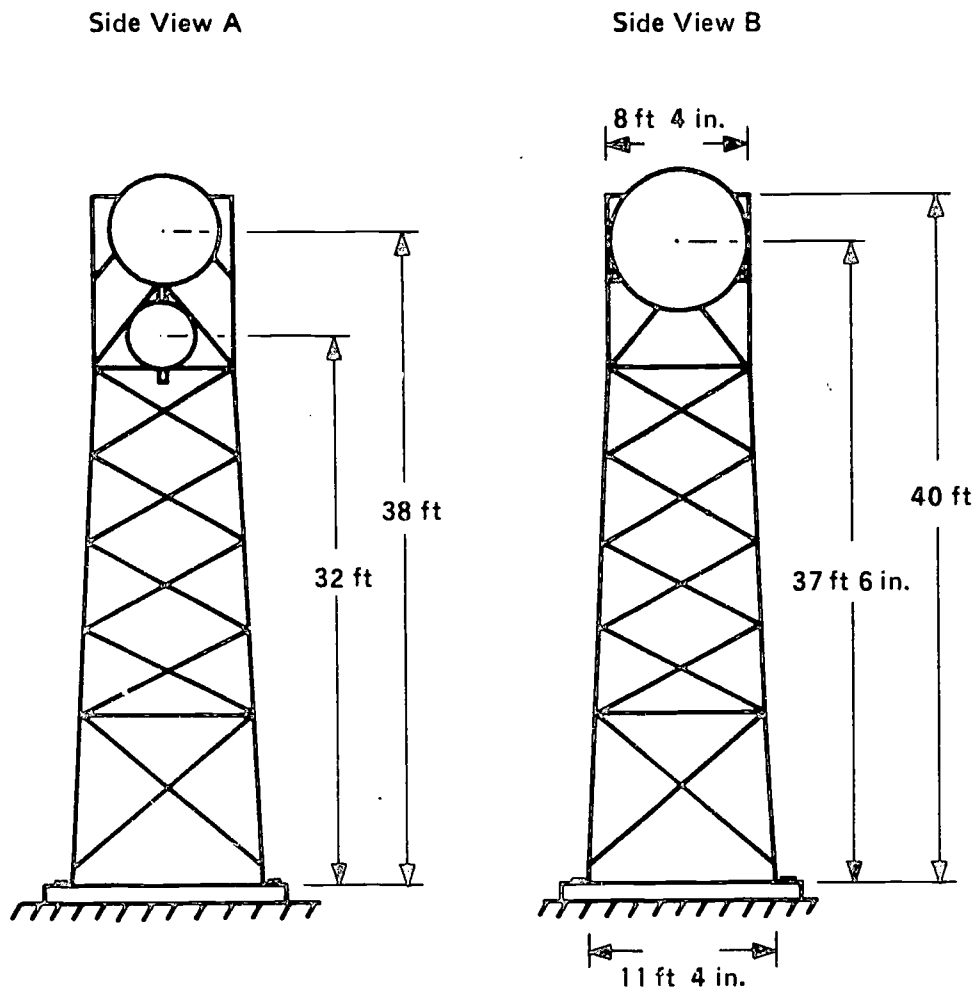

Figure D.51. New Tower and Antenna Arrangement at San Xavier.

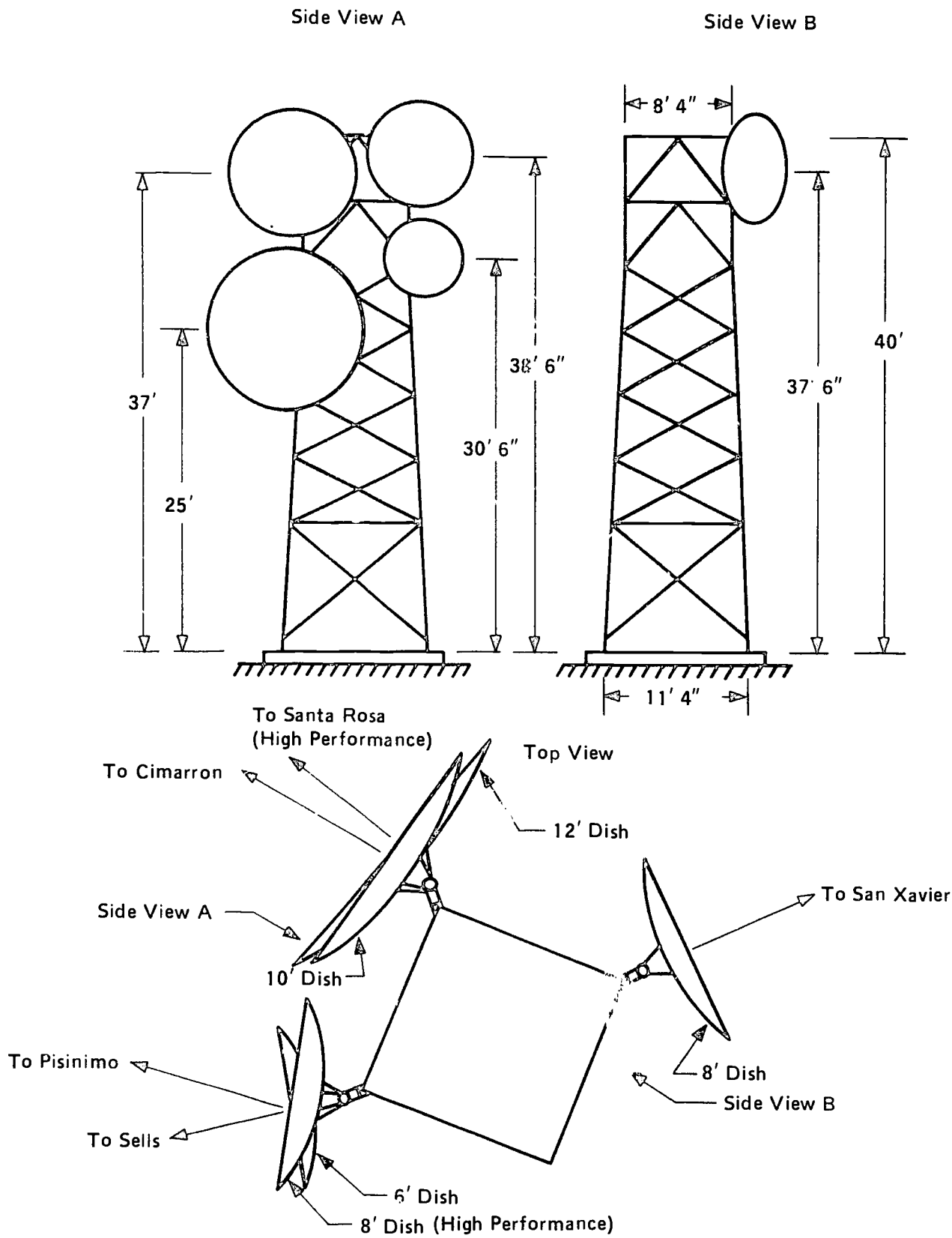
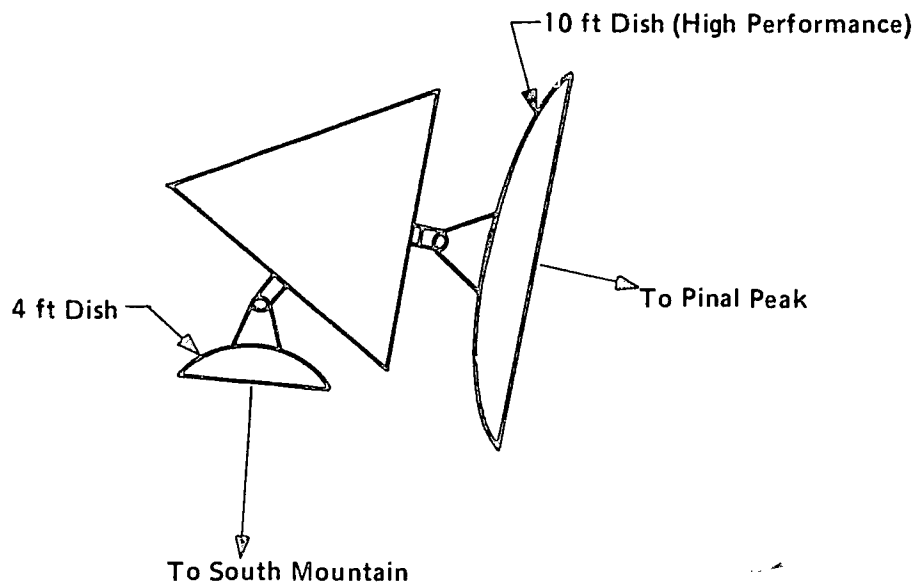
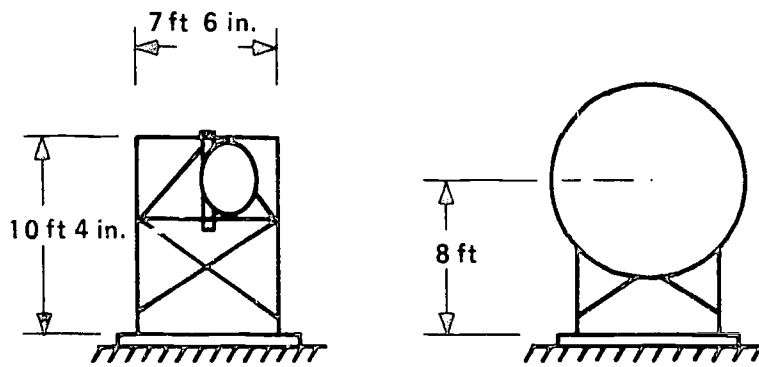

Figure D.52. New Tower and Antenna Arrangement at Kitt Peak.





**Special Note:** A high performance antenna is also required at South Mountain on the Cimarron Link.

Figure D.53. Support Structure and Antenna Arrangement at Phoenix.

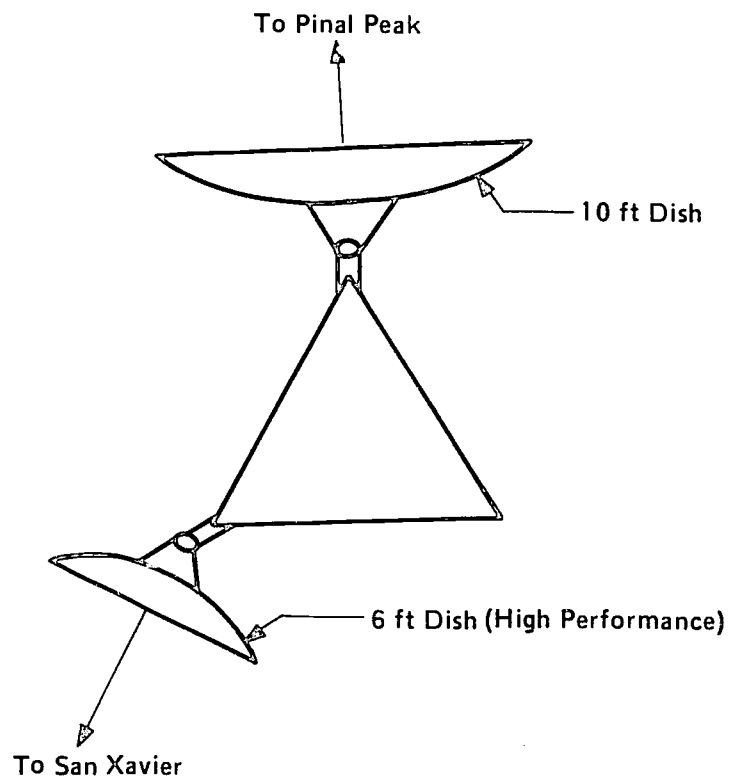
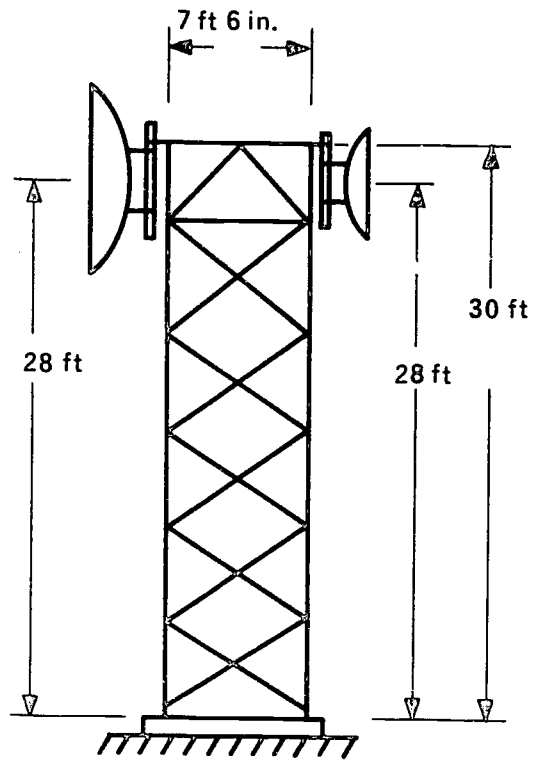
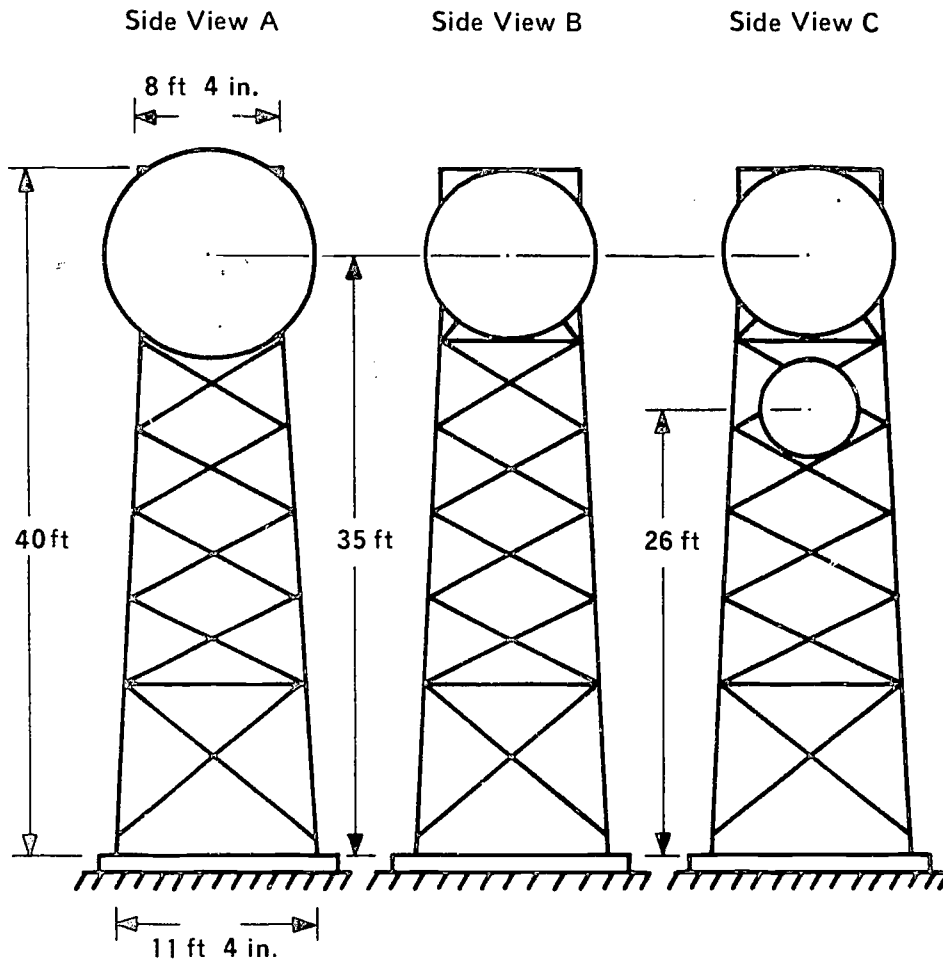
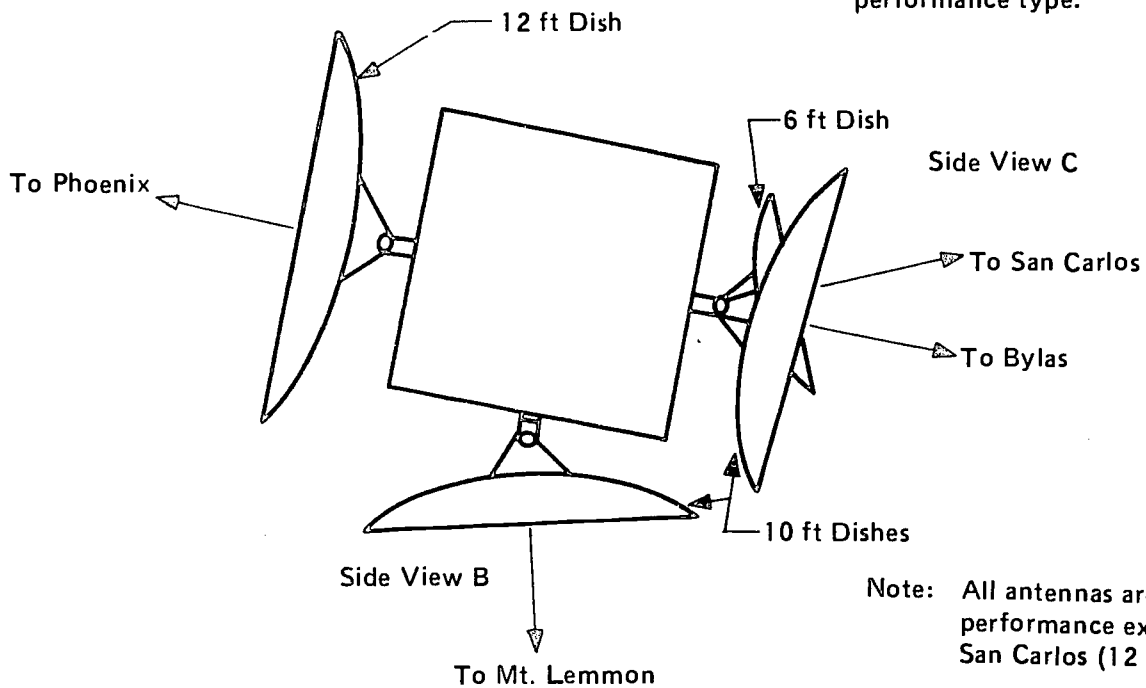

Figure D.54. New Tower and Antenna Arrangement at Mount Lemmon.



NOTE: All dishes are high performance type.



Note: All antennas are high performance except for San Carlos (12 GHz) link.

Figure D.55. New Tower and Antenna Arrangement at Pinal Peak.

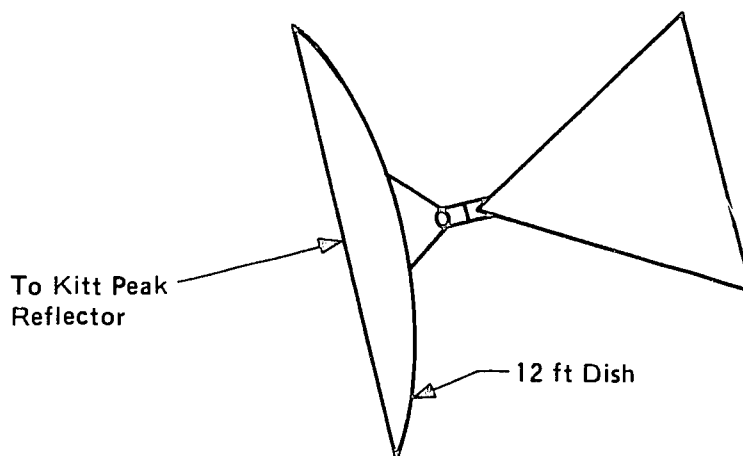
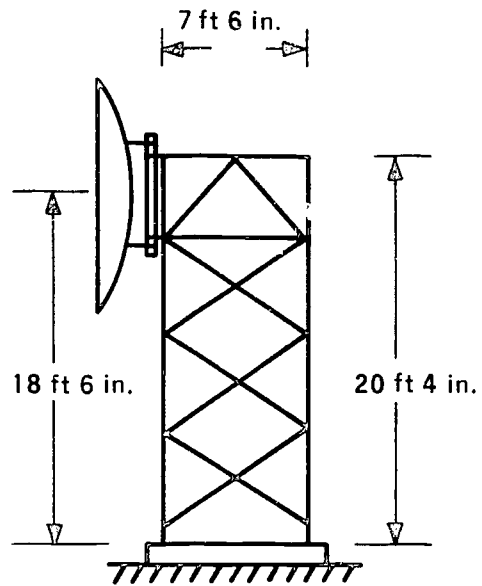

Figure D.56. New Tower and Antenna Arrangement at Santa Rosa.

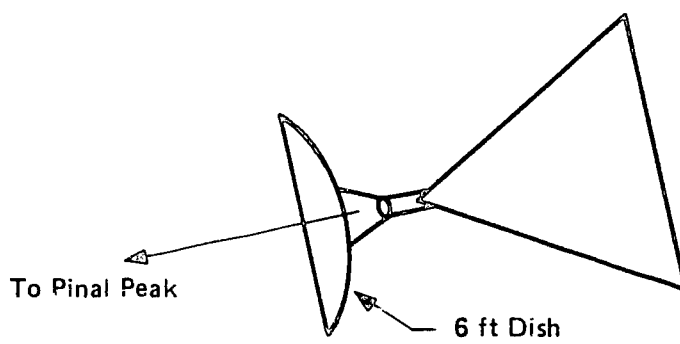
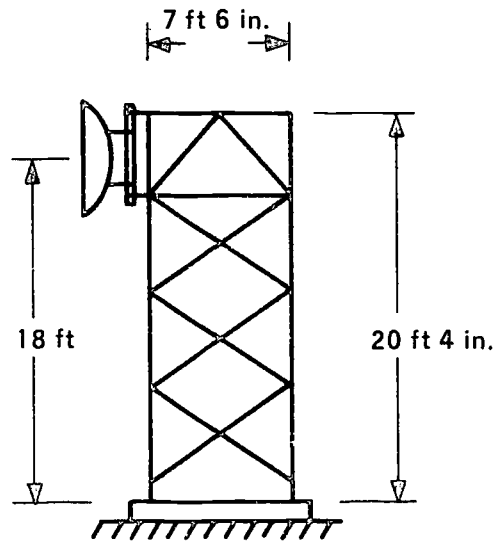

Figure D.57. New Tower and Antenna Arrangement at San Carlos.

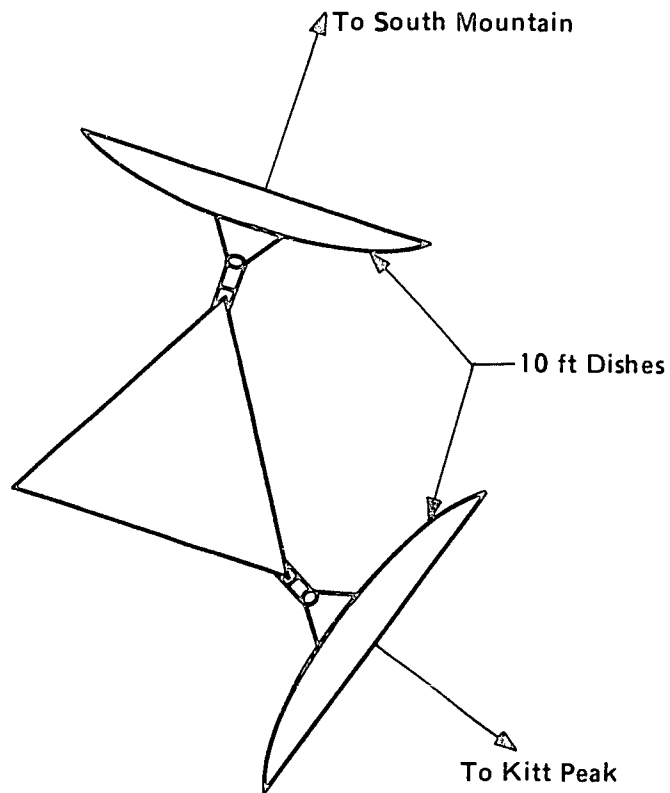
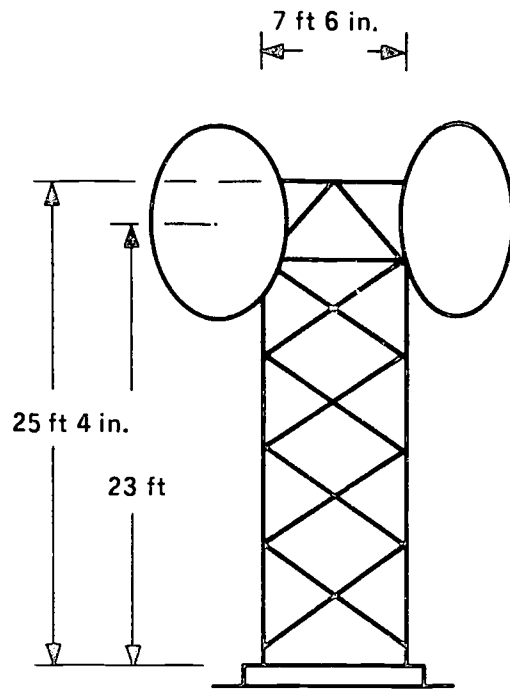

Figure D.58. New Tower and Antenna Arrangements at Cimmaron.

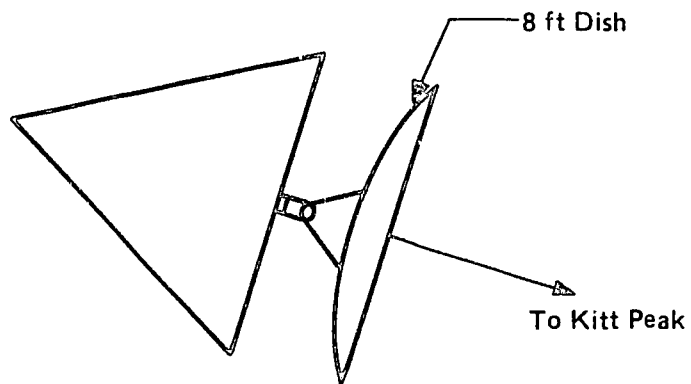
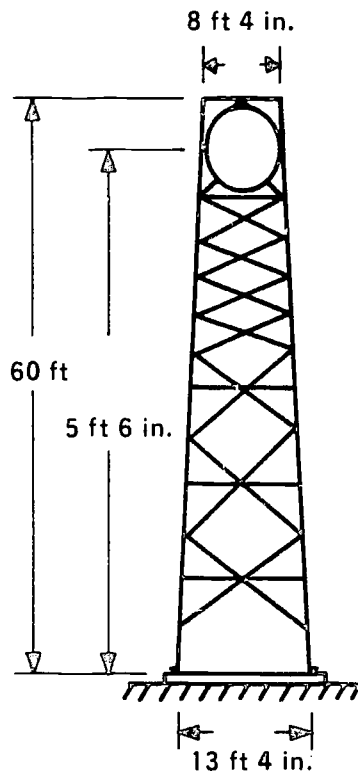

Figure D.59. New Tower and Antenna Arrangement at Pisinimo.

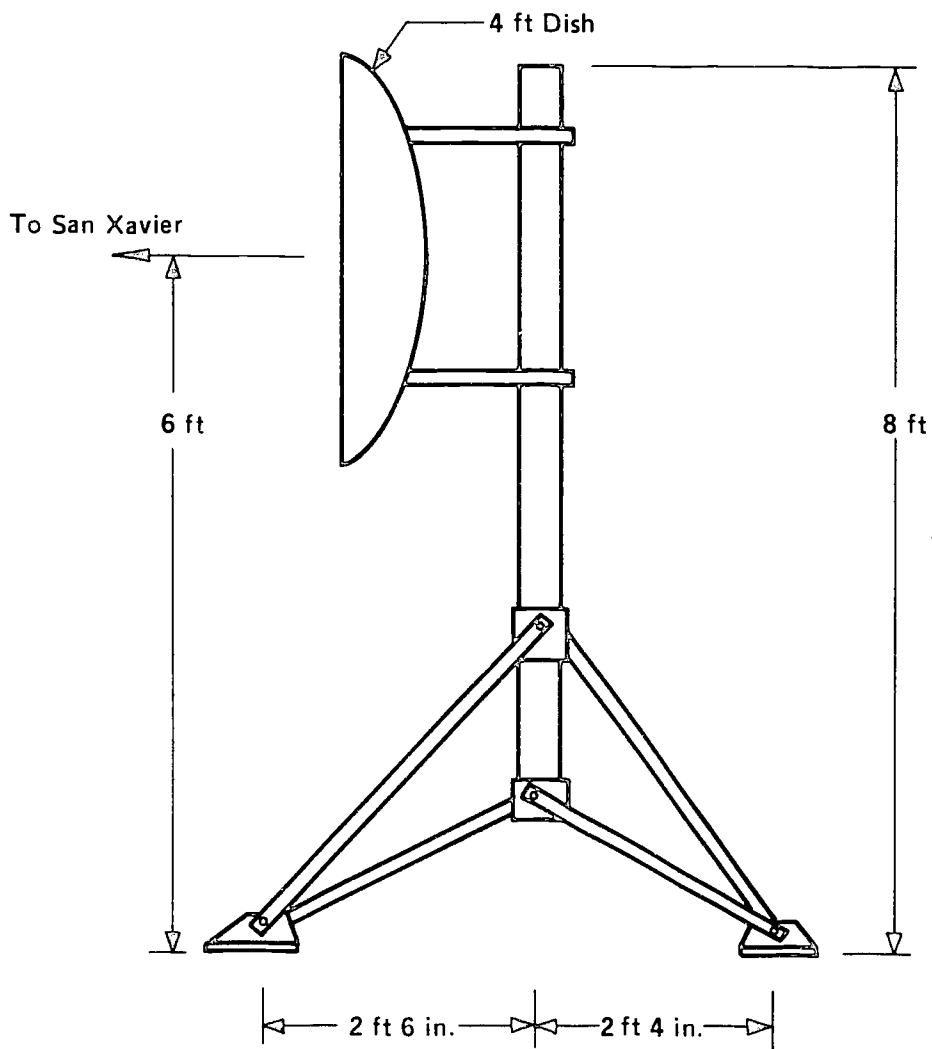

Figure D.60. New Mounting Tripod and Antenna on Roof of University of Arizona Medical Center, Tucson.



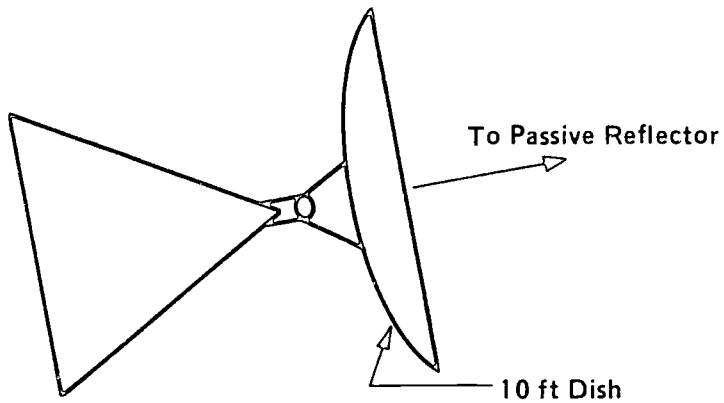
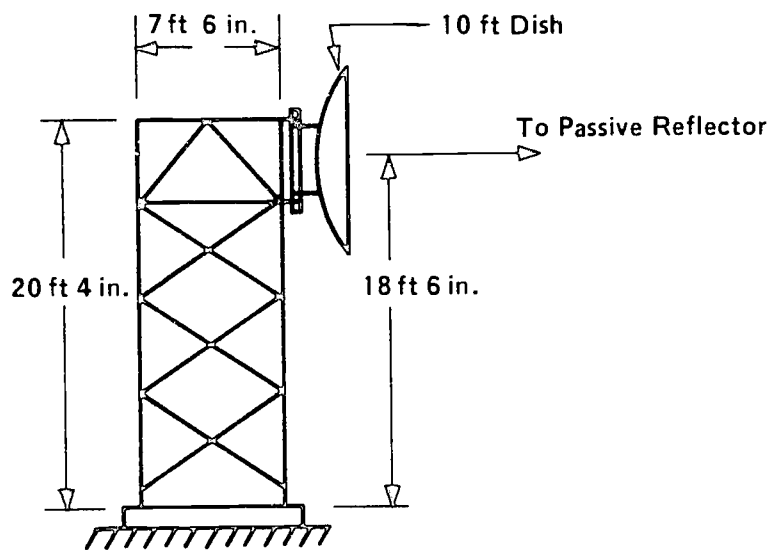

Figure D.61. New Tower and Antenna Arrangement at Bylas.

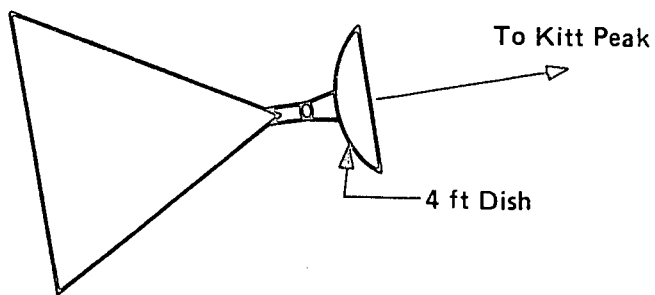
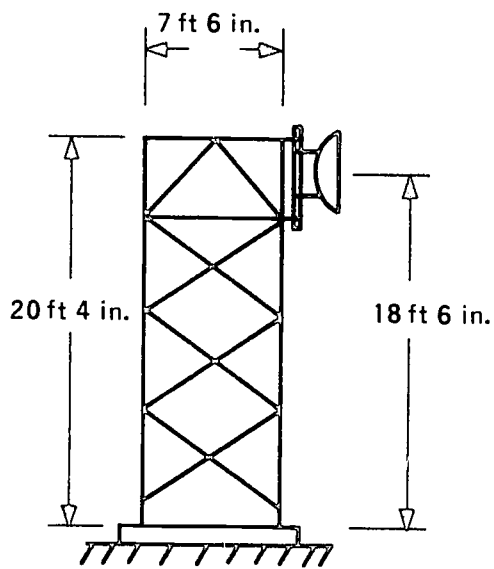

Figure D.62. New Tower and Antenna Arrangement at Sells.